

1. Report No. FHWA/TX-03/4288-1		2. Government Accession No.		3. Recipient's Catalog No.	
4. Title and Subtitle DESIGN AND EVALUATION OF THE TXDOT F411 AND T77 AESTHETIC BRIDGE RAILS				5. Report Date October 2002	
				6. Performing Organization Code	
7. Author(s) D. Lance Bullard, Jr., William F. Williams, Wanda L. Menges, and Rebecca R. Haug				8. Performing Organization Report No. Report 4288-1	
9. Performing Organization Name and Address Texas Transportation Institute The Texas A&M University System College Station, Texas 77843-3135				10. Work Unit No. (TRAIS)	
				11. Contract or Grant No. Project No. 0-4288	
12. Sponsoring Agency Name and Address Texas Department of Transportation Research and Technology Implementation Office P.O. Box 5080 Austin Texas 78763-5080				13. Type of Report and Period Covered Research: September 2001 – August 2002	
				14. Sponsoring Agency Code	
15. Supplementary Notes Research performed in cooperation with the Texas Department of Transportation and the U.S. Department of Transportation, Federal Highway Administration. Research Project Title: Development of Aesthetic Traffic Rails					
16. Abstract The objective of this project was to develop two aesthetically pleasing and crashworthy bridge rails for use by TxDOT. Texas Transportation Institute (TTI) and TxDOT worked cooperatively to conceptualize several aesthetically pleasing rail designs. Researchers performed full-scale crash tests in accordance with <i>National Cooperative Highway Research Program (NCHRP) Report 350</i> . A new aesthetically pleasing bridge rail, the Texas F411 successfully met the evaluation criteria in <i>NCHRP Report 350</i> for Test 3-11 and is ready for implementation. The second aesthetic bridge rail developed, the Texas T77, successfully met the evaluation criteria in <i>NCHRP Report 350</i> for Test 3-10. However, Test 3-11 did not meet the evaluation criteria due to the vehicle snagging at the rail splice joint and thus causing excessive occupant compartment deformation. Additional crash testing on a splice and/or rail modification will be necessary prior to implementing the Texas T77.					
17. Key Words Bridge Rails, Roadside Safety, Aesthetic Rails, Concrete Rails, Longitudinal Barriers			18. Distribution Statement No restrictions. This document is available to the public through NTIS: National Technical Information Service 5285 Port Royal Road Springfield, Virginia 22161		
19. Security Classif.(of this report) Unclassified		20. Security Classif.(of this page) Unclassified		21. No. of Pages 176	22. Price

**DESIGN AND EVALUATION OF THE TxDOT
F411 AND T77 AESTHETIC BRIDGE RAILS**

by

D. Lance Bullard, Jr., P.E.
Associate Research Engineer
Texas Transportation Institute

William F. Williams, P.E.
Assistant Research Engineer
Texas Transportation Institute

Wanda L. Menges
Associate Research Specialist
Texas Transportation Institute

and

Rebecca R. Haug
Assistant Research Specialist
Texas Transportation Institute

Report 4288-1
Project Number 0-4288
Research Project Title: Development of Aesthetic Traffic Rails

Sponsored by the
Texas Department of Transportation
In Cooperation with the
U.S. Department of Transportation
Federal Highway Administration

October 2002

TEXAS TRANSPORTATION INSTITUTE
The Texas A&M University System
College Station, Texas 77843-3135

DISCLAIMER

The contents of this report reflect the views of the authors, who are responsible for the facts and the accuracy of the data presented herein. The contents do not necessarily reflect the official view or policies of the Federal Highway Administration (FHWA) or the Texas Department of Transportation (TXDOT). This report does not constitute a standard, specification, or regulation. The engineer in charge was D. Lance Bullard, Jr., P.E., (Texas, #86872).

ACKNOWLEDGMENTS

This research project was conducted under a cooperative program between the Texas Transportation Institute, the Texas Department of Transportation, and the U.S. Department of Transportation, Federal Highway Administration. The TxDOT project director for this research was Mark Bloschock. His energy, guidance and contributions to the project are acknowledged and greatly appreciated. Texas Transportation Institute acknowledges Mr. Dean Van Landuyt of TxDOT for his conceptual designs of the T77 bridge rail and thanks him for his vision.

TABLE OF CONTENTS

	Page
LIST OF FIGURES	x
LIST OF TABLES	xiii
CHAPTER 1. INTRODUCTION	1
PROBLEM.....	1
BACKGROUND	1
OBJECTIVES/SCOPE OF RESEARCH	2
CHAPTER 2. STUDY APPROACH.....	5
TEST FACILITY	5
TEST ARTICLE DESIGN	5
F411 Bridge Rail.....	5
T77 Bridge Rail.....	6
CRASH TEST CONDITIONS	18
EVALUATION CRITERIA	18
CHAPTER 3. CRASH TEST RESULTS	19
TEST NO. 442882-1 (<i>NCHRP Report 350</i> TEST NO. 3-11) ON THE TXDOT F411 BRIDGE RAIL	19
Test Vehicle	19
Weather Conditions	19
Test Description	19
Damage to Test Installation	22
Vehicle Damage.....	22
Occupant Risk Factors	22
Assessment of Test Results.....	22
TEST NO. 442882-2 (<i>NCHRP Report 350</i> TEST NO. 3-11) ON THE MODIFIED TXDOT F411 BRIDGE RAIL	31
Test Vehicle	31
Weather Conditions	31
Test Description	31
Damage to Test Installation	31
Vehicle Damage.....	34
Occupant Risk Factors	34
Assessment of Test Results.....	34

TABLE OF CONTENTS (CONTINUED)

	Page
TEST NO. 442882-3 (<i>NCHRP Report 350</i> TEST NO. 3-11) ON THE TXDOT T77 BRIDGE RAIL.....	43
Test Vehicle	43
Weather Conditions	43
Test Description.....	43
Damage to Test Installation	43
Vehicle Damage.....	46
Occupant Risk Factors	46
Assessment of Test Results.....	46
TEST NO. 442882-4 (<i>NCHRP Report 350</i> TEST NO. 3-10) ON THE TXDOT T77 BRIDGE RAIL.....	55
Test Vehicle	55
Weather Conditions	55
Test Description.....	55
Damage to Test Installation	55
Vehicle Damage.....	58
Occupant Risk Factors	58
Assessment of Test Results.....	58
CHAPTER 4. SUMMARY AND CONCLUSIONS	67
SUMMARY OF RESULTS	67
F411 Bridge Rail.....	67
T77 Bridge Rail.....	67
CONCLUSIONS.....	68
IMPLEMENTATION STATEMENT	68
REFERENCES	73
APPENDIX A. DESIGN CALCULATIONS FOR F411 BRIDGE RAIL	75
APPENDIX B. DESIGN CALCULATIONS FOR T77 BRIDGE RAIL	91
APPENDIX C. CRASH TEST PROCEDURES AND DATA ANALYSIS.....	107
ELECTRONIC INSTRUMENTATION AND DATA PROCESSING	107
ANTHROPOMORPHIC DUMMY INSTRUMENTATION.....	108
PHOTOGRAPHIC INSTRUMENTATION AND DATA PROCESSING	108
TEST VEHICLE PROPULSION AND GUIDANCE.....	108
APPENDIX D. TEST VEHICLE PROPERTIES AND INFORMATION	111
APPENDIX E. SEQUENTIAL PHOTOGRAPHS	123

TABLE OF CONTENTS (CONTINUED)

	Page
APPENDIX F. VEHICLE ANGULAR DISPLACEMENTS AND ACCELERATIONS	135

LIST OF FIGURES

Figure		Page
1	Details of the TxDOT F411 Bridge Rail.....	7
2	TxDOT F411 Bridge Rail before Test 442882-1.....	9
3	TxDOT F411 Bridge Rail before Test 442882-2.....	10
4	Details of the TxDOT T77 Bridge Rail.....	12
5	TxDOT F411 Bridge Rail before Test 442882-3 and 4.....	17
6	Vehicle/Bridge Rail Geometrics for Test 442882-1.....	20
7	Vehicle before Test 442882-1.....	21
8	After Impact Trajectory for Test 442882-1.....	23
9	Installation after Test 442882-1.....	24
10	Vehicle after Test 442882-1.....	25
11	Interior of Vehicle for Test 442882-1.....	26
12	Summary of Results for Test 442882-1, <i>NCHRP Report 350 Test 3-11</i>	27
13	Vehicle/Bridge Rail Geometrics for Test 442882-2.....	32
14	Vehicle before Test 442882-2.....	33
15	After Impact Trajectory for Test 442882-2.....	35
16	Installation after Test 442882-2.....	36
17	Vehicle after Test 442882-2.....	37
18	Interior of Vehicle for Test 442882-2.....	38
19	Summary of Results for Test 442882-2, <i>NCHRP Report 350 Test 3-11</i>	39
20	Vehicle/Bridge Rail Geometrics for Test 442882-3.....	44
21	Vehicle before Test 442882-3.....	45
22	After Impact Trajectory for Test 442882-3.....	47
23	Installation after Test 442882-3.....	48
24	Vehicle after Test 442882-3.....	49
25	Interior of Vehicle for Test 442882-3.....	50
26	Summary of Results for Test 442882-3, <i>NCHRP Report 350 Test 3-11</i>	51
27	Vehicle/Bridge Rail Geometrics for Test 442882-4.....	56
28	Vehicle before Test 442882-4.....	57
29	After Impact Trajectory for Test 442882-4.....	59
30	Installation after Test 442882-4.....	60
31	Vehicle after Test 442882-4.....	61
32	Interior of Vehicle for Test 442882-4.....	62
33	Summary of Results for Test 442882-4, <i>NCHRP Report 350 Test 3-10</i>	63
34	Vehicle Properties for Test 442882-1.....	111
35	Vehicle Properties for Test 442882-2.....	114
36	Vehicle Properties for Test 442882-3.....	117
37	Vehicle Properties for Test 442882-4.....	120
38	Sequential Photographs for Test 442882-1 (Overhead and Frontal Views).....	123
39	Sequential Photographs for Test 442882-1 (Rear View).....	125

LIST OF FIGURES (CONTINUED)

Figure		Page
40	Sequential Photographs for Test 442882-2 (Overhead and Frontal Views).....	126
41	Sequential Photographs for Test 442882-2 (Rear View).....	128
42	Sequential Photographs for Test 442882-3 (Overhead and Frontal Views).....	129
43	Sequential Photographs for Test 442882-3 (Rear View).....	131
44	Sequential Photographs for Test 442882-4 (Overhead and Frontal Views).....	132
45	Sequential Photographs for Test 442882-4 (Rear View).....	134
46	Vehicular Angular Displacements for Test 442882-1.....	135
47	Vehicular Angular Displacements for Test 442882-2.....	136
48	Vehicular Angular Displacements for Test 442882-3.....	137
49	Vehicular Angular Displacements for Test 442882-4.....	138
50	Vehicle Longitudinal Accelerometer Trace for Test 442882-1 (Accelerometer Located at Center of Gravity).....	139
51	Vehicle Lateral Accelerometer Trace for Test 442882-1 (Accelerometer Located at Center of Gravity).....	140
52	Vehicle Vertical Accelerometer Trace for Test 442882-1 (Accelerometer Located at Center of Gravity).....	141
53	Vehicle Longitudinal Accelerometer Trace for Test 442882-1 (Accelerometer Located Over Rear Axle).....	142
54	Vehicle Lateral Accelerometer Trace for Test 442882-1 (Accelerometer Located Over Rear Axle).....	143
55	Vehicle Vertical Accelerometer Trace for Test 442882-1 (Accelerometer Located Over Rear Axle).....	144
56	Vehicle Longitudinal Accelerometer Trace for Test 442882-2 (Accelerometer Located at Center of Gravity).....	145
57	Vehicle Lateral Accelerometer Trace for Test 442882-2 (Accelerometer Located at Center of Gravity).....	146
58	Vehicle Vertical Accelerometer Trace for Test 442882-2 (Accelerometer Located at Center of Gravity).....	147
59	Vehicle Longitudinal Accelerometer Trace for Test 442882-2 (Accelerometer Located Over Rear Axle).....	148
60	Vehicle Lateral Accelerometer Trace for Test 442882-2 (Accelerometer Located Over Rear Axle).....	149
61	Vehicle Vertical Accelerometer Trace for Test 442882-2 (Accelerometer Located Over Rear Axle).....	150
62	Vehicle Longitudinal Accelerometer Trace for Test 442882-3 (Accelerometer Located at Center of Gravity).....	151

LIST OF FIGURES (CONTINUED)

Figure		Page
63	Vehicle Lateral Accelerometer Trace for Test 442882-3 (Accelerometer Located at Center of Gravity).....	152
64	Vehicle Vertical Accelerometer Trace for Test 442882-3 (Accelerometer Located at Center of Gravity).....	153
65	Vehicle Longitudinal Accelerometer Trace for Test 442882-3 (Accelerometer Located Over Rear Axle).....	154
66	Vehicle Lateral Accelerometer Trace for Test 442882-3 (Accelerometer Located Over Rear Axle).....	155
67	Vehicle Vertical Accelerometer Trace for Test 442882-3 (Accelerometer Located Over Rear Axle).....	156
68	Vehicle Longitudinal Accelerometer Trace for Test 442882-4 (Accelerometer Located at Center of Gravity).....	157
69	Vehicle Lateral Accelerometer Trace for Test 442882-4 (Accelerometer Located at Center of Gravity).....	158
70	Vehicle Vertical Accelerometer Trace for Test 442882-4 (Accelerometer Located at Center of Gravity).....	159
71	Vehicle Longitudinal Accelerometer Trace for Test 442882-4 (Accelerometer Located Over Rear Axle).....	160
72	Vehicle Lateral Accelerometer Trace for Test 442882-4 (Accelerometer Located Over Rear Axle).....	161
73	Vehicle Vertical Accelerometer Trace for Test 442882-4 (Accelerometer Located Over Rear Axle).....	162

LIST OF TABLES

Table		Page
1	Performance Evaluation Summary for Test 442882-1, <i>NCHRP Report 350</i> Test 3-11.	69
2	Performance Evaluation Summary for Test 442882-2, <i>NCHRP Report 350</i> Test 3-11.	70
3	Performance Evaluation Summary for Test 442882-3, <i>NCHRP Report 350</i> Test 3-11.	71
4	Performance Evaluation Summary for Test 442882-4, <i>NCHRP Report 350</i> Test 3-10.	72
5	Exterior Crush Measurements for Test 442882-1.	112
6	Occupant Compartment Measurements for Test 442882-1.	113
7	Exterior Crush Measurements for Test 442882-2.	115
8	Occupant Compartment Measurements for Test 442882-2.	116
9	Exterior Crush Measurements for Test 442882-3.	118
10	Occupant Compartment Measurements for Test 442882-3.	119
11	Exterior Crush Measurements for Test 442882-4.	121
12	Occupant Compartment Measurements for Test 442882-4.	122

CHAPTER 1. INTRODUCTION

PROBLEM

Texas Department of Transportation (TxDOT) frequently receives requests from districts and the public to provide aesthetically pleasing traffic rails for use on select bridges and roadways. Such rails are normally installed along designated scenic or historic routes and various types of urban facilities. The Texas T411 is an example of an aesthetic rail that has been very successful and has seen widespread implementation at both the state and national level. Although aesthetic rails are generally more expensive to construct, their cost is only a fraction of the total cost of a bridge. Typically, aesthetic rails such as the Texas T411 are ornate and have an open architecture that may compromise their crashworthiness. If not properly designed, vertical and horizontal openings in these barriers provide the opportunity for vehicle snagging, which can produce undesirable decelerations or occupant compartment intrusion. Historically, traffic barriers have been designed for high-speed facilities applications (i.e., >60 mph) following *National Cooperative Highway Research Program (NCHRP) Report 350* Test Level 3 (TL-3) impact conditions (1). However, many locations in which an aesthetic rail is desired have travel speeds of 45 mph or less. The flexibility in geometric design is dictated by the desired design impact conditions. Potentially more crashworthy traffic rail design options may be available for low-speed designs (e.g., Test Level 2 impact conditions) than for high-speed designs (TL-3).

BACKGROUND

The environmental impacts of a roadway are often the dominant characteristics perceived by the community living in its immediate vicinity. Often when community members living near a new highway structure are asked to rank the most important characteristics of the facility, they respond with “noise, fumes, and appearance” as the top three characteristics.

In 1997, Acting Federal Highway Administrator Jane F. Garvey noted that Congress made a strong national commitment to safety and mobility at the same time it made a commitment to preserve and protect the environmental and cultural values affected by transportation facilities. Ms. Garvey stated, “The challenge to the highway design community is to find design solutions, as well as operational options, that result in full consideration of these sometimes conflicting objectives. Design can and must play a major role in enhancing the quality of our journeys and [those] of the communities.” Today many efforts are underway to preserve historic roads and make new aesthetically pleasing highway environments. The National Task Force for Historic Roads (NTFHR) is housed within the Rural Heritage Program at the National Trust for Historic Preservation in Washington, D.C. The purpose of the NTFHR is to promote the recognition of historic roads—esthetic, engineered, and cultural—as well as routes of significant historic interest in the U.S. In addition, the NTFHR advocates the protection of their integrity of design, purpose, and use in a manner that is both historically appropriate and responsive to modern safety needs. To date, much of the prior literature related to the aesthetic considerations of roadside hardware has been focused on historic preservation. In

1997, the Federal Highway Administration (FHWA) joined forces with American Association of State Highway Transportation Officials (AASHTO) and other interest groups to design a companion guide to the Green Book (2) entitled “Flexibility in Highway Design” published in September 1997 (3). The concepts expressed in the guide reflected the mission, goals, and direction of FHWA’s strategic plan. In summary, “Flexibility in Highway Design” came about because of Rodney Slater. Rodney Slater, first as Federal Highway Administrator and later as Secretary of Transportation, has repeatedly stated, “Transportation is more than concrete, steel and asphalt - it is about people.”

As previously stated, TxDOT frequently receives requests to provide aesthetically pleasing traffic rails for use on select bridges and roadways. TxDOT, in response to providing context sensitive design alternatives, initiated this project to develop additional aesthetically pleasing rail alternatives. The Texas T411 is an example of an aesthetic rail that has been very successful and has seen widespread implementation at both the state and national level. Aesthetic rails such as the Texas T411 are ornate, have an open architecture, and are often low in height to permit motorists to see through or over them, all features which may compromise their crashworthiness. For performance along high-speed roadways, designers avoid low-profile rails and rails with large window-type openings. Low-profile rails often do not possess the redirective capabilities necessary to contain and redirect larger automobiles traveling 62 mph (100 km/h). Additionally, openings and small rail set back distances from support posts provide an undesirable geometry and can facilitate “snagging” the vehicle and produce large occupant compartment deformations and high accelerations on the occupants. Historically, traffic barriers have been designed for high-speed facilities applications (i.e., >60 mph) following *NCHRP Report 350* TL-3 impact conditions. However, many locations in which an aesthetic rail is desired have travel speeds of 45 mph or less. The flexibility in geometric design is dictated by the desired design impact conditions. More design options are feasible for low-speed designs (e.g., Test Level 2 impact conditions) than for high-speed designs (TL-3).

The FHWA has successfully developed and tested aesthetically pleasing rails and guardwalls to *NCHRP Report 350*, such as the Steel-Backed Timber Guardrail (4, 5) and the Concrete-Core Stone Masonry Guardwall (6). In the past, the Precast Simulated Stone Guardwall (7), the Glue-Laminated Wood Bridge Rail (8, 9), the Modified Kansas Corral Bridge Railing (10), and the Columbia River Gorge Guardrail (11) are a few of the aesthetic rails that were tested in accordance with *NCHRP Report 230* (12).

OBJECTIVES/SCOPE OF RESEARCH

The objective of this project was to develop two aesthetically pleasing and crashworthy bridge rails for use by TxDOT. Consideration was given to both high-speed and low-speed designs. Texas Transportation Institute (TTI) and TxDOT worked cooperatively to conceptualize several aesthetically pleasing rail designs. Researchers performed full-scale crash tests in accordance with *NCHRP Report 350*. They recommended two crash tests for each prototype bridge rail with an option to perform a third test. The first two crash tests were conducted to validate the bridge rail to meet the requirements of TL-3 conditions as defined in

NCHRP Report 350. Upon approval by TxDOT, optional tests would be performed as necessary for TL-3 acceptance or for validation of Test Level 4.

The objective of this project was to develop two aesthetically pleasing and crashworthy bridge rails for use by TxDOT. Texas Transportation Institute and TxDOT worked cooperatively to conceptualize several aesthetically pleasing rail designs. Researchers performed full-scale crash tests in accordance with *National Cooperative Highway Research Program Report 350*.

CHAPTER 2. STUDY APPROACH

TEST FACILITY

The Texas Transportation Institute Proving Ground is a 2000-acre (809-hectare) complex of research and training facilities located 10 mi (16 km) northwest of the main campus of Texas A&M University. The site, formerly an Air Force base, has large expanses of concrete runways and parking aprons well suited for experimental research and testing in the areas of vehicle performance and handling, vehicle-roadway interaction, durability and efficacy of highway pavements, and safety evaluation of roadside safety hardware. The site selected for placing of the bridge rail is along a wide out-of-service apron. The apron consists of an unreinforced jointed concrete pavement in 12.5 ft by 15 ft (3.8 m by 4.6 m) blocks nominally 8-12 inches (203-305 mm) deep. The aprons and runways are about 50 years old, and the joints have some displacement, but are otherwise flat and level.

TEST ARTICLE DESIGN

TTI met with TxDOT personnel to prioritize and define key aesthetic bridge rail features. From these defined features, TTI developed several conceptual aesthetically pleasing bridge rail designs for review by TxDOT personnel. Additionally, TxDOT presented a conceptual design to TTI for review. Ultimately, TxDOT elected to select the Texas T411 bridge rail for design modification to make the rail perform at *NCHRP Report 350* Test Level 3. The modified T411 will herein be referred to as the F411. Additionally, TxDOT personnel conceptualized the second rail design chosen for development and crash testing, herein referred to as the T77. The F411 and T77 were the two conceptual traffic rail designs selected for detailed design and crash testing.

TTI performed detailed design calculations to determine the structural requirements for the two bridge rails. These calculations were performed in accordance with the AASHTO LRFD Bridge Design Specifications (13). Test Level Four (TL-4) was initially selected for establishing structural design loads. However due to a preference by TxDOT to not bolt through the curb for anchoring the posts, the T77 does not fully meet the TL-4 load requirements and is considered for design purposes TL-3. The F411 does meet TL-4 design load requirements. Appendices A and B present the calculations for the design of each bridge rail. Detailed design drawings were developed and submitted to TxDOT for review. Upon approval by TxDOT, TTI proceeded to fabricate full-scale test installations.

F411 Bridge Rail

The TxDOT F411 was the first prototype concrete aesthetic bridge designed, constructed, and crash tested under this project. Design calculations for the bridge rail are provided in [Appendix A](#). The TxDOT F411 bridge rail is a 10 inch (254 mm) wide by 3 ft-6 inch (1.1 m) high parapet wall with two 6 inch (152 mm) wide concrete rails that project 6 inches (152 mm)

toward the traffic side. Considering the shape and location of the two concrete rails, the cross section of the F411 closely resembles the shape of the letter “F.” The height of the lower rail is 1 ft-6 inches (0.5 m) from the top of the deck. The height of the upper rail is 3 ft-6 inches (1.1 m) from the top of the deck. The total width of the rail at the top is 1 ft-4 inches (0.4 m). In addition, the rail was constructed with square aesthetic openings located between the projecting rails. These openings were 6 inches by 11 inches (279 mm) and were spaced 1 ft-6 inches (0.5 m) apart along the entire length of the 76-ft (23.2 m) long test specimen.

The rail was constructed atop an 8 inch (203 mm) thick by 2 ft-5 inch (0.7 m) wide bridge deck cantilever. Vertical reinforcement in the rail consisted of two #5 enclosed “S” Bars spaced 6 inches (152 mm) apart in the 12 inch by 10 inch (305 mm by 254 mm) posts. These bars were approximately 3 ft-4 inches (1.0 m) long and reinforced the entire height of the rail. In addition to the “S” Bars, #3 “W” bars reinforced the 6 inch by 6 inch (152 mm by 152 mm) projecting rail and these bars were located 6 inches (152 mm) apart along the length of the installation. Longitudinal reinforcement consisted of three #5 bars at each projecting rail location with two #5 bars located with the “S” Bars at the base of the rail. The rail was anchored to the concrete deck cantilever by #5 “U” Bars spaced 9 inches (229 mm) apart which projected upward approximately 8 inches (203 mm) from the top of the deck cantilever into the base of the rail. Transverse reinforcement in the deck cantilever consisted of #5 bars spaced 6 inches (152 mm) apart in the top and bottom layers. Longitudinal reinforcement in the bottom layer of the deck cantilever consisted of two #5 bars spaced 3 inches (76 mm) apart near the field side edge with a third adjacent bar spaced 12 inches (305 mm) away. Longitudinal reinforcement in the top layer of the deck cantilever consisted of #4 bars spaced 9 inches (229 mm) apart. All reinforcement was bare steel (not epoxy coated) and had a minimum yield strength of 60 ksi. Concrete compressive strength tests performed on the day the test was performed on samples taken from pours made on the deck and rail revealed compressive strengths of 5399 psi and 4341 psi, respectively.

Test 442882-1 yielded unsatisfactory results. As a result, a modification was made to the F411 Bridge Rail to improve performance. The rail was modified by enclosing the open space beneath the lower rail with concrete, thus making it flush. Enclosing the bottom of the rail increased the effective surface contact area of the installation. Please refer to the drawings shown in [Figure 1](#) for additional details. [Figures 2](#) and [3](#) show photographs of the completed installations.

T77 Bridge Rail

TTI designed, constructed, and crash tested a prototype steel aesthetic bridge rail designated as TxDOT Type T77. [Appendix B](#) presents design calculations for the bridge rail. The total length of the railing installation was 75 ft (22.7 m). The T77 bridge railing system is a steel rail and post system consisting of two tubular steel rail elements mounted on 1-1/4 inch (32 mm) thick steel plate posts spaced 8 ft (2.4 m) apart. The elliptical-shaped rails were 8 inch × 4-7/8 inch (203 mm × 124 mm) and were manufactured from 6 inch (152 mm) diameter, API-5LX52 pipe with a wall thickness of 0.188 inch (20 mm). The center of the lower rail and the top of the upper rail measured 1 ft-6-inches (0.45 m) and 2 ft-9 inches (0.8 m), respectively, from

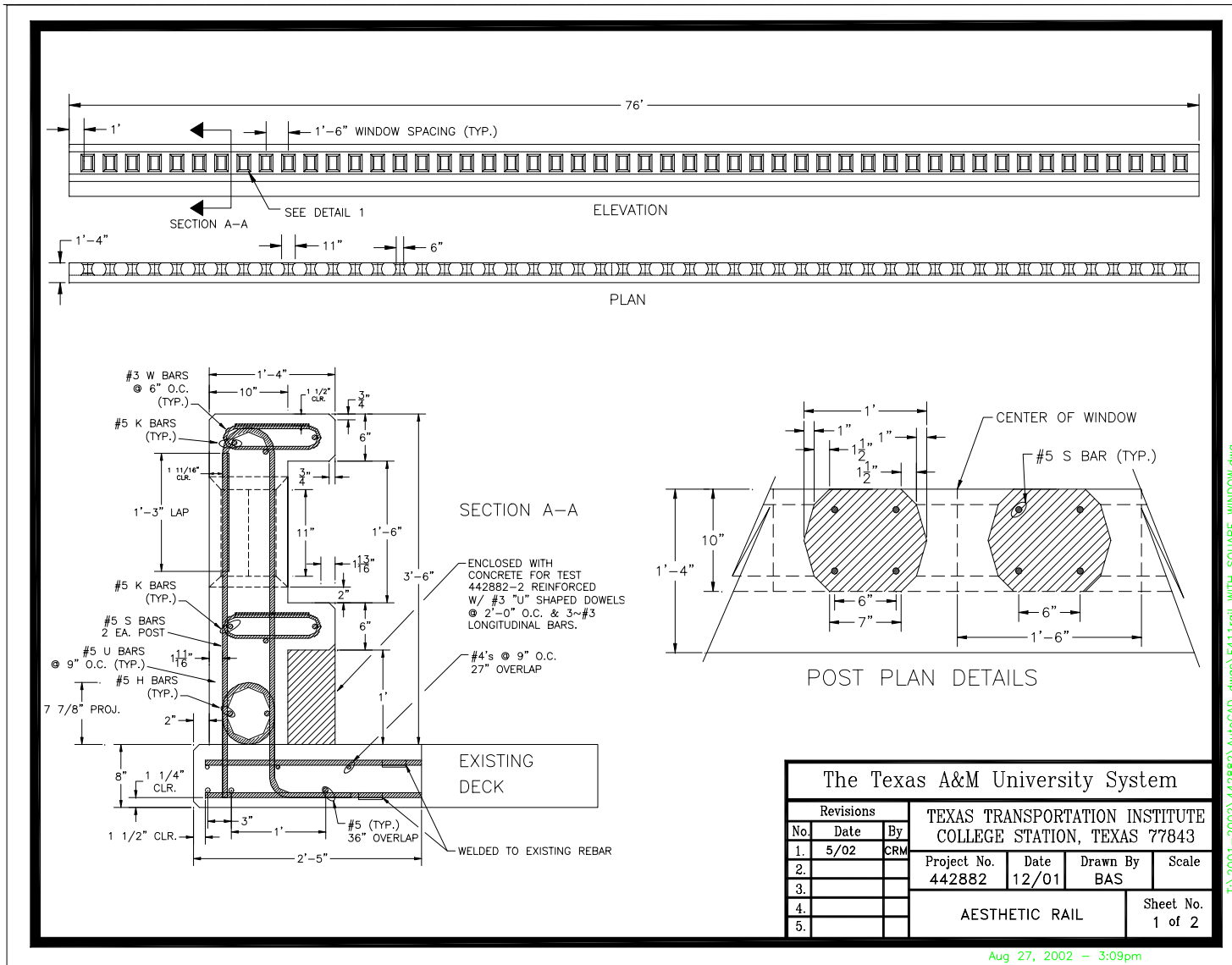


Figure 1. Details of the TxDOT F411 Bridge Rail.

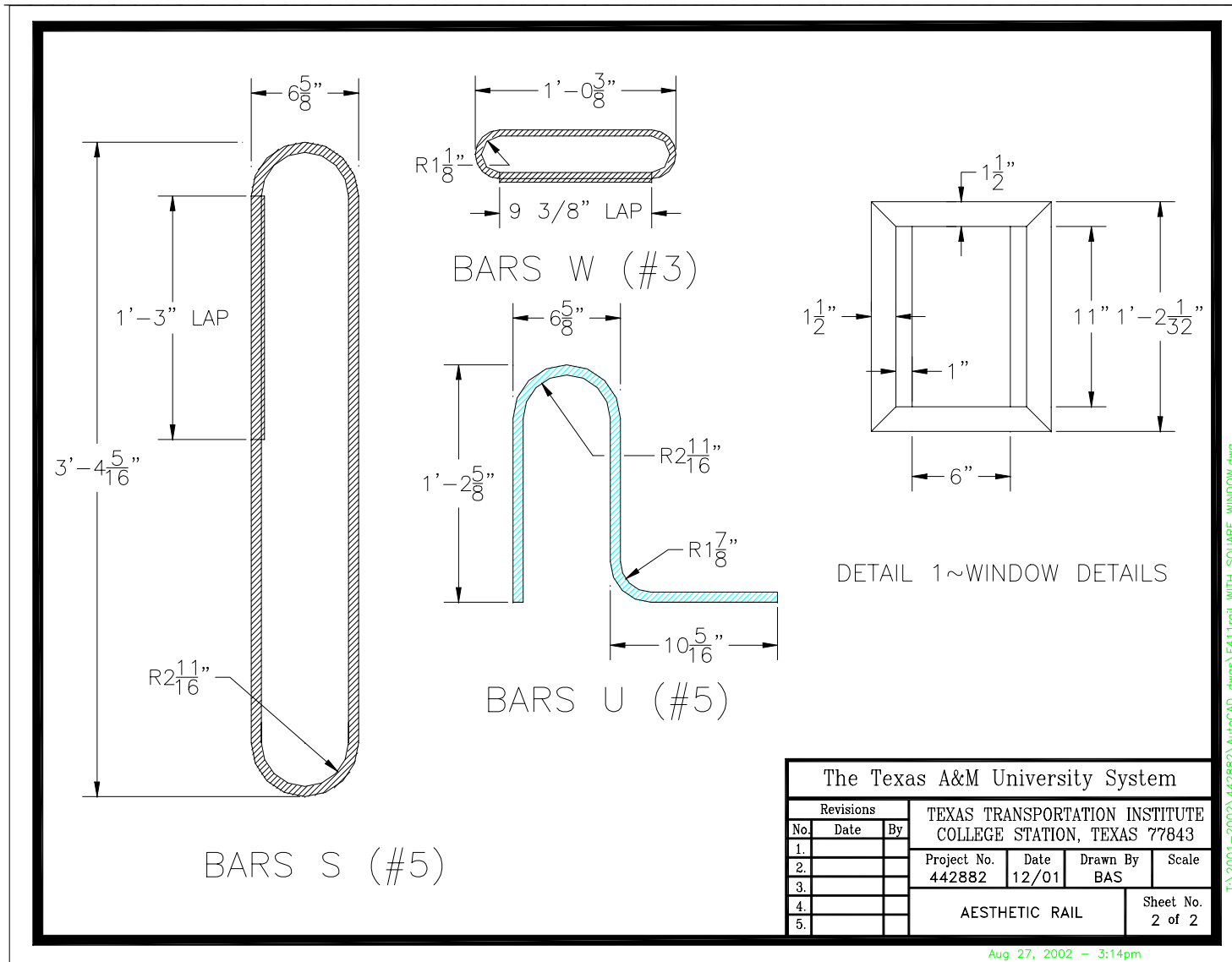


Figure 1. Details of the TxDOT F411 Bridge Rail (Continued).



Figure 2. TxDOT F411 Bridge Rail before Test 442882-1.

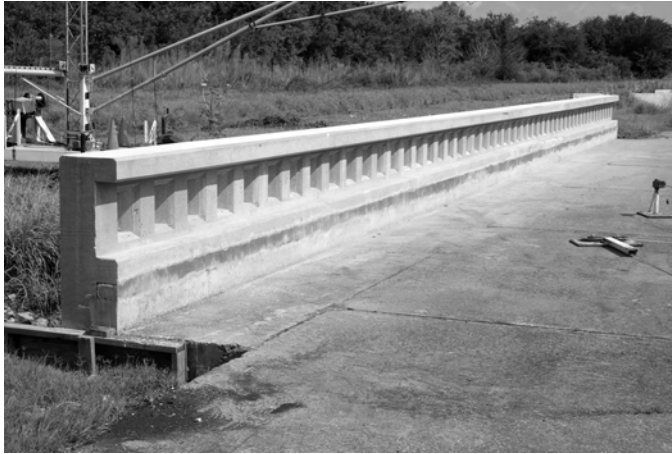


Figure 3. TxDOT F411 Bridge Rail before Test 442882-2.

the pavement surface. The rails were welded to the posts. The 1-1/4 inch (32 mm) thick posts were fabricated in the shape of the numeral “7” and were welded 11-1/2 inch × 12 inch × 1-1/2 inch (292 mm × 305 mm × 38 mm) thick baseplates. Each post was anchored to the curb using four 7/8 inch (22 mm) diameter A325 anchor bolts with a 7 inch × 11 inch × 1/4 inch (178 mm × 279 mm × 6 mm) thick anchor plate used for additional anchorage. The bridge railing system was supported by a cast-in-place concrete deck and curb. The curb was 14 inches (356 mm) wide and 9 inches (229 mm) high on the traffic side and 5-1/2 inches (140 mm) high on the field side. The top of the curb sloped downward approximately 14 degrees from horizontal toward the field side. The post plates were sloped in a similar fashion so that the two rail elements were flush with the traffic side face of the curb. The post plates and base plates were manufactured from A572 grade 50 steel. Gordon Specialities, Inc., of Hutchins, Texas, fabricated the bridge rail. TTI fabricated the anchor plates.

The railing installation was constructed using 2 ft (0.6 m) long elliptical-shaped sleeve splices which were also manufactured from 6 inch (152 mm) diameter API-5LX52 pipe formed into an 8 inch × 4-7/8 inch (203 mm × 124 mm) elliptical shape. To obtain a secure fit of these splices inside the elliptical rail pipe, small arch segments were removed from the upper and lower areas of each splice sleeve with the two halves welded together to obtain a secure fit inside the rails. The splices were constructed with a close fitting tolerance and provided approximately 1-1/4 inch of rail expansion at each splice. These splices were located 1 ft (0.3 m) from posts 4 and 7.

A simulated concrete bridge deck cantilever and curb was constructed immediately adjacent to an existing concrete runway located at the TTI test facility. The total length of the installation was 75 ft (22.9 m). The bridge deck cantilever was 2 ft-5 inches (0.7 m) in width and 8 inches (203 mm) thick and was rigidly attached to an existing concrete foundation at the testing facility. A 1 ft-2 inch (0.4 m) wide concrete curb, 9 inches (229 mm) high on the traffic side and 5-1/2 inches (140 mm) wide on the field side was cast on top of the concrete deck. Transverse reinforcement in the deck consisted of two layers of #5's spaced 6 inches (152 mm) apart. Longitudinal reinforcement in the top layer of the deck consisted of two #4's spaced 10 inches (254 mm) apart closest to the field side edge with a third bar located approximately 6-3/4 inches (171 mm) away. Longitudinal reinforcement in the bottom layer of the deck consisted of two #5's located 3 inches (76 mm) apart closest to the field side edge with a third #5 bar located approximately 12 inches (305 mm) away. In addition to the deck reinforcement, #5 hoop-shaped “U” bars located 6 inches (152 mm) apart were cast in the deck for reinforcement for the concrete curb. Longitudinal reinforcement in the curb consisted of two #5 bars equally spaced in the top of the “U” Bars. All reinforcement used in the top layer of the deck was epoxy coated. All other reinforcement was bare steel (not epoxy coated). All reinforcement was specified to have a minimum yield strength of 60 ksi.

Standard concrete compressive strength cylinders were cast for both the concrete deck and curb. For the concrete deck, strength tests performed at 11 days age resulted in an average compressive strength of 4155 psi. For the concrete curb, strength tests performed at 7 days age resulted in an average compressive strength of 3728 psi. [Figure 4](#) provides additional details. [Figure 5](#) shows photographs of the completed installations.

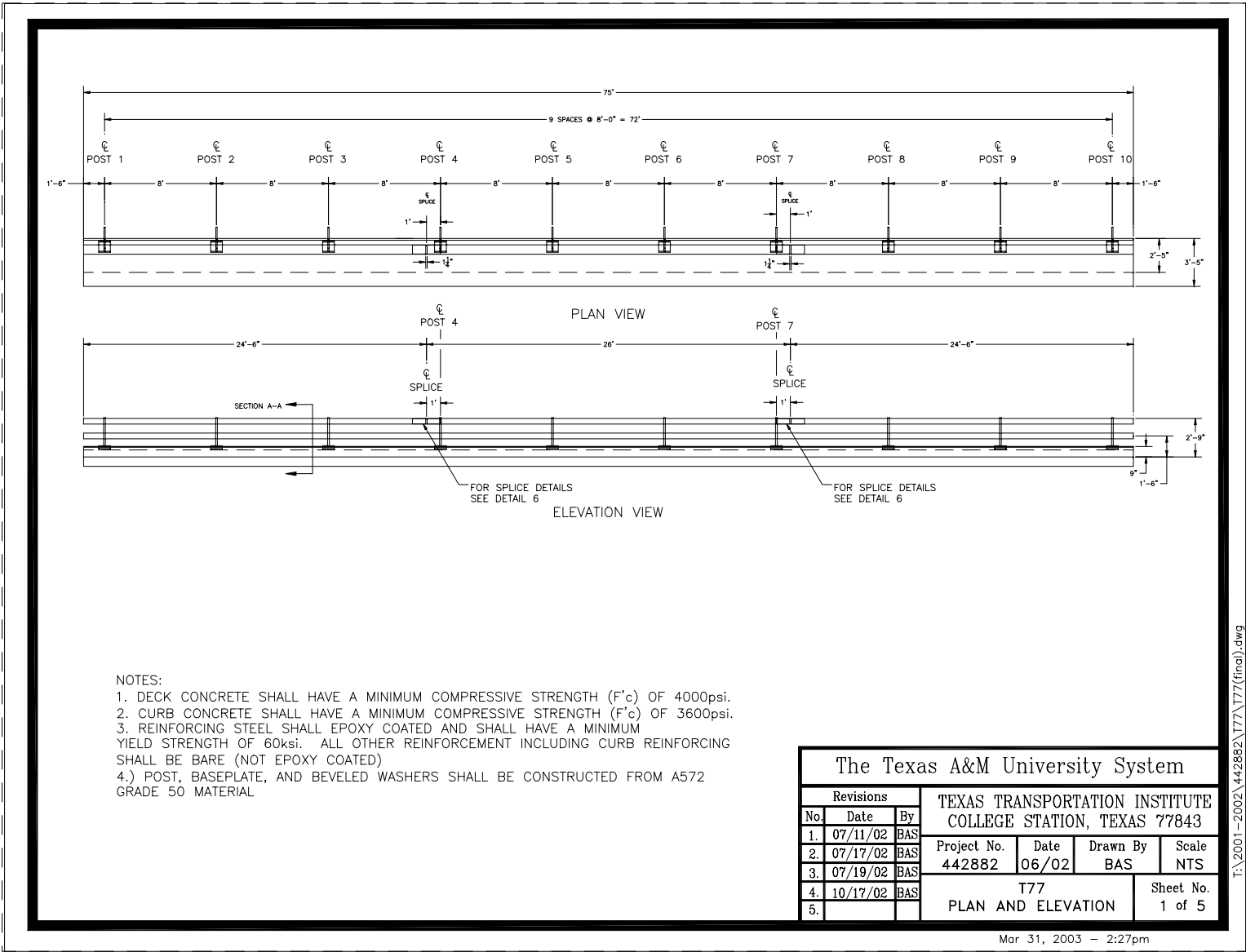
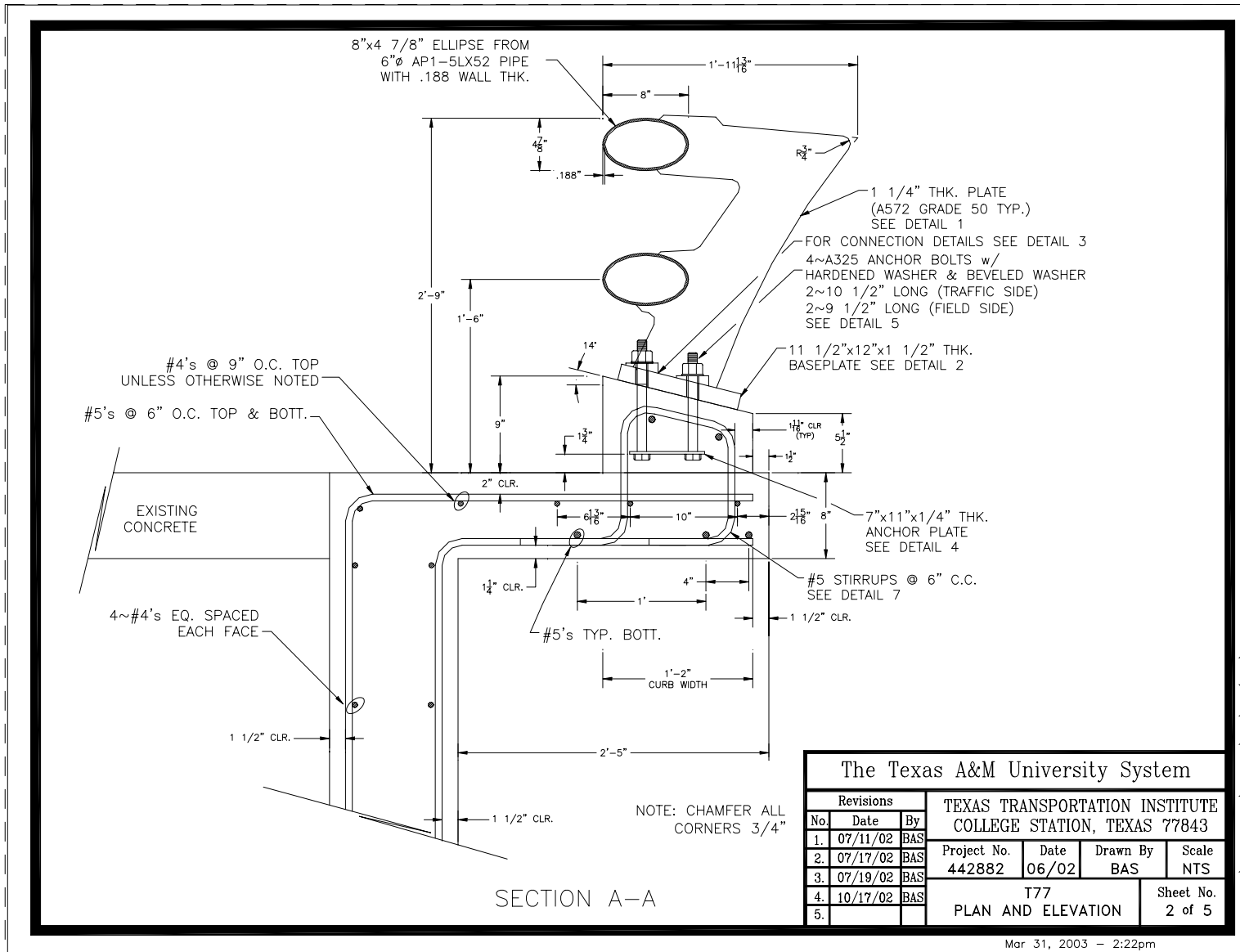


Figure 4. Details of the TxDOT T77 Bridge Rail.



The Texas A&M University System			
TEXAS TRANSPORTATION INSTITUTE COLLEGE STATION, TEXAS 77843			
Project No.		Date	Drawn By
442882		06/02	BAS
Scale		NTS	
T77 PLAN AND ELEVATION			Sheet No. 2 of 5

T:\2001-2002\442882\T77\T77(final).dwg

Figure 4. Details of the TxDOT T77 Bridge Rail (Continued).

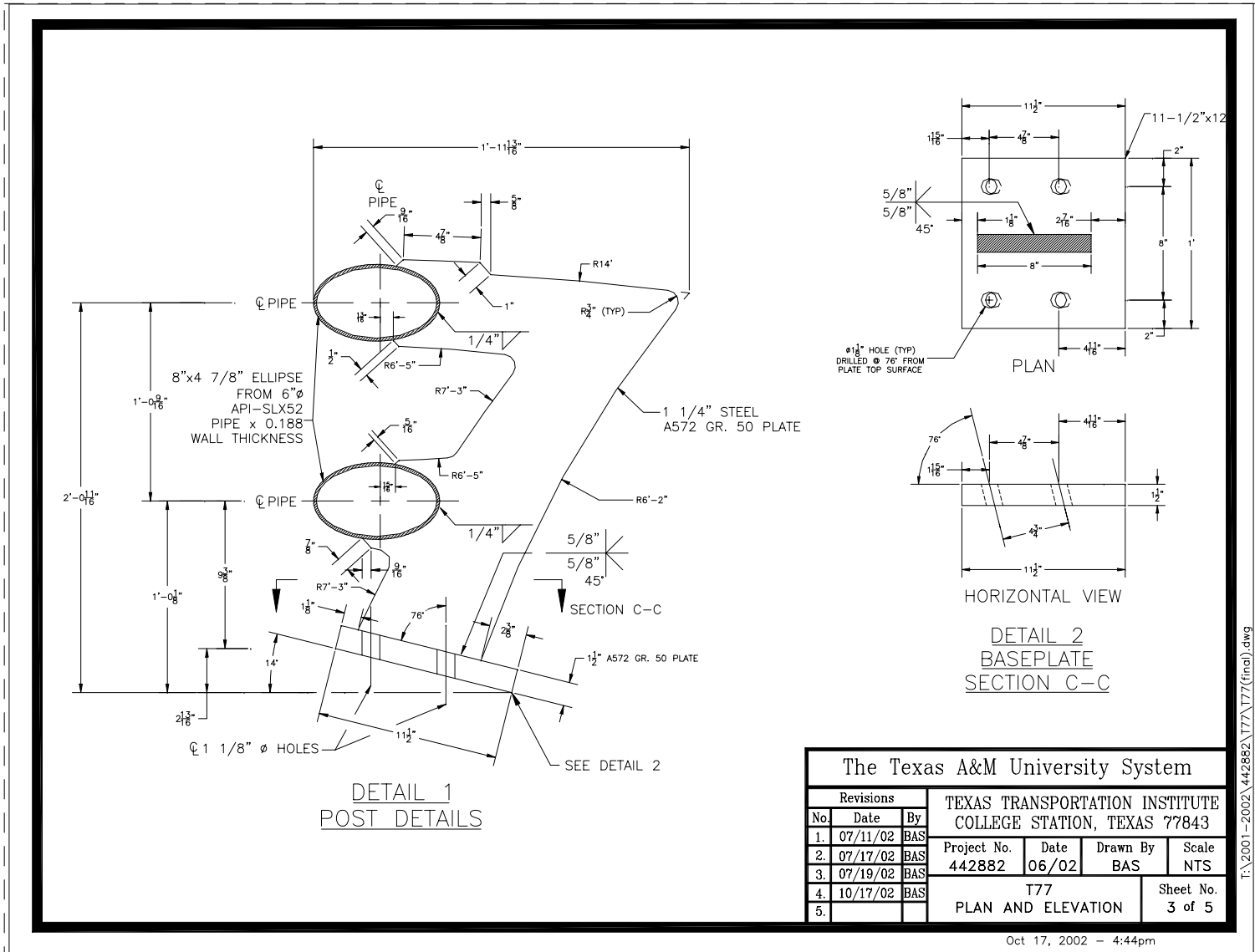


Figure 4. Details of the TxDOT T77 Bridge Rail (Continued).

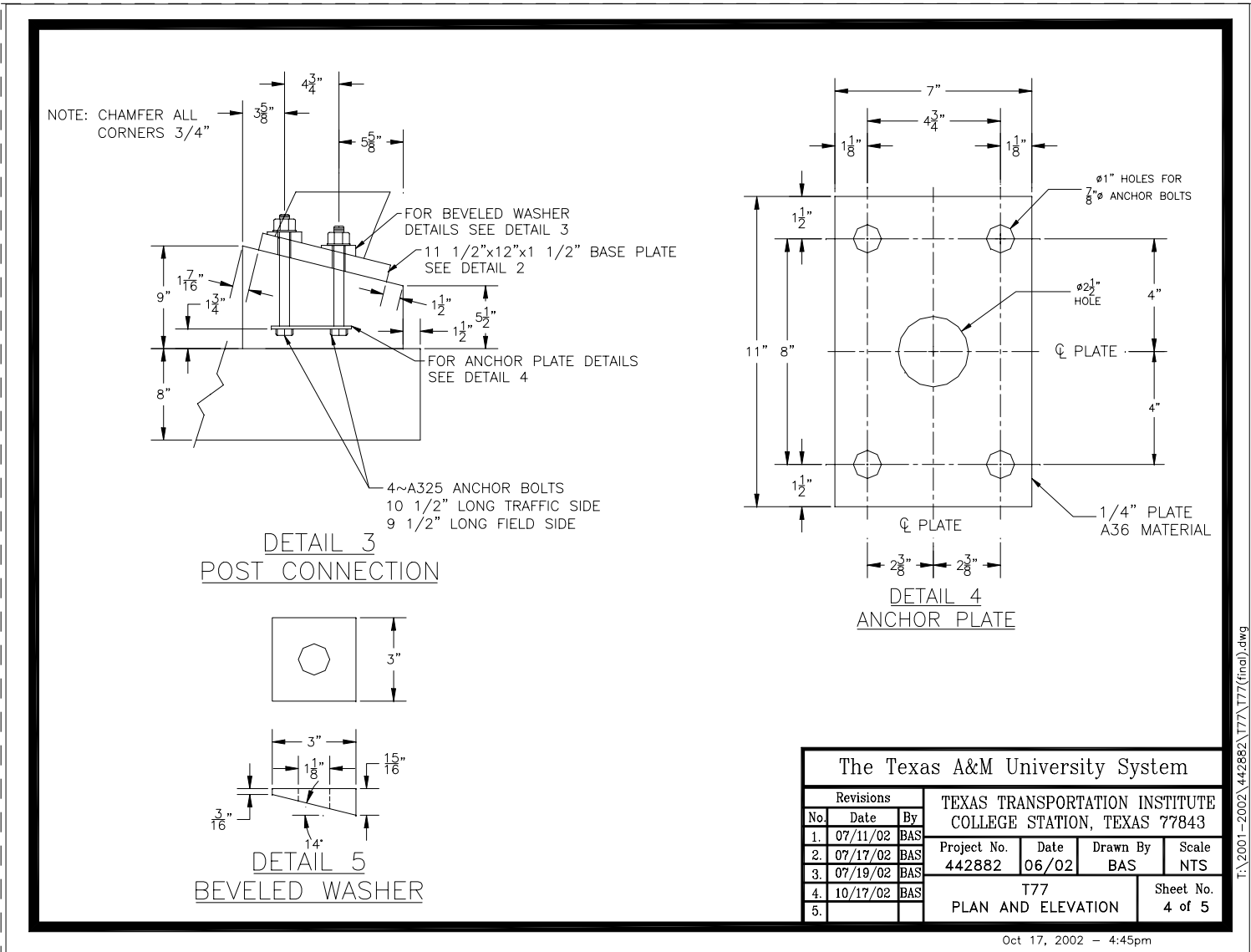


Figure 4. Details of the TxDOT T77 Bridge Rail (Continued).

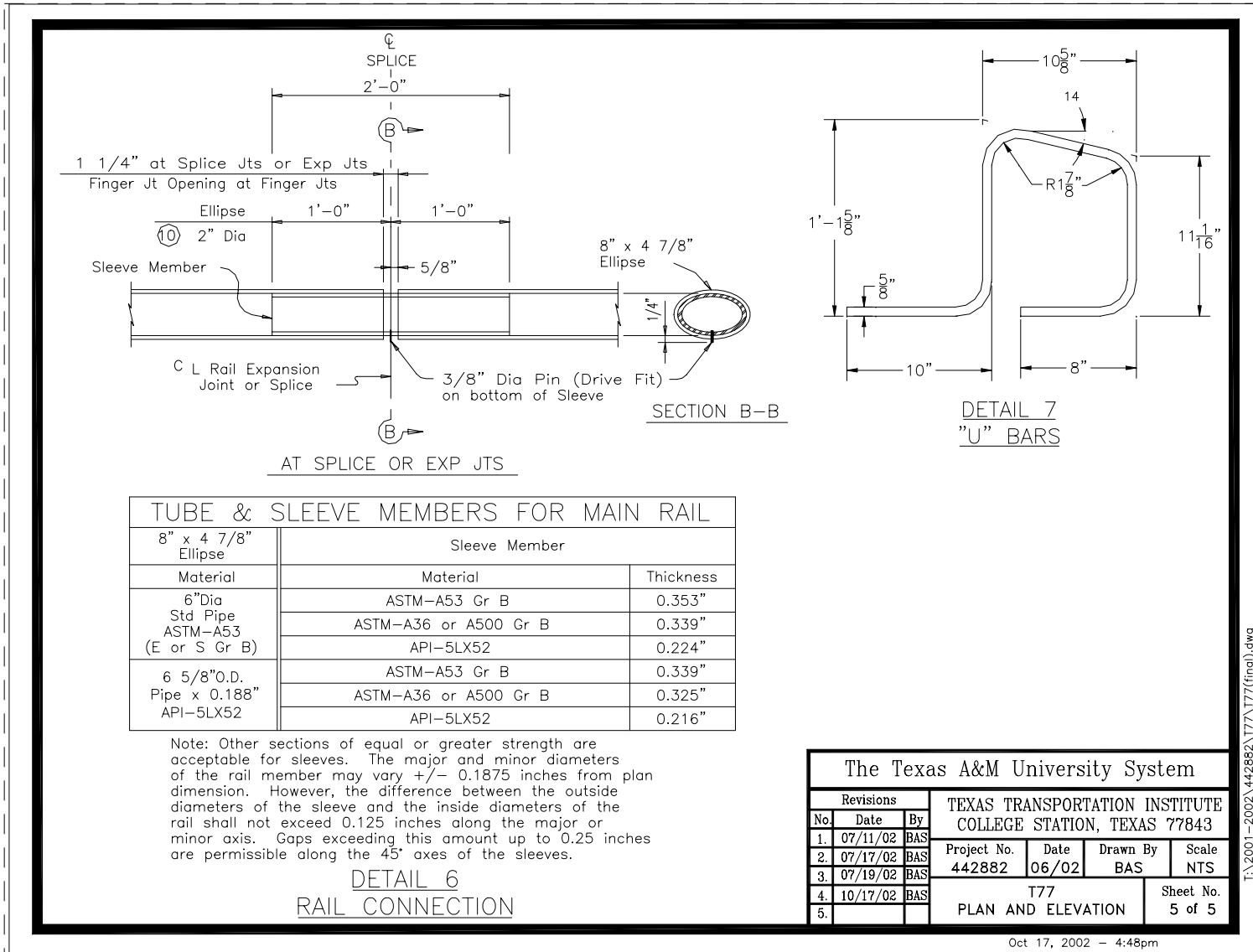


Figure 4. Details of the TxDOT T77 Bridge Rail (Continued).



Figure 5. TxDOT F411 Bridge Rail before Test 442882-3 and 4.

CRASH TEST CONDITIONS

According to *NCHRP Report 350*, two crash tests are recommended for test level 3 evaluation of length of need longitudinal barriers:

NCHRP Report 350 Test Designation 3-10: 820C vehicle impacting the length of need section at a speed of 100 km/h at an impact angle of 20 degrees.

NCHRP Report 350 Test Designation 3-11: 2000P vehicle impacting the length of need section at a speed of 100 km/h at an impact angle of 25 degrees.

The small car test is performed for evaluating the overall performance characteristics of the length of need section of a longitudinal barrier in general, and occupant risks in particular. The pickup truck test is performed for the purpose of evaluating the strength of the section in containing and redirecting the larger and heavier vehicle. Occupant risks are of foremost concern in the evaluation of both tests. Tests 442882-1 through 3 all correspond to *NCHRP Report 350* test designation 3-11. Test 442882-4 corresponds to *NCHRP Report 350* test designation 3-10.

Researchers conducted the crash test and data analysis procedures in accordance with guidelines presented in *NCHRP Report 350*. [Appendix C](#) presents brief descriptions of these procedures.

EVALUATION CRITERIA

The crash tests performed were evaluated in accordance with *NCHRP Report 350*. As stated in *NCHRP Report 350*, “Safety performance of a highway appurtenance cannot be measured directly but can be judged on the basis of three factors: structural adequacy, occupant risk, and vehicle trajectory after collision.” Accordingly, researchers used the safety evaluation criteria from Table 5.1 of *NCHRP Report 350* to evaluate the crash tests reported herein.

CHAPTER 3. CRASH TEST RESULTS

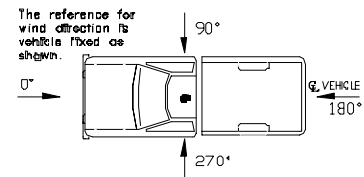
TEST NO. 442882-1 (NCHRP Report 350 TEST NO. 3-11) ON THE TXDOT F411 BRIDGE RAIL

Test Vehicle

A 1997 Chevrolet Cheyenne 2500 pickup truck, shown in Figures 6 and 7, was used for the crash test. Test inertia mass of the vehicle was 4502 lb (2044 kg), and its gross static mass was 4502 lb (2044 kg). The height to the lower edge of the vehicle bumper was 18.1 inches (460 mm), and it was 26.8 inches (680 mm) to the upper edge of the bumper. Additional dimensions and information on the vehicle are given in Appendix D, Figure 34. The vehicle was directed into the installation using the cable reverse tow and guidance system, and was released to be free-wheeling and unrestrained just prior to impact.

Weather Conditions

Researchers performed the test on the morning of May 6, 2002. Weather conditions at the time of testing were as follows: Wind speed: 11 mi/h (18 km/h); Wind direction: 335 degrees with respect to the vehicle (vehicle was traveling in a southwesterly direction); Temperature: 81°F (27 °C); Relative humidity: 69 percent.



Test Description

The vehicle, traveling at a speed of 61.4 mi/h (98.8 km/h), impacted the TxDOT F411 at an impact angle of 24.8 degrees at 5.1 inches (130 mm) upstream of opening 17. Shortly after impact, the vehicle hood deformed and at 0.018 s after impact, the vehicle began to redirect. The door on the passenger side separated slightly from the cab at 0.031 s and at 0.108 s, the left front tire became airborne. At 0.233 s, the vehicle became parallel with the bridge rail and was traveling at a speed of 42.1 mi/h (67.7 km/h). The left front tire returned to the ground at 0.304 s. At 0.386 s, the vehicle lost contact with the bridge rail and was traveling at a speed of 36.0 mi/h (57.9 km/h) and an exit angle of 7.3 degrees. Brakes on the vehicle were applied at 1.45 s after impact, and the vehicle subsequently came to rest 157.5 ft (48.0 m) downstream of impact and 7.5 ft (2.3 m) behind the traffic face of the rail. Sequential photographs of the test period are shown in Appendix E, Figures 38 and 39.



Figure 6. Vehicle/Bridge Rail Geometrics for Test 442882-1.



Figure 7. Vehicle before Test 442882-1.

Damage to Test Installation

The TxDOT F411 bridge rail sustained minimal cosmetic damage as shown in Figures 8 and 9. There were tire marks and scrapes along the face of the bridge rail for a distance of 11.4 ft (3.5 m). No cracks were noted in the beam rail, window frames, or deck. No measurable deformation occurred, and the working width was 1.4 ft. (0.4 m).

Vehicle Damage

Figure 10 shows damage imparted to the vehicle. Structural damage included deformation of the right upper and lower A-arms, right spindle and tie rod ends, stabilizer bar, right front of the frame, A and B pillars, floor pan, and firewall. Also damaged were the front bumper, hood, radiator and fan, right front tire and wheel, right front quarter panel, right door and window glass, and right side bed. The roof was deformed and the windshield was cracked. Maximum exterior crush to the vehicle was 25.6 inches (650 mm) in the front plane at the right front corner near bumper height. The vehicle was also crushed 20.9 inches (530 mm) in the side plane at the right front corner near bumper height. Maximum occupant compartment deformation was 8.3 inches (210 mm) in the right side door area. The right side floor pan area was deformed inward 7.3 inches (186 mm), and the right side firewall area was deformed inward 6.9 inches (175 mm). Figure 11 shows photographs of the interior of the vehicle. Exterior vehicle crush and occupant compartment deformation are shown in Appendix D, Tables 5 and 6.

Occupant Risk Factors

Data from the tri-axial accelerometer, located at the vehicle center of gravity, were digitized to compute occupant impact velocity and ridedown accelerations. Only the occupant impact velocity and ridedown accelerations in the longitudinal axis are required from these data for evaluation of criterion L of *NCHRP Report 350*. In the longitudinal direction, occupant impact velocity was 26.2 ft/s (8.0 m/s) at 0.100 s, maximum 0.010-s ridedown acceleration was -6.0 g's from 0.100 to 0.110 s, and the maximum 0.050-s average was -12.3 g's between 0.062 and 0.112 s. Figure 12 presents these data and other information pertinent to the test. Vehicle angular displacements and accelerations versus time traces are shown in Appendix F, Figures 46 and 50 through 55, respectively.

Assessment of Test Results

An assessment of the test based on the applicable *NCHRP Report 350* safety evaluation criteria is provided below.

◆ Structural Adequacy

- A. *Test article should contain and redirect the vehicle; the vehicle should not penetrate, underride, or override the installation although controlled lateral deflection of the test article is acceptable.*



Figure 8. After Impact Trajectory for Test 442882-1.



Figure 9. Installation after Test 442882-1.



Figure 10. Vehicle after Test 442882-1.

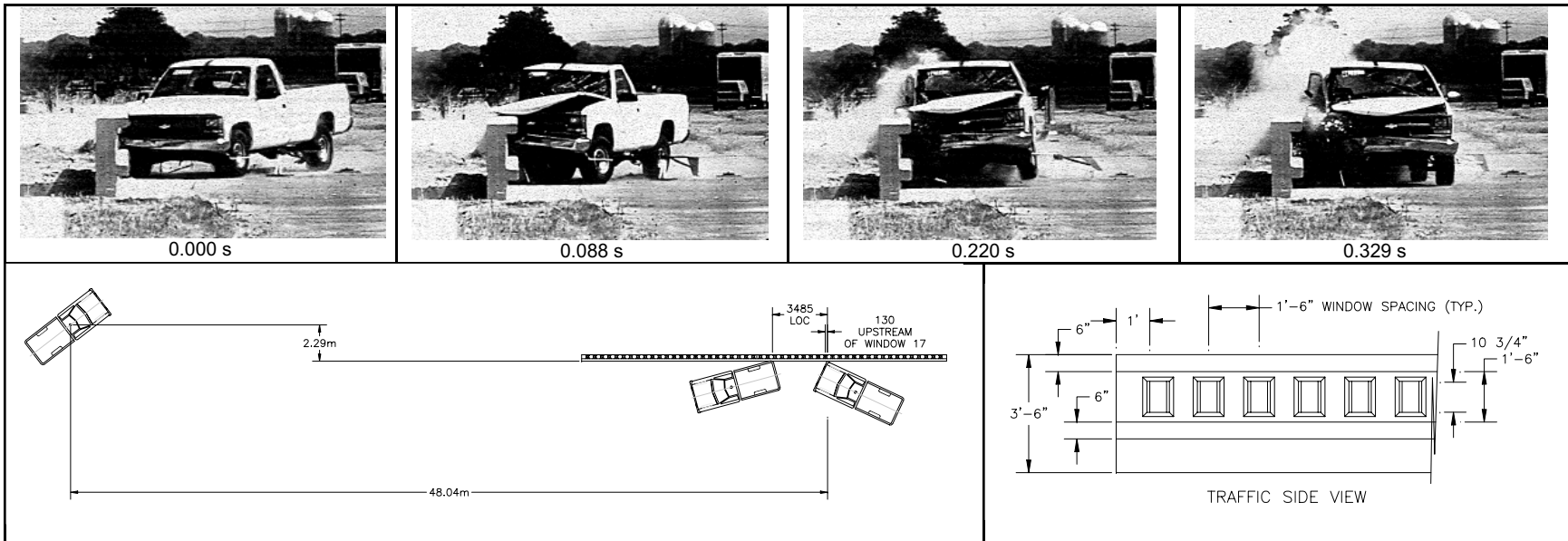


Before Test



After Test

Figure 11. Interior of Vehicle for Test 442882-1.



General Information

Test Agency Texas Transportation Institute
 Test No. 442882-1
 Date 05/06/02

Test Article

Type Bridge Rail
 Name F411 Aesthetic Bridge Rail
 Installation Length (ft) 76 (23.2 m)
 Material or Key Elements Concrete Bridge Rail With Two Concrete Rails And Aesthetic Openings
 Soil Type and Condition Concrete Footing, Dry

Test Vehicle

Type Production
 Designation 2000P
 Model 1997 Chevrolet 2500 Pickup
 Mass (lbs)
 Curb 4778 (2170 kg)
 Test Inertial 4502 (2044 kg)
 Dummy N/A
 Gross Static 4502 (2044 kg)

Impact Conditions

Speed (mi/h) 61.4 (98.8 km/h)
 Angle (deg) 24.8

Exit Conditions

Speed (mi/h) 36.0 (57.9 km/h)
 Angle (deg) 7.3

Occupant Risk Values

Impact Velocity (ft/s)
 x-direction 26.2 (8.0 m/s)
 y-direction 23.0 (7.0 m/s)
 THIV (mph) 23.5 (37.8 km/h)
 Ridedown Accelerations (g's)
 x-direction -6.0
 y-direction -5.4
 PHD (g's) 6.8
 ASI 1.50
 Max. 0.050-s Average (g's)
 x-direction -12.3
 y-direction -10.5
 z-direction 5.2

Test Article Deflections (ft)

Dynamic None
 Permanent None
 Working Width 1.41 (0.43 m)

Vehicle Damage

Exterior
 VDS 01FR2
 CDC 01RFAW3
 Maximum Exterior
 Vehicle Crush (in) 25.6 (650 mm)
 Interior
 OCDI RF2222010
 Max. Occ. Compart.
 Deformation (in) 8.3 (210 mm)

Post-Impact Behavior

(during 1.0 s after impact)
 Max. Yaw Angle (deg) -30.5
 Max. Pitch Angle (deg) -2.2
 Max. Roll Angle (deg) 4.1

Figure 12. Summary of Results for Test 442882-1, NCHRP Report 350 Test 3-11.

Results: The TxDOT F411 bridge rail contained and redirected the pickup truck. No measurable deflection occurred.

◆ **Occupant Risk**

D. Detached elements, fragments, or other debris from the test article should not penetrate or show potential for penetrating the occupant compartment, or present an undue hazard to other traffic, pedestrians, or personnel in a work zone. Deformation of, or intrusions into, the occupant compartment that could cause serious injuries should not be permitted.

Results: No detached elements, fragments, or other debris were present to penetrate or to show potential for penetrating the occupant compartment, or to present undue hazard to others in the area. However, maximum deformation of the occupant compartment was 8.3 inches (210 mm) in the door area, 7.3 inches (186 mm) in the right floor pan area, and 6.9 inches (175 mm) in the right firewall area.

F. The vehicle should remain upright during and after collision although moderate roll, pitching, and yawing are acceptable.

Results: The pickup truck remained upright during and after the collision period.

◆ **Vehicle Trajectory**

K. After collision, it is preferable that the vehicle's trajectory not intrude into adjacent traffic lanes.

Results: The pickup truck came to rest 157.5 ft (48.0 m) downstream of impact and 7.5 ft (2.3 m) behind the traffic face of the bridge rail.

L. The occupant impact velocity in the longitudinal direction should not exceed 12 m/s, and the occupant ridedown acceleration in the longitudinal direction should not exceed 20 g's.

Results: Longitudinal occupant impact velocity was 26.2 ft/s (8.0 m/s), and longitudinal ridedown acceleration was -6.0 g's.

M. The exit angle from the test article preferably should be less than 60 percent of the test impact angle, measured at time of vehicle loss of contact with the test device.

Results: Exit angle at loss of contact with the bridge rail was 7.3 degrees, which is 29 percent of the impact angle.

The following supplemental evaluation factors and terminology, as presented in the FHWA memo entitled “Action: Identifying Acceptable Highway Safety Features,” were used for visual assessment of test results:

◆ **Passenger Compartment Intrusion**

- | | |
|--|--|
| 1. Windshield Intrusion | |
| a. <u>No windshield contact</u> | e. Complete intrusion into passenger compartment |
| b. Windshield contact, no damage | |
| c. Windshield contact, no intrusion | f. Partial intrusion into passenger compartment |
| d. Device embedded in windshield, no significant intrusion | |
| 2. Body Panel Intrusion | <u>yes</u> or no |

◆ **Loss of Vehicle Control**

- | | |
|------------------------------------|---------------------------------------|
| 1. <u>Physical loss of control</u> | 3. Perceived threat to other vehicles |
| 2. Loss of windshield visibility | 4. Debris on pavement |

◆ **Physical Threat to Workers or Other Vehicles**

1. Harmful debris that could injure workers or others in the area
 2. Harmful debris that could injure occupants in other vehicles
- No debris was present.

◆ **Vehicle and Device Condition**

- | | |
|---|---|
| 1. Vehicle Damage | |
| a. None | d. Major dents to grill and body panels |
| b. Minor scrapes, scratches or dents | e. <u>Major structural damage</u> |
| c. Significant cosmetic dents | |
| 2. Windshield Damage | |
| a. None | e. Shattered, remained intact but partially dislodged |
| b. Minor chip or crack | f. Large portion removed |
| c. <u>Broken, no interference with visibility</u> | g. Completely removed |
| d. Broken or shattered, visibility restricted but remained intact | |
| 3. Device Damage | |
| a. None | d. Substantial, replacement parts needed for repair |
| b. <u>Superficial</u> | e. Cannot be repaired |
| c. Substantial, but can be straightened | |

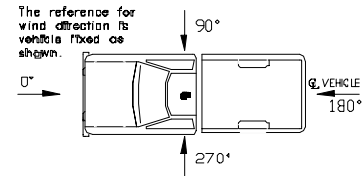
TEST NO. 442882-2 (NCHRP Report 350 TEST NO. 3-11) ON THE MODIFIED TXDOT F411 BRIDGE RAIL

Test Vehicle

A 1998 Chevrolet 2500 pickup truck, shown in Figures 13 and 14, was used for the crash test. Test inertia mass of the vehicle was 4518 lb (2052 kg), and its gross static mass was 4518 lb (2052 kg). The height to the lower edge of the vehicle bumper was 14.0 inches (360 mm), and it was 25.2 inches (645 mm) to the upper edge of the bumper. Additional dimensions and information on the vehicle are given in Appendix D, Figure 35. The vehicle was directed into the installation using the cable reverse tow and guidance system, and was released to be free-wheeling and unrestrained just prior to impact.

Weather Conditions

Researchers performed the test on the morning of July 18, 2002. Weather conditions at the time of testing were as follows: Wind speed: 3 mi/h (5 km/h); Wind direction: 0 degrees with respect to the vehicle (vehicle was traveling in a southwesterly direction); Temperature: 88 °F (31°C); Relative humidity: 64 percent.



Test Description

The vehicle, traveling at a speed of 62.8 mi/h (101.1 km/h), impacted the modified TxDOT F411 at an impact angle of 26.1 degrees at 2.3 inches (58 mm) downstream of opening 17. Shortly after impact, the hood began to open and the top of the door on the driver's side separated slightly from the door frame and at 0.033 s, the vehicle began to redirect. The right front tire became airborne at 0.079 s. At 0.202 s, the vehicle became parallel with the bridge rail and was traveling at a speed of 52.8 mi/h (84.9 km/h). At 0.287 s, the vehicle lost contact with the bridge rail and was traveling at a speed of 49.6 mi/h (79.9 km/h) and an exit angle of 4.5 degrees. The right front tire returned to the ground at 0.332 s. Brakes on the vehicle were applied at 1.5 s after impact, and the vehicle subsequently came to rest 221.4 ft (67.5 m) downstream of impact and 15.6 ft (4.8 m) forward of the traffic face of the rail. Sequential photographs of the test period are shown in Appendix E, Figures 40 and 41.

Damage to Test Installation

The modified TxDOT F411 bridge rail sustained minimal cosmetic damage as shown in Figures 15 and 16. There were tire marks and scrapes along the face of the lower beam of the bridge rail for a distance of 9.8 ft (3.0 m). No cracks were noted in the beam rail, window frames, or deck. No measurable deformation occurred, and the working width was 1.7 ft (0.5 m).



Figure 13. Vehicle/Bridge Rail Geometrics for Test 442882-2.



Figure 14. Vehicle before Test 442882-2.

Vehicle Damage

Figure 17 shows damage imparted to the vehicle. Structural damage included deformation of the left upper and lower A-arms, left rod ends, sway bar, left A- and B-pillars, floor pan, and firewall. Also damaged were the front bumper, grill, hood, radiator and fan, left front tire and wheel, left front quarter panel, left door, and left side bed. The roof was deformed, and the windshield was cracked. Maximum exterior crush to the vehicle was 26.4 inches (670 mm) in the side plane at the left front corner 31.9 inches (810 mm) above ground level. The vehicle was also crushed 21.7 inches (550 mm) in the frontal plane at the left corner near bumper height. Maximum occupant compartment deformation was 4.6 inches (118 mm) in the instrument panel area. The factory-installed opening, which accommodates the manual transmission floor shift, tore at the forward and rear corners, increasing the opening to 7.1 inches (180 mm) long and 6.3 inches (160 mm) wide. (The dimensions of the factory-installed opening for the floor shift was originally 5.6 inches [143 mm] by 5.6 inches [143 mm]). No other separation in the floor pan or toe pan was noted. Figure 18 shows photographs of the interior of the vehicle. Exterior vehicle crush and occupant compartment deformations are shown in Appendix D, Tables 7 and 8.

Occupant Risk Factors

Data from the tri-axial accelerometer, located at the vehicle center of gravity, were digitized to compute occupant impact velocity and ridedown accelerations. Only the occupant impact velocity and ridedown accelerations in the longitudinal axis are required from these data for evaluation of criterion L of *NCHRP Report 350*. In the longitudinal direction, occupant impact velocity was 24.6 ft/s (7.5 m/s) at 0.095 s, maximum 0.010-s ridedown acceleration was -6.7 g's from 0.110 to 0.120 s, and the maximum 0.050-s average was -10.7 g's between 0.041 and 0.091 s. These data and other information pertinent to the test are presented in Figure 19. Vehicle angular displacements and accelerations versus time traces are shown in Appendix F, Figures 47 and 56 through 61, respectively.

Assessment of Test Results

An assessment of the test based on the applicable *NCHRP Report 350* safety evaluation criteria is provided below.

◆ Structural Adequacy

- A. *Test article should contain and redirect the vehicle; the vehicle should not penetrate, underride, or override the installation although controlled lateral deflection of the test article is acceptable.*

Results: The modified TxDOT F411 bridge rail contained and redirected the pickup truck. No measurable deflection occurred.



Figure 15. After Impact Trajectory for Test 442882-2.



Figure 16. Installation after Test 442882-2.



Figure 17. Vehicle after Test 442882-2.



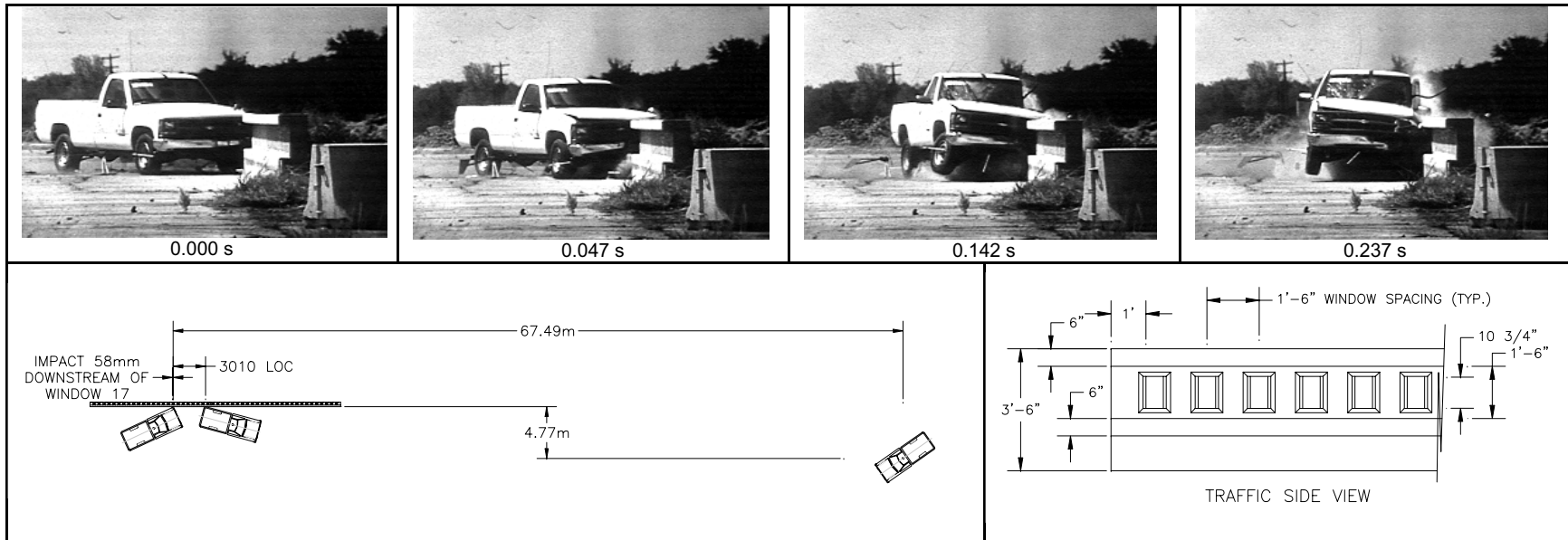
Before Test



After Test



Figure 18. Interior of Vehicle for Test 442882-2.



39

General Information		Impact Conditions		Test Article Deflections (ft)	
Test Agency	Texas Transportation Institute	Speed (mi/h)	62.8 (101.1 km/h)	Dynamic	None
Test No.	442882-2	Angle (deg)	26.1	Permanent	None
Date	07/18/02	Exit Conditions		Working Width	1.71 (0.52 m)
Test Article		Speed (mi/h)	49.6 (79.9 km/h)	Vehicle Damage	
Type	Bridge Rail	Angle (deg)	4.5	Exterior	
Name	F411 Aesthetic Bridge Rail	Occupant Risk Values		VDS	11FL3
Installation Length (ft)	76 (23.2 m)	Impact Velocity (ft/s)		CDC	11LFAW3
Material or Key Elements	Concrete Bridge Rail With Two Concrete Rails And Aesthetic Openings	x-direction	24.6 (7.5 m/s)	Maximum Exterior	
Soil Type and Condition	Concrete Footing	y-direction	28.5 (8.7 m/s)	Vehicle Crush (in)	26.4 (670 mm)
Test Vehicle		THIV (mph)	25.5 (41.0 km/h)	Interior	
Type	Production	Ridedown Accelerations (g's)		OCDI	LF2010000
Designation	2000P	x-direction	-6.7	Max. Occ. Compart.	
Model	1998 Chevrolet 2500 Pickup	y-direction	8.0	Deformation (in)	4.6 (118 mm)
Mass (lbs)		PHD (g's)	8.6	Post-Impact Behavior	
Curb	4569 (2075 kg)	ASI	1.76	(during 1.0 s after impact)	
Test Inertial	4518 (2052 kg)	Max. 0.050-s Average (g's)		Max. Yaw Angle (deg)	33.5
Dummy	N/A	x-direction	-10.7	Max. Pitch Angle (deg)	-2.9
Gross Static	4518 (2052 kg)	y-direction	13.8	Max. Roll Angle (deg)	-7.6
		z-direction	4.3		

Figure 19. Summary of Results for Test 442882-2, NCHRP Report 350 Test 3-11.

◆ **Occupant Risk**

- D. *Detached elements, fragments, or other debris from the test article should not penetrate or show potential for penetrating the occupant compartment, or present an undue hazard to other traffic, pedestrians, or personnel in a work zone. Deformation of, or intrusions into, the occupant compartment that could cause serious injuries should not be permitted.*

Results: No detached elements, fragments, or other debris were present to penetrate or to show potential for penetrating the occupant compartment, or to present undue hazard to others in the area. Deformation of the occupant compartment was 4.6 inches (118 mm) in the instrument panel area and 4.1 inches (105 mm) in the firewall area. The factory-installed opening, which accommodates the manual transmission floor shift, tore at the forward and rear corners, increasing the opening to 7.1 inches (180 mm) long and 6.3 inches (160 mm) wide. (The dimensions of the factory-installed opening for the floor shift was originally 5.6 inches [143 mm] by 5.6 inches [143 mm]). No other separation in the floor pan or toe pan was noted.

- F. *The vehicle should remain upright during and after collision although moderate roll, pitching, and yawing are acceptable.*

Results: The pickup truck remained upright during and after the collision period.

◆ **Vehicle Trajectory**

- K. *After collision, it is preferable that the vehicle's trajectory not intrude into adjacent traffic lanes.*

Results: The pickup truck came to rest 221.4 ft (67.5 m) downstream of impact and 15.6 ft (4.8 m) forward of the traffic face of the bridge rail.

- L. *The occupant impact velocity in the longitudinal direction should not exceed 12 m/s and the occupant ridedown acceleration in the longitudinal direction should not exceed 20 g's.*

Results: Longitudinal occupant impact velocity was 24.6 ft/s (7.5 m/s), and longitudinal ridedown acceleration was -6.7 g's.

- M. *The exit angle from the test article preferably should be less than 60 percent of the test impact angle, measured at time of vehicle loss of contact with the test device.*

Results: Exit angle at loss of contact with the bridge rail was 4.5 degrees, which is 17 percent of the impact angle.

The following supplemental evaluation factors and terminology, as presented in the FHWA memo entitled “Action: Identifying Acceptable Highway Safety Features,” were used for visual assessment of test results:

◆ **Passenger Compartment Intrusion**

- | | |
|--|--|
| 1. Windshield Intrusion | |
| a. <u>No windshield contact</u> | e. Complete intrusion into passenger compartment |
| b. Windshield contact, no damage | f. Partial intrusion into passenger compartment |
| c. Windshield contact, no intrusion | |
| d. Device embedded in windshield, no significant intrusion | |
| 2. Body Panel Intrusion | <u>yes</u> or no |

◆ **Loss of Vehicle Control**

- | | |
|------------------------------------|---------------------------------------|
| 1. <u>Physical loss of control</u> | 3. Perceived threat to other vehicles |
| 2. Loss of windshield visibility | 4. Debris on pavement |

◆ **Physical Threat to Workers or Other Vehicles**

1. Harmful debris that could injure workers or others in the area
2. Harmful debris that could injure occupants in other vehicles
No debris was present.

◆ **Vehicle and Device Condition**

- | | |
|---|---|
| 1. Vehicle Damage | |
| a. None | d. Major dents to grill and body panels |
| b. Minor scrapes, scratches or dents | e. <u>Major structural damage</u> |
| c. Significant cosmetic dents | |
| 2. Windshield Damage | |
| a. None | e. Shattered, remained intact but partially dislodged |
| b. Minor chip or crack | f. Large portion removed |
| c. <u>Broken, no interference with visibility</u> | g. Completely removed |
| d. Broken or shattered, visibility restricted but remained intact | |
| 3. Device Damage | |
| a. None | d. Substantial, replacement parts needed for repair |
| b. <u>Superficial</u> | e. Cannot be repaired |
| c. Substantial, but can be straightened | |

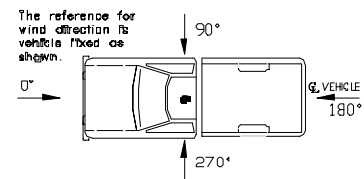
TEST NO. 442882-3 (NCHRP Report 350 TEST NO. 3-11) ON THE TXDOT T77 BRIDGE RAIL

Test Vehicle

A 1997 Chevrolet 2500 pickup truck, shown in Figures 20 and 21, was used for the crash test. Test inertia mass of the vehicle was 4500 lb (2043 kg), and its gross static mass was 4500 lb (2043 kg). The height to the lower edge of the vehicle bumper was 14.4 inches (365 mm), and it was 25.6 inches (650 mm) to the upper edge of the bumper. Additional dimensions and information on the vehicle are given in Appendix D, Figure 36. The vehicle was directed into the installation using the cable reverse tow and guidance system, and was released to be free-wheeling and unrestrained just prior to impact.

Weather Conditions

Researchers performed the test on the morning of August 23, 2002. Weather conditions at the time of testing were as follows: Wind speed: 6 mi/h (9 km/h); Wind direction: 320 degrees with respect to the vehicle (vehicle was traveling in a southwesterly direction); Temperature: 90 °F (32 °C); Relative humidity: 63 percent.



Test Description

The pickup truck, traveling at a speed of 60.8 mi/h (97.8 km/h), impacted the TxDOT T77 bridge rail at an impact angle of 24.2 degrees at 3.9 ft (1.2 m) upstream of post 4. At approximately 0.017 s after impact, the hood of the vehicle snapped loose. At 0.029 s post 4 began to deflect toward the field side. The right front corner of the vehicle bumper pushed between the rail elements and contacted post 4 at 0.037 s. Post 3 began to deflect toward the field side at 0.039 s. At 0.041 s the pickup began to redirect, and at 0.057 s the passenger door deformed at the top of the door frame. At 0.069 s post 5 began to deflect toward the field side. The pickup began traveling parallel with the bridge rail at 0.224 s and was traveling at a speed of 47.7 mi/h (76.8 km/h). At 0.226 s the rail element between posts 3 and 4 began to deform. By 0.427 s, the pickup lost contact with the rail element and was traveling at an exit speed of 44.7 mi/h (71.9 km/h) and an exit angle of 10.8 degrees. Brakes on the vehicle were applied at 1.45 s after impact. The vehicle contacted a secondary barrier, yawed clockwise, and came to rest 187.7 ft (57.2 m) downstream of impact and 12.5 ft (3.8 m) forward of the traffic face of the rail. Sequential photographs of the test period are shown in Appendix E, Figures 42 and 43.

Damage to Test Installation

Damage to the TxDOT T77 bridge rail is shown in Figures 22 and 23. The concrete curb was broken out around post 4, and the post and rail were deflected toward the rear side 0.4 inches



Figure 20. Vehicle/Bridge Rail Geometrics for Test 442882-3.



Figure 21. Vehicle before Test 442882-3.

(10 mm). The pickup snagged on the lower rail splice just upstream of post 4 and expanded the joint 0.1 inch (3 mm). The lower rail element was also crushed 1.0 inch (25 mm). The pickup was in contact with the rail for 16.4 ft (5.0 m). Maximum deflection of the rail during the test was 1.8 inches (47 mm), and maximum permanent deformation was 0.4 inch (10 mm). Working width was 2.1 ft (0.6 m).

Vehicle Damage

The vehicle sustained damage as shown in [Figure 24](#). The right side A-arms, sway bar, and right front of the frame rail were deformed. The A-pillar was deformed, there was a crease in the top right side of the cab, and the top of the right door was pulled away from the cab 11.4 inches (290 mm). Also damaged were the front bumper, hood, grill, radiator, fan, right front and left front quarter panel, right side bed, rear bumper, and right rear tire and wheel. The right front tire and exterior part of the wheel rim separated from the center part of the wheel rim (at the pop rivets). Small pieces of sheet metal were torn from the lower section of the cab and the right rear side of the bed (2.4 inches × 5.9 inches [60 mm × 150 mm]). Maximum exterior crush to the vehicle was 30.7 inches (780 mm) in the front plane at the right front corner at bumper height. Maximum occupant compartment deformation was 8.7 inches (222 mm) in the right front firewall. Photographs of the interior of the vehicle are shown in [Figure 25](#). Exterior vehicle crush and occupant compartment deformations are shown in [Appendix D](#), Tables 9 and 10.

Occupant Risk Factors

Data from the tri-axial accelerometer, located at the vehicle center of gravity, were digitized to compute occupant impact velocity and ridedown accelerations. Only the occupant impact velocity and ridedown accelerations in the longitudinal axis are required from these data for evaluation of criterion L of *NCHRP Report 350*. In the longitudinal direction, occupant impact velocity was 21.6 ft/s (6.6 m/s) at 0.111 s, maximum 0.010-s ridedown acceleration was -5.6 g's from 0.111 to 0.121 s, and the maximum 0.050-s average was -9.8 g's between 0.027 and 0.077 s. These data and other information pertinent to the test are presented in [Figure 26](#). Vehicle angular displacements and accelerations versus time traces are shown in [Appendix F](#), Figures 48 and 62 through 67, respectively.

Assessment of Test Results

An assessment of the test based on the applicable *NCHRP Report 350* safety evaluation criteria is provided below.

◆ Structural Adequacy

A. Test article should contain and redirect the vehicle; the vehicle should not penetrate, underride, or override the installation although controlled lateral deflection of the test article is acceptable.



Figure 22. After Impact Trajectory for Test 442882-3.



Figure 23. Installation after Test 442882-3.



Figure 24. Vehicle after Test 442882-3.



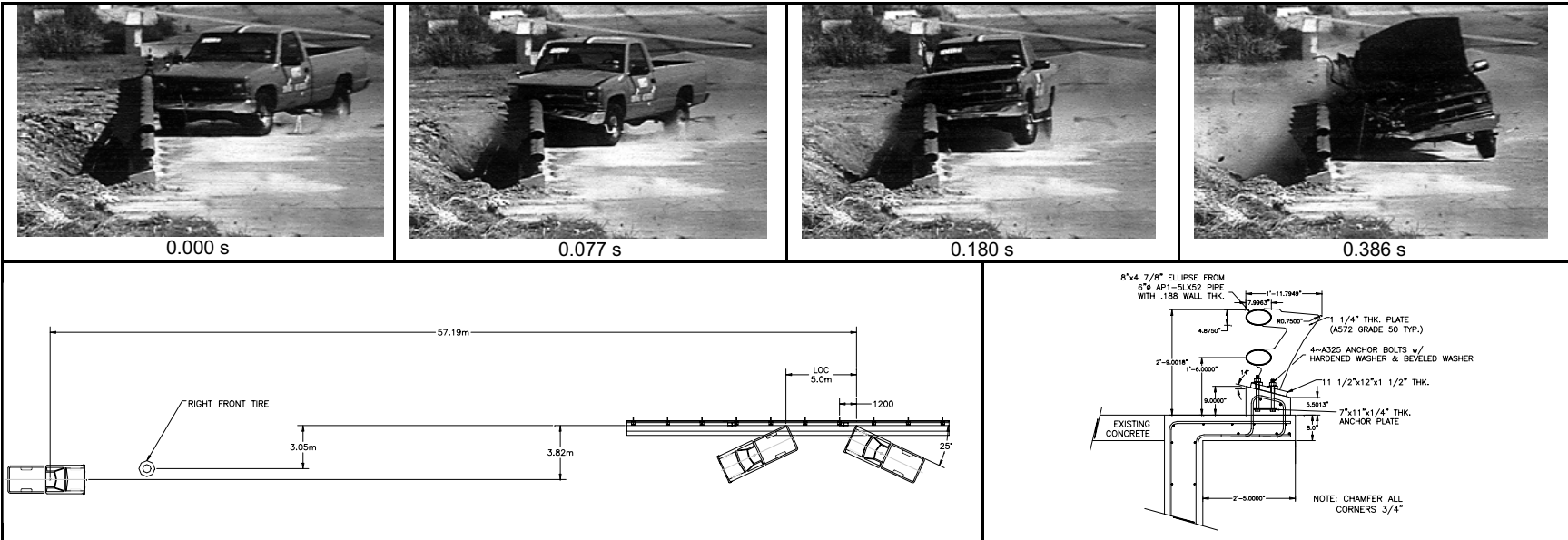
Before Test



After Test



Figure 25. Interior of Vehicle for Test 442882-3.



General Information		Impact Conditions		Test Article Deflections (ft)	
Test Agency	Texas Transportation Institute	Speed (mi/h)	60.8 (97.8 km/h)	Dynamic	0.18 (0.05 m)
Test No.	442882-3	Angle (deg)	24.2	Permanent	0.04 (0.01 m)
Date	08/23/02	Exit Conditions		Working Width	2.10 (0.64 m)
Test Article		Speed (mi/h)	44.7 (71.9 km/h)	Vehicle Damage	
Type	Bridge Rail	Angle (deg)	10.8	Exterior	
Name	T77 Aesthetic Bridge Rail	Occupant Risk Values		VDS	
Installation Length (ft)	75 (22.7 m)	Impact Velocity (ft/s)		CDC	
Material or Key Elements	Tubular Steel Rail Elements Mounted On Steel "7" Shaped Posts	x-direction	21.6 (6.6 m/s)	Maximum Exterior	
Soil Type and Condition	Concrete Footing	y-direction	21.0 (6.4 m/s)	Vehicle Crush (in)	
Test Vehicle		THIV (mph)	19.9 (32.1 km/h)	Interior	
Type	Production	Ridedown Accelerations (g's)		OCDI	
Designation	2000P	x-direction	-5.6	Max. Occ. Comp.	
Model	1997 Chevrolet 2500 Pickup	y-direction	-13.5	Deformation (in)	
Mass (lbs)		PHD (g's)	14.2	Post-Impact Behavior	
Curb	4723 (2145 kg)	ASI	1.23	(during 1.0 s after impact)	
Test Inertial	4500 (2043 kg)	Max. 0.050-s Average (g's)		Max. Yaw Angle (deg)	
Dummy	N/A	x-direction	-9.8	Max. Pitch Angle (deg)	
Gross Static	4500 (2043 kg)	y-direction	-9.4	Max. Roll Angle (deg)	
		z-direction	-4.7		

Figure 26. Summary of Results for Test 442882-3, NCHRP Report 350 Test 3-11.

Results: The TxDOT T77 bridge rail contained and redirected the pickup truck. The vehicle did not penetrate, underride, or override the bridge rail. Maximum dynamic deflection of the rail was 1.9 inches (47 mm).

◆ **Occupant Risk**

D. *Detached elements, fragments, or other debris from the test article should not penetrate or show potential for penetrating the occupant compartment, or present an undue hazard to other traffic, pedestrians, or personnel in a work zone. Deformation of, or intrusions into, the occupant compartment that could cause serious injuries should not be permitted.*

Results: No detached elements, fragments, or other debris were present to penetrate or to show potential for penetrating the occupant compartment, or to present undue hazard to others in the area. Maximum occupant compartment deformation was 8.7 inches (222 mm).

F. *The vehicle should remain upright during and after collision although moderate roll, pitching, and yawing are acceptable.*

Results: The pickup truck remained upright during and after the collision event.

◆ **Vehicle Trajectory**

K. *After collision, it is preferable that the vehicle's trajectory not intrude into adjacent traffic lanes.*

Results: The vehicle came to rest 187.6 ft (57.2 m) downstream of impact and 12.5 ft (3.8 m) forward of the face of the rail.

L. *The occupant impact velocity in the longitudinal direction should not exceed 12 m/s and the occupant ridedown acceleration in the longitudinal direction should not exceed 20 g's.*

Results: Longitudinal occupant impact velocity was 21.6 ft/s (6.6 m/s) and longitudinal ridedown acceleration was -5.6 g's.

M. *The exit angle from the test article preferably should be less than 60 percent of the test impact angle, measured at time of vehicle loss of contact with the test device.*

Results: Exit angle at loss of contact with the bridge rail was 10.8 degrees, which is 44 percent of the impact angle.

The following supplemental evaluation factors and terminology, as presented in the FHWA memo entitled “Action: Identifying Acceptable Highway Safety Features,” were used for visual assessment of test results:

◆ **Passenger Compartment Intrusion**

- | | |
|--|--|
| 1. Windshield Intrusion | |
| a. <u>No windshield contact</u> | e. Complete intrusion into passenger compartment |
| b. Windshield contact, no damage | f. Partial intrusion into passenger compartment |
| c. Windshield contact, no intrusion | |
| d. Device embedded in windshield, no significant intrusion | |
| 2. Body Panel Intrusion | <u>yes</u> or no |

◆ **Loss of Vehicle Control**

- | | |
|------------------------------------|---------------------------------------|
| 1. <u>Physical loss of control</u> | 3. Perceived threat to other vehicles |
| 2. Loss of windshield visibility | 4. Debris on pavement |

◆ **Physical Threat to Workers or Other Vehicles**

1. Harmful debris that could injure workers or others in the area
 2. Harmful debris that could injure occupants in other vehicles
- No debris was present.

◆ **Vehicle and Device Condition**

- | | |
|---|--|
| 1. Vehicle Damage | |
| a. None | d. Major dents to grill and body panels |
| b. Minor scrapes, scratches or dents | e. <u>Major structural damage</u> |
| c. Significant cosmetic dents | |
| 2. Windshield Damage | |
| a. None | e. Shattered, remained intact but partially dislodged |
| b. <u>Minor chip or crack (stress cracks)</u> | f. Large portion removed |
| c. Broken, no interference with visibility | g. Completely removed |
| d. Broken or shattered, visibility restricted but remained intact | |
| 3. Device Damage | |
| a. None | d. <u>Substantial, replacement parts needed for repair</u> |
| b. Superficial | e. Cannot be repaired |
| c. Substantial, but can be straightened | |

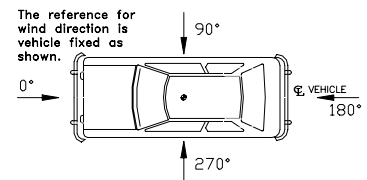
TEST NO. 442882-4 (NCHRP Report 350 TEST NO. 3-10) ON THE TXDOT T77 BRIDGE RAIL

Test Vehicle

A 1997 Geo Metro, shown in Figures 27 and 28, was used for the crash test. Test inertia mass of the vehicle was 1806 lb (820 kg), and its gross static mass was 1976 lb (897 kg). The height to the lower edge of the vehicle bumper was 15.7 inches (400 mm), and it was 20.7 inches (525 mm) to the upper edge of the bumper. Additional dimensions and information on the vehicle are given in Appendix D, Figure 37. The vehicle was directed into the installation using the cable reverse tow and guidance system, and was released to be free-wheeling and unrestrained just prior to impact.

Weather Conditions

Researchers performed the test on the morning of August 27, 2002. Weather conditions at the time of testing were as follows: Wind speed: 0 mi/h (0 km/h); Wind direction: 0 degrees with respect to the vehicle (vehicle was traveling in a southwesterly direction); Temperature: 88 °F (31 °C); Relative humidity: 69 percent.



Test Description

The small car, traveling at a speed of 61.6 mi/h (99.1 km/h), impacted the TxDOT T77 bridge rail 4.5 ft (1.4 m) upstream of post 7 at an impact angle of 20.4 degrees. At approximately 0.042 s after impact, the vehicle began to redirect, and at 0.070 s the driver side door glass shattered. The vehicle began traveling parallel with the rail at 0.132 s, and was traveling at a speed of 52.5 mi/h (84.5 km/h). At 0.304 s, the vehicle lost contact with the bridge rail and was traveling at a speed of 51.0 mi/h (82.0 km/h) and an exit angle of 12.1 degrees. Brakes on the vehicle were applied 1.7 s after impact. The vehicle subsequently came to rest 202.7 ft (61.8 m) downstream of impact and 87.6 ft (26.7 m) forward of the traffic face of the rail. Sequential photographs of the test period are shown in Appendix E, Figures 44 and 45.

Damage to Test Installation

The TxDOT T77 bridge rail sustained damage as shown in Figures 29 and 30. The edge of the concrete curb was chipped off in the area of initial contact. A hairline crack in the concrete curb radiated from the right rear bolt at post 7, and the post and rail were deflected toward the rear side 0.4 inches (10 mm). The small car snagged on the upper and lower rail splice just upstream of post 7. The small car was in contact with the rail 9.7 ft (3.0 m). There was no measurable deflection of the rail during the test, and maximum permanent deformation was 0.4 inches (10 mm). Working width was 1.9 ft (0.6 m).



Figure 27. Vehicle/Bridge Rail Geometrics for Test 442882-4.



Figure 28. Vehicle before Test 442882-4.

Vehicle Damage

Figure 31 shows damage imparted to the vehicle. The inner CV joint on the left side was pulled out of the transmission, the lower left ball joint separated, and the left front and rear struts were deformed. A piece of sheet metal was torn from the left front quarter panel and from the left door. The driver's side door was pushed outward, and the top of the door was separated from the door frame 2.6 inches (65 mm). The windshield sustained stress cracks and there was a small dent in the roof just above the A-pillar. Also damaged were the front bumper, hood, grill, radiator, fan, left front quarter panel, left front tire and wheel rim, left door and glass, left rear quarter panel, and left rear taillight. Maximum exterior crush to the vehicle was 8.9 inches (230 mm) in the frontal plane at the left front corner near bumper height. Maximum occupant compartment deformation was 1.0 inch (25 mm) in the left front firewall area and the left side kickpanel area. Photographs of the interior of the vehicle are shown in Figure 32. Exterior vehicle crush and occupant compartment deformations are shown in Appendix D, Tables 11 and 12.

Occupant Risk Factors

Data from the accelerometer, located at the vehicle center of gravity (c.g.), were digitized for evaluation of occupant risk and were computed as follows. In the longitudinal direction, the occupant impact velocity was 16.7 ft/s (5.1 m/s) at 0.082 s, the highest 0.010-s occupant ridedown acceleration was -2.3 g's from 0.171 to 0.181 s, and the maximum 0.050-s average acceleration was -9.8 g's between 0.026 and 0.076 s. In the lateral direction, the occupant impact velocity was 25.6 ft/s (7.8 m/s) at 0.082 s, the highest 0.010-s occupant ridedown acceleration was 10.0 g's from 0.161 to 0.171 s, and the maximum 0.050-s average was 14.3 g's between 0.027 and 0.077 s. These data and other information pertinent to the test are presented in Figure 33. Vehicle angular displacements and accelerations versus time traces are shown in Appendix F, Figures 49 and 68 through 73, respectively.

Assessment of Test Results

An assessment of the test based on the applicable *NCHRP Report 350* safety evaluation criteria is provided below.

◆ Structural Adequacy

- A. *Test article should contain and redirect the vehicle; the vehicle should not penetrate, underide, or override the installation although controlled lateral deflection of the test article is acceptable.*

Results: The TxDOT T77 bridge rail contained and redirected the small car. The vehicle did not penetrate, underide, or override the installation. Maximum dynamic deflection of the rail was not measurable.



Figure 29. After Impact Trajectory for Test 442882-4.



Figure 30. Installation after Test 442882-4.



Figure 31. Vehicle after Test 442882-4.

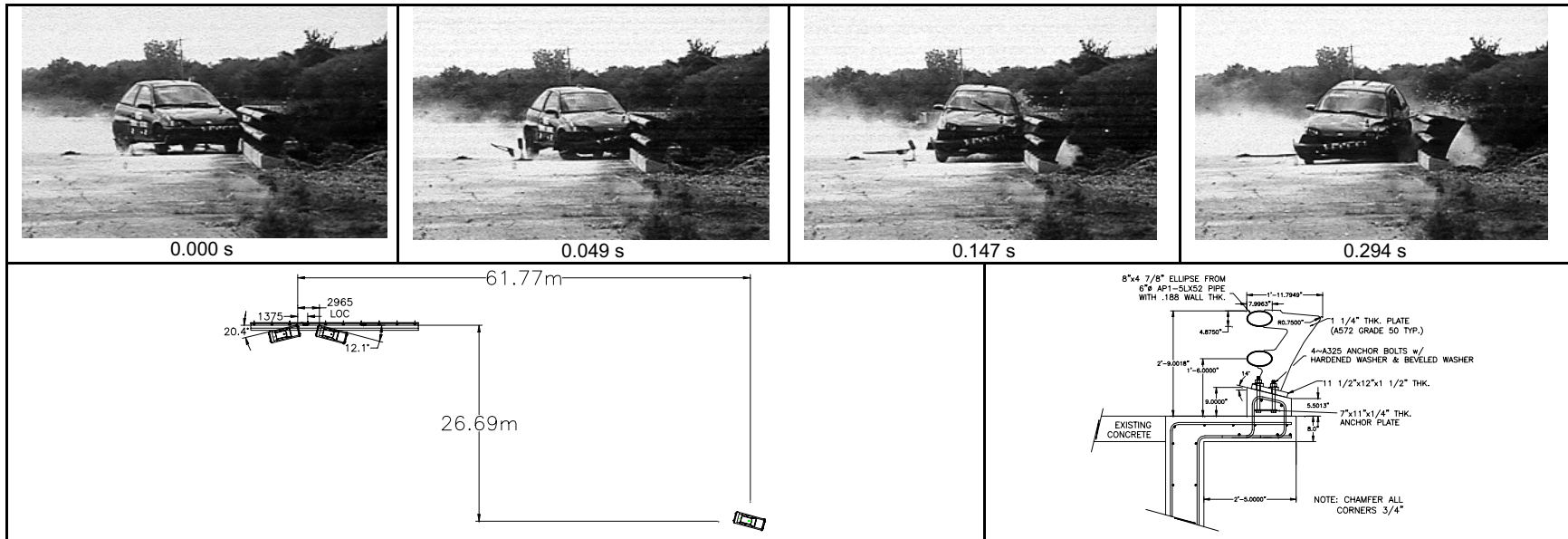


Before Test



After Test

Figure 32. Interior of Vehicle for Test 442882-4.



63

General Information

Test Agency Texas Transportation Institute
 Test No. 442882-4
 Date 08/27/02

Test Article

Type Bridge Rail
 Name T77 Aesthetic Bridge Rail
 Installation Length (ft) 75 (22.7 m)
 Material or Key Elements Tubular Steel Rail Elements Mounted On Steel "7" Shaped Posts

Soil Type and Condition Concrete Footing

Test Vehicle

Type Production
 Designation 820C
 Model 1997 Geo Metro
 Mass (lbs)
 Curb 1792 (814 kg)
 Test Inertial 1806 (820 kg)
 Dummy 169 (77 kg)
 Gross Static 1976 (897 kg)

Impact Conditions

Speed (mi/h) 61.6 (99.1 km/h)
 Angle (deg) 20.4

Exit Conditions

Speed (mi/h) 51.0 (82.0 km/h)
 Angle (deg) 12.1

Occupant Risk Values

Impact Velocity (ft/s)
 x-direction 16.7 (5.1 m/s)
 y-direction 25.6 (7.8 m/s)
 THIV (mph) 19.8 (31.9 km/h)
 Ridedown Accelerations (g's)
 x-direction -2.3
 y-direction 10.0
 PHD (g's) 10.0
 ASI 1.79
 Max. 0.050-s Average (g's)
 x-direction -9.8
 y-direction 14.3
 z-direction -3.2

Test Article Deflections (ft)

Dynamic None
 Permanent 0.04 (0.01 m)
 Working Width 1.90 (0.58 m)

Vehicle Damage

Exterior
 VDS 11FL2
 CDC 11LFEW2
 Maximum Exterior
 Vehicle Crush (in) 8.9 (230 mm)
 Interior
 OCDI LF0010000
 Max. Occ. Compart.
 Deformation (in) 1.0 (25 mm)

Post-Impact Behavior

(during 1.0 s after impact)
 Max. Yaw Angle (deg) 38.2
 Max. Pitch Angle (deg) -3.2
 Max. Roll Angle (deg) -14.2

Figure 33. Summary of Results for Test 442882-4, NCHRP Report 350 Test 3-10.

◆ **Occupant Risk**

D. *Detached elements, fragments, or other debris from the test article should not penetrate or show potential for penetrating the occupant compartment, or present an undue hazard to other traffic, pedestrians, or personnel in a work zone. Deformation of, or intrusions into, the occupant compartment that could cause serious injuries should not be permitted.*

Results: No detached elements, fragments, or other debris were present to penetrate or to show potential for penetrating the occupant compartment, or to present undue hazard to others in the area. Maximum occupant compartment deformation was 1.0 inch (25 mm) in the left front firewall area and the left side kickpanel area.

F. *The vehicle should remain upright during and after collision although moderate roll, pitching, and yawing are acceptable.*

Results: The small car remained upright during and after the collision event.

H. *Occupant impact velocities should satisfy the following:*

Longitudinal and Lateral Occupant Impact Velocity – m/s

<u>Preferred</u>	<u>Maximum</u>
9	12

Results: Longitudinal occupant impact velocity was 16.7 ft/s (5.1 m/s), and lateral occupant impact velocity was 25.6 ft/s (7.8 m/s).

I. *Occupant ridedown accelerations should satisfy the following:*

Longitudinal and Lateral Occupant Ridedown Accelerations – g's

<u>Preferred</u>	<u>Maximum</u>
15	20

Results: Longitudinal occupant ridedown acceleration was –2.3 g's, and lateral occupant ridedown acceleration was 10.0 g's.

◆ **Vehicle Trajectory**

K. *After collision, it is preferable that the vehicle's trajectory not intrude into adjacent traffic lanes.*

Results: The vehicle came to rest 202.7 ft (61.8 m) downstream of impact and 87.6 ft (26.7 m) forward of the traffic face of the rail.

M. *The exit angle from the test article preferably should be less than 60 percent of the test impact angle, measured at time of vehicle loss of contact with the test device.*

Results: Exit angle at loss of contact with the bridge rail was 12.1 degrees, which is 60 percent of the impact angle.

The following supplemental evaluation factors and terminology, as presented in the FHWA memo entitled “Action: Identifying Acceptable Highway Safety Features,” were used for visual assessment of test results:

◆ **Passenger Compartment Intrusion**

1. Windshield Intrusion
 - a. No windshield contact
 - b. Windshield contact, no damage
 - c. Windshield contact, no intrusion
 - d. Device embedded in windshield, no significant intrusion
 - e. Complete intrusion into passenger compartment
 - f. Partial intrusion into passenger compartment
2. Body Panel Intrusion yes or no

◆ **Loss of Vehicle Control**

1. Physical loss of control
2. Loss of windshield visibility
3. Perceived threat to other vehicles
4. Debris on pavement

◆ **Physical Threat to Workers or Other Vehicles**

1. Harmful debris that could injure workers or others in the area
 2. Harmful debris that could injure occupants in other vehicles
- No debris was present.

◆ **Vehicle and Device Condition**

1. Vehicle Damage
 - a. None
 - b. Minor scrapes, scratches or dents
 - c. Significant cosmetic dents
 - d. Major dents to grill and body panels
 - e. Major structural damage
2. Windshield Damage
 - a. None
 - b. Minor chip or crack (stress cracks)
 - c. Broken, no interference with visibility
 - d. Broken or shattered, visibility restricted but remained intact
 - e. Shattered, remained intact but partially dislodged
 - f. Large portion removed
 - g. Completely removed
3. Device Damage
 - a. None
 - b. Superficial
 - c. Substantial, but can be straightened
 - d. Substantial, replacement parts needed for repair
 - e. Cannot be repaired

CHAPTER 4. SUMMARY AND CONCLUSIONS

SUMMARY OF RESULTS

F411 Bridge Rail

Test 442882-1 (NCHRP Report 350 test 3-11)

The TxDOT F411 bridge rail contained and redirected the pickup truck. No measurable deflection occurred. No detached elements, fragments, or other debris were present to penetrate or to show potential for penetrating the occupant compartment, or to present undue hazard to others in the area. However, maximum deformation of the occupant compartment was 8.3 inches (210 mm) in the door area, 7.3 inches (186 mm) in the right floor pan area, and 6.9 inches (175 mm) in the right firewall area. The pickup truck remained upright during and after the collision period. The pickup truck came to rest 157.5 ft (48.0 m) downstream of impact and 7.5 ft (2.3 m) behind the traffic face of the bridge rail. Longitudinal occupant impact velocity was 26.2 ft/s (8.0 m/s) and longitudinal ridedown acceleration was -6.0 g's. Exit angle at loss of contact with the bridge rail was 7.3 degrees, which is 29 percent of the impact angle.

Test 442882-2 (NCHRP Report 350 test 3-11)

The modified TxDOT F411 bridge rail contained and redirected the pickup truck. No measurable deflection occurred. No detached elements, fragments, or other debris were present to penetrate or to show potential for penetrating the occupant compartment, or to present undue hazard to others in the area. Deformation of the occupant compartment was 4.6 inches (118 mm) in the instrument panel area and 4.1 inches (105 mm) in the firewall area. The factory-installed opening, which accommodates the manual transmission floor shift, tore at the forward and rear corners, increasing the opening to 7.1 inches (180 mm) long and 6.3 inches (160 mm) wide. (The dimensions of the factory-installed opening for the floor shift was originally 5.6 inches (143 mm) by 5.6 inches [143 mm]). No other separation in the floor pan or toe pan was noted. The pickup truck remained upright during and after the collision period. The pickup truck came to rest 221.4 ft (67.5 m) downstream of impact and 15.6 ft (4.8 m) forward of the traffic face of the bridge rail. Longitudinal occupant impact velocity was 24.6 ft/s (7.5 m/s) and longitudinal ridedown acceleration was -6.7 g's. Exit angle at loss of contact with the bridge rail was 4.5 degrees, which is 17 percent of the impact angle.

T77 Bridge Rail

Test 442882-3 (NCHRP Report 350 test 3-11)

The TxDOT T77 bridge rail contained and redirected the pickup truck. The vehicle did not penetrate, underide, or override the bridge rail. Maximum dynamic deflection of the rail was 1.9 inches (47 mm). No detached elements, fragments, or other debris were present to penetrate or to show potential for penetrating the occupant compartment, or to present undue hazard to others in the area. Maximum occupant compartment deformation was 8.7 inches (222 mm). The pickup truck remained upright during and after the collision event. The vehicle

came to rest 187.6 ft (57.2 m) downstream of impact and 12.5 ft (3.8 m) forward of the face of the rail. Longitudinal occupant impact velocity was 21.6 ft/s (6.6 m/s), and longitudinal ridedown acceleration was -5.6 g's. Exit angle at loss of contact was 10.8 degrees, which was 44 percent of the impact angle.

Test 442882-4 (NCHRP Report 350 test 3-10)

The TxDOT T77 bridge rail contained and redirected the small car. The vehicle did not penetrate, underide, or override the installation. Maximum dynamic deflection of the rail was not measurable. No detached elements, fragments, or other debris were present to penetrate or to show potential for penetrating the occupant compartment, or to present undue hazard to others in the area. Maximum occupant compartment deformation was 1.0 inches (25 mm) in the left front firewall area and the left side kickpanel area. The small car remained upright during and after the collision event. Longitudinal occupant impact velocity was 16.7 ft/s (5.1 m/s) and lateral occupant impact velocity was 25.6 ft/s (7.8 m/s). Longitudinal occupant ridedown acceleration was -2.3 g's, and lateral occupant ridedown acceleration was 10.0 g's. The vehicle came to rest 202.7 ft (61.8 m) downstream of impact and 87.6 ft (26.7 m) forward of the traffic face of the rail. Exit angle at loss of contact was 12.1 degrees, which was 60 percent of the impact angle.

CONCLUSIONS

As shown in [Table 1](#), the first test on the F411 bridge rail did not meet the requirements for occupant risk for *NCHRP Report 350* test 3-11. The modified F411 bridge rail did meet the required specifications for *NCHRP Report 350* test 3-11, as summarized in [Table 2](#).

The T77 bridge rail did not meet the occupant risk requirements for *NCHRP Report 350* test 3-11 due to excessive occupant compartment deformation; however, the T77 bridge rail did perform acceptably during *NCHRP Report 350* test 3-10. [Tables 3](#) and [4](#) summarize the evaluation of these two tests on the TxDOT T77 bridge rail.

IMPLEMENTATION STATEMENT

TTI researchers recommend implementation of the use of the modified F411 bridge rail as per the design used in the second crash test. The rail had been modified by enclosing the open space beneath the lower rail face with concrete to make it flush with the lower rail. Enclosing the bottom of the rail increased the effective surface contact area of the installation.

TTI researchers and TxDOT personnel will pursue development of modifications to ensure the T77 bridge rail performs in accordance with the evaluation criteria of *NCHRP Report 350*. Tentatively, modifications include improvement in the rail splice connection and increased wall thickness of the rail member. One additional *NCHRP Report 350* crash test (3-11) will be required to evaluate the performance of the T77 bridge rail with these modifications.

Table 1. Performance Evaluation Summary for Test 442882-1, NCHRP Report 350 Test 3-11.

Test Agency: Texas Transportation Institute	Test No.: 442882-1	Test Date: 05/06/2002
NCHRP Report 350 Test 3-11 Evaluation Criteria	Test Results	Assessment
<u>Structural Adequacy</u>		
A. Test article should contain and redirect the vehicle; the vehicle should not penetrate, underride, or override the installation although controlled lateral deflection of the test article is acceptable.	The TxDOT F411 bridge rail contained and redirected the pickup truck. No measurable deflection occurred.	Pass
<u>Occupant Risk</u>		
D. Detached elements, fragments, or other debris from the test article should not penetrate or show potential for penetrating the occupant compartment, or present an undue hazard to other traffic, pedestrians, or personnel in a work zone. Deformations of, or intrusions into, the occupant compartment that could cause serious injuries should not be permitted.	No detached elements, fragments, or other debris were present to penetrate or to show potential for penetrating the occupant compartment, or to present undue hazard to others in the area. Maximum deformation of the occupant compartment was 8.3 inches (210 mm) in the door area.	Fail
F. The vehicle should remain upright during and after collision although moderate roll, pitching, and yawing are acceptable.	The pickup truck remained upright during and after the collision period.	Pass
<u>Vehicle Trajectory</u>		
K. After collision it is preferable that the vehicle's trajectory not intrude into adjacent traffic lanes.	The pickup truck came to rest 7.5 ft (2.3 m) behind the traffic face of the bridge rail.	Pass*
L. The occupant impact velocity in the longitudinal direction should not exceed 12 m/s and the occupant ridedown acceleration in the longitudinal direction should not exceed 20 g's.	Longitudinal occupant impact velocity was 26.2 ft/s (8.0 m/s), and longitudinal ridedown acceleration was -6.0 g's.	Pass
M. The exit angle from the test article preferably should be less than 60 percent of test impact angle, measured at time of vehicle loss of contact with test device.	Exit angle at loss of contact with the bridge rail was 7.3 degrees, which is 29 percent of the impact angle.	Pass*

*Criterion K and M are preferable, not required.

Table 2. Performance Evaluation Summary for Test 442882-2, NCHRP Report 350 Test 3-11.

Test Agency: Texas Transportation Institute		Test No.: 442882-2	Test Date: 07/18/2002
<i>NCHRP Report 350 Test 3-11 Evaluation Criteria</i>		Test Results	Assessment
<u>Structural Adequacy</u>			
A.	Test article should contain and redirect the vehicle; the vehicle should not penetrate, underride, or override the installation although controlled lateral deflection of the test article is acceptable.	The modified TxDOT F411 bridge rail contained and redirected the pickup truck. No measurable deflection occurred.	Pass
<u>Occupant Risk</u>			
D.	Detached elements, fragments, or other debris from the test article should not penetrate or show potential for penetrating the occupant compartment, or present an undue hazard to other traffic, pedestrians, or personnel in a work zone. Deformations of, or intrusions into, the occupant compartment that could cause serious injuries should not be permitted.	No detached elements, fragments, or other debris were present. Deformation of the occupant compartment was 4.6 inches (118 mm) in the instrument panel area and 4.1 inches (105 mm) in the firewall area. The factory-installed opening, which accommodates the manual transmission floor shift, tore at the forward and rear corners, increasing the opening 7.1 inches (180 mm) long and 6.3 inches (160 mm) wide (original dimensions of opening were 5.6 inches x 5.6 inches [143 mm x 143 mm]). No other separation in the floor pan or toe pan was noted.	Pass
F.	The vehicle should remain upright during and after collision although moderate roll, pitching, and yawing are acceptable.	The pickup truck remained upright during and after the collision period.	Pass
<u>Vehicle Trajectory</u>			
K.	After collision it is preferable that the vehicle's trajectory not intrude into adjacent traffic lanes.	The pickup truck came to rest 221.4 ft (67.5 m) downstream of impact and 15.6 ft (4.8 m) forward of the traffic face of the bridge rail.	Fail*
L.	The occupant impact velocity in the longitudinal direction should not exceed 12 m/s and the occupant ridedown acceleration in the longitudinal direction should not exceed 20 g's.	Longitudinal occupant impact velocity was 24.6 ft/s (7.5 m/s), and longitudinal ridedown acceleration was -6.0 g's.	Pass
M.	The exit angle from the test article preferably should be less than 60 percent of test impact angle, measured at time of vehicle loss of contact with test device.	Exit angle at loss of contact with the bridge rail was 4.5 degrees, which is 17 percent of the impact angle.	Pass*

*Criterion K and M are preferable, not required.

Table 3. Performance Evaluation Summary for Test 442882-3, NCHRP Report 350 Test 3-11.

Test Agency: Texas Transportation Institute	Test No.: 442882-3	Test Date: 08/23/2002
NCHRP Report 350 Test 3-11 Evaluation Criteria	Test Results	Assessment
<u>Structural Adequacy</u>		
A. Test article should contain and redirect the vehicle; the vehicle should not penetrate, underride, or override the installation although controlled lateral deflection of the test article is acceptable.	The TxDOT T77 bridge rail contained and redirected the pickup truck. The vehicle did not penetrate, underride, or override the bridge rail. Maximum dynamic deflection of the rail was 1.9 inches (47 mm).	Pass
<u>Occupant Risk</u>		
D. Detached elements, fragments, or other debris from the test article should not penetrate or show potential for penetrating the occupant compartment, or present an undue hazard to other traffic, pedestrians, or personnel in a work zone. Deformations of, or intrusions into, the occupant compartment that could cause serious injuries should not be permitted.	No detached elements, fragments, or other debris were present to penetrate or to show potential for penetrating the occupant compartment, or to present undue hazard to others in the area. Maximum occupant compartment deformation was 8.7 inches (222 mm).	Fail
F. The vehicle should remain upright during and after collision although moderate roll, pitching, and yawing are acceptable.	The pickup truck remained upright during and after the collision event.	Pass
<u>Vehicle Trajectory</u>		
K. After collision it is preferable that the vehicle's trajectory not intrude into adjacent traffic lanes.	The vehicle came to rest 187.6 ft (57.2 m) downstream of impact and 12.5 ft (3.8 m) forward of the face of the rail.	Pass*
L. The occupant impact velocity in the longitudinal direction should not exceed 12 m/s, and the occupant ridedown acceleration in the longitudinal direction should not exceed 20 g's.	Longitudinal occupant impact velocity was 21.6 ft/s (6.6 m/s) and longitudinal ridedown acceleration was -5.6 g's.	Pass
M. The exit angle from the test article preferably should be less than 60 percent of test impact angle, measured at time of vehicle loss of contact with test device.	Exit angle at loss of contact was 10.8 degrees, which was 44 percent of the impact angle.	Pass*

*Criterion K and M are preferable, not required.

Table 4. Performance Evaluation Summary for Test 442882-4, NCHRP Report 350 Test 3-10.

Test Agency: Texas Transportation Institute		Test No.: 442882-4	Test Date: 08/27/2002	
NCHRP Report 350 Test 3-10 Evaluation Criteria		Test Results	Assessment	
<u>Structural Adequacy</u>				
A.	Test article should contain and redirect the vehicle; the vehicle should not penetrate, underride, or override the installation although controlled lateral deflection of the test article is acceptable.	The TxDOT T77 bridge rail contained and redirected the small car. The vehicle did not penetrate, underride, or override the installation. Maximum dynamic deflection of the rail was not measurable.	Pass	
<u>Occupant Risk</u>				
D.	Detached elements, fragments, or other debris from the test article should not penetrate or show potential for penetrating the occupant compartment, or present an undue hazard to other traffic, pedestrians, or personnel in a work zone. Deformations of, or intrusions into, the occupant compartment that could cause serious injuries should not be permitted.	No detached elements, fragments, or other debris were present to penetrate or to show potential for penetrating the occupant compartment, or to present undue hazard to others in the area. Maximum occupant compartment deformation was 1.0 inch (25 mm) in the left front firewall area and the left side kickpanel area.	Pass	
F.	The vehicle should remain upright during and after collision although moderate roll, pitching, and yawing are acceptable.	The small car remained upright during and after the collision event.	Pass	
H.	Occupant impact velocities should satisfy the following:	Longitudinal occupant impact velocity was 16.7 ft/s (5.1 m/s), and lateral occupant impact velocity was 25.6 ft/s (7.8 m/s).	Pass	
	Occupant Velocity Limits (m/s)			
	Component			Preferred
	Longitudinal and lateral	9	12	
I.	Occupant ridedown accelerations should satisfy the following:	Longitudinal occupant ridedown acceleration was -2.3 g's, and lateral occupant ridedown acceleration was 10.0 g's.	Pass	
	Occupant Ridedown Acceleration Limits (g's)			
	Component			Preferred
	Longitudinal and lateral	15	20	
<u>Vehicle Trajectory</u>				
K.	After collision, it is preferable that the vehicle's trajectory not intrude into adjacent traffic lanes.	The vehicle came to rest 202.7 ft (61.8 m) downstream of impact and 87.6 ft (26.7 m) forward of the traffic face.	Fail*	
M.	The exit angle from the test article preferably should be less than 60 percent of test impact angle, measured at time of vehicle loss of contact with test device.	Exit angle at loss of contact was 12.1 degrees, which was 60 percent of the impact angle.	Marginal*	

*Criterion K and M are preferable, not required.

REFERENCES

1. Ross, H.E., Jr., Sicking, D.L., Zimmer, R.A., and Michie, J.D., *Recommended Procedures for the Safety Performance Evaluation of Highway Features*, National Cooperative Highway Research Program Report 350, Transportation Research Board, National Research Council, Washington, D.C., 1993.
2. *A Policy on Geometric Design of Highways and Streets*, Fourth Edition, (Green Book) American Association of State Highway and Transportation Officials, Washington, D.C., 2001.
3. *Flexibility in Highway Design*, Federal Highway Department, Publication No. FHWA-PD-97-062, Washington, D.C., September 1997.
4. Bullard, D.L., Jr., Menges, W.L., and Schoeneman, S.K., *NCHRP Report 350 Test 3-11 of the Steel-Backed Timber Guardrail*, Project 405181-2, Texas Transportation Institute, College Station, TX, June 2001.
5. Bullard, D.L., Jr., Menges, W.L., and Haug, R.R., *NCHRP Report 350 Test 2-11 of the Type B Steel-Backed Timber Guardrail*, Project 405181-13, Texas Transportation Institute, College Station, TX, October 2001.
6. Bullard, D.L., Jr., Menges, W.L., Buth, C.E., and Sanders, S.K., *NCHRP Report 350 Test 3-11 on the Rough Stone Masonry Guardwall*, Project No. 405181-1, Texas Transportation Institute, College Station, TX, September 2000.
7. Zimmer, R.A., and Campise, W.L., *Traffic Barriers for Parkways and Performance Evaluation of a Stone Masonry Guardwall*, Publication No. FHWA/RD-85/066, Washington, D.C., 1985.
8. Mak, K.K., and Alberson, D.C., *Test Report 7212-1*, Project No. RF72120, Texas A&M Research Foundation, Texas Transportation Institute, Prepared for The Constructed Facilities Center, West Virginia University, May 1993.
9. Mak, K.K., and Alberson, D.C., *Test Report 7212-2*, Project No. 7212-2, Texas A&M Research Foundation, Texas Transportation Institute, Prepared for The Constructed Facilities Center, West Virginia University, May 1993.
10. Holloway, J.C., Faller, R.K., Pfeifer, B.G., and Post, E.R., *Full-Scale 18,000-lb Vehicle Crash Test on the Kansas 32 Inch Corral Rail*, Final Report to the Kansas Department of Transportation, Report No. TRP-03-26-91, Project RES1 (0099) P450, Civil Engineering Department, University of Nebraska-Lincoln, June 1991.

11. Bligh, R.P., and Bullard, L., *Analysis and Testing of Oregon DOT Steel-Backed Timber Guardrail*, Research Report RF 7161-1F, Texas Transportation Institute, College Station, TX, March 1991.
12. Michie, J.D., *Recommended Procedures for the Safety Performance Evaluation of Highway Appurtenances*, National Cooperative Highway Research Program Report 230, Transportation Research Board, National Research Council, Washington, D.C., March 1981.
13. *2000 Interim AASHTO LRFD Bridge Design Specifications*, Customary U.S. Units, Second Edition, American Association of State Highway and Transportation Officials, Washington, D.C., 1998.

APPENDIX A. DESIGN CALCULATIONS FOR F411 BRIDGE RAIL

SUBJECT TxDOT F411 Bridge Rail

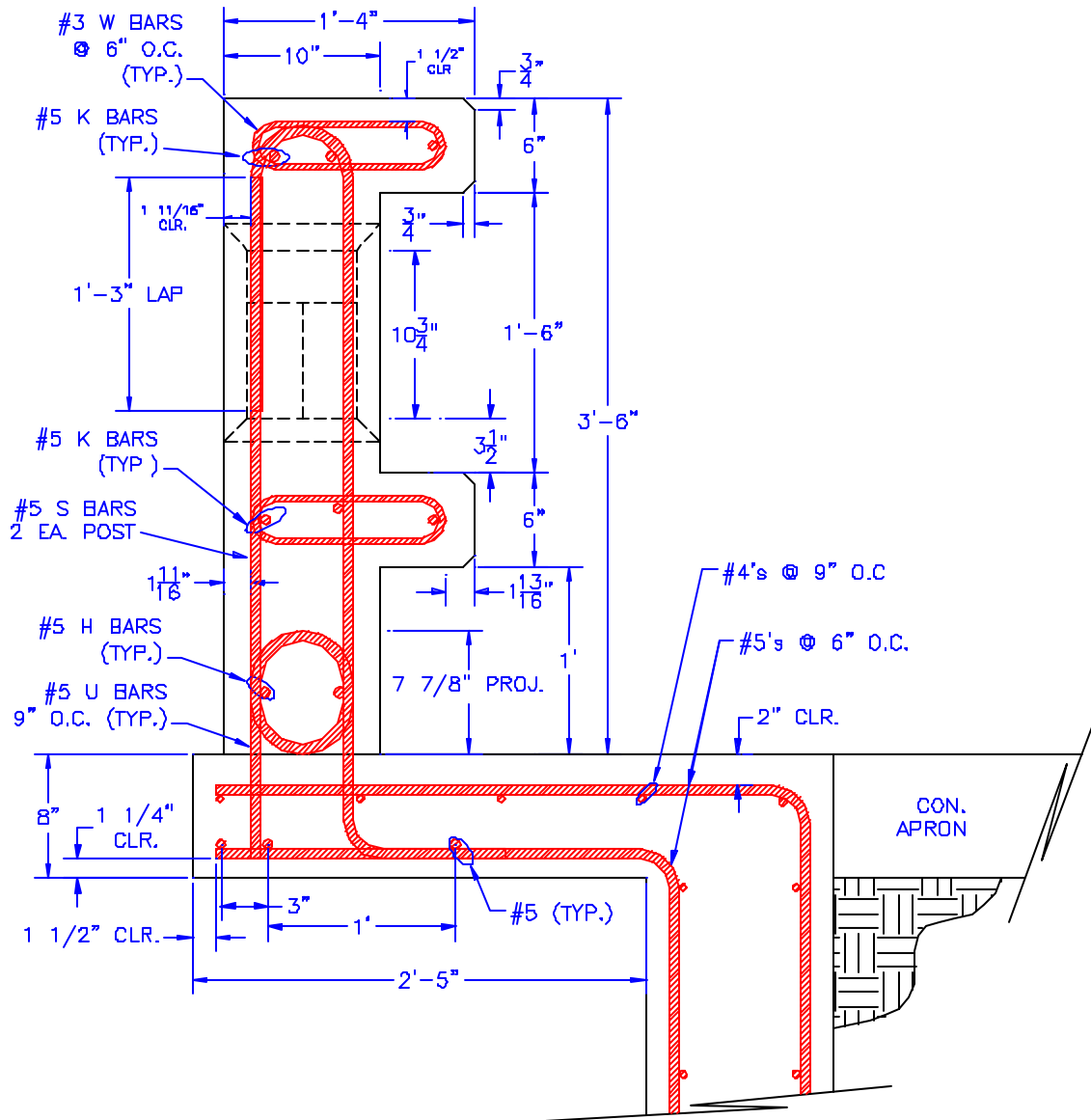
Design / Analysis

BY: W. Williams

CKD: _____

CLIENT TxDOT

Given: 1.) Given the Following Cross Section, Calculate the Total Transverse Resistance (R_w) of the railing based on AASHTO LRFD, Section 13 Specifications:



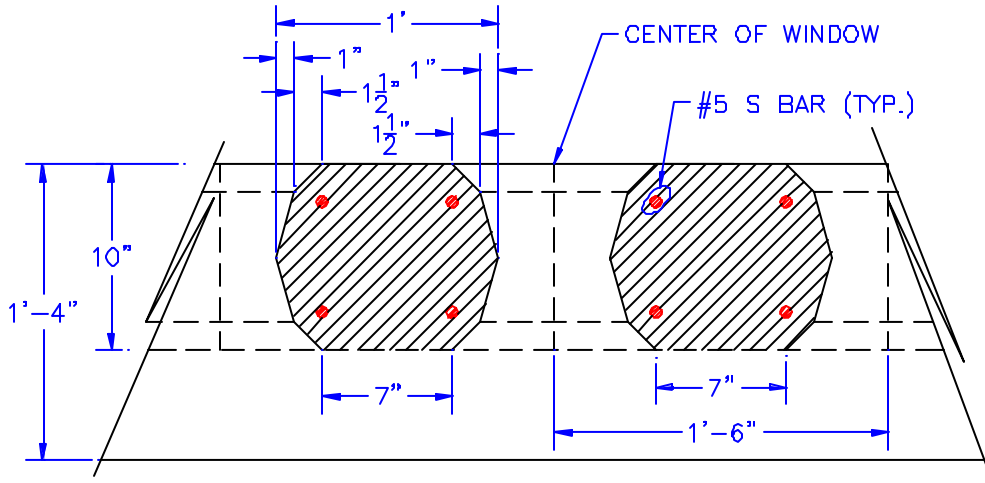
SUBJECT TxDOT F411 Bridge Rail

BY: W. Williams

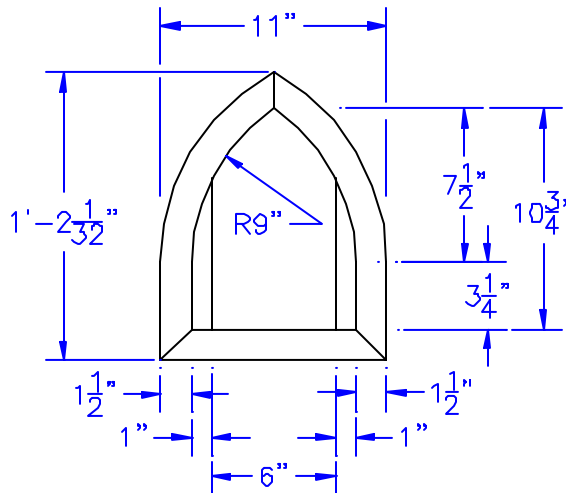
Design / Analysis

CKD: _____

CLIENT TxDOT



POST PLAN DETAILS



DETAIL 1 ~ WINDOW DETAILS

Rectangular windows used in lieu of Detail 1 as shown

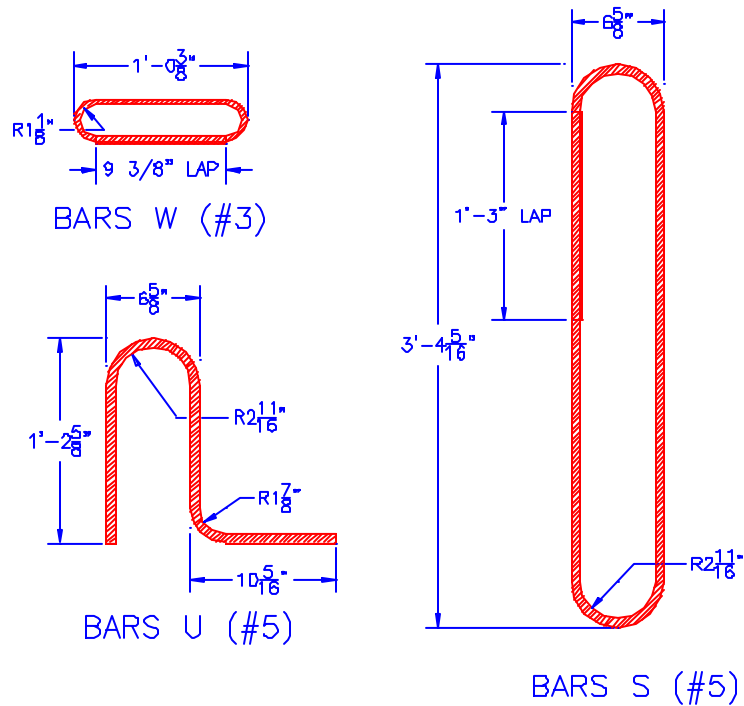
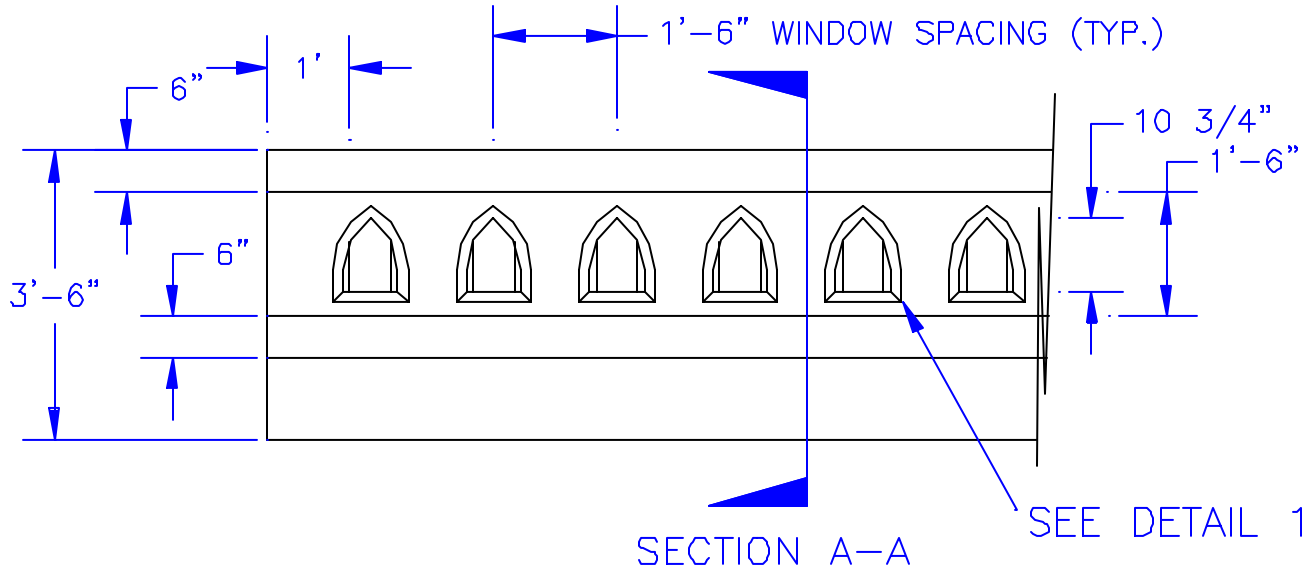
SUBJECT TxDOT F411 Bridge Rail

BY: W. Williams

Design / Analysis

CKD: _____

CLIENT TxDOT



SUBJECT TxDOT F411 Bridge Rail

Design / Analysis

CLIENT TxDOT

BY: W. Williams

CKD: _____

2.) Given the Following Design Data:

28 day compressive strength of the rail concrete:

$$f'_c := 3600 \cdot \text{psi}$$

28 day compressive strength of the slab concrete:

$$f'_{c\text{slab}} := 4000 \text{psi}$$

Width of the Post Section

$$b_{\text{post}} := 11 \text{in}$$

Post Thickness (t_{post}):

$$t_{\text{post}} := 10 \text{in}$$

Concrete Clear Cover:

$$\text{cover}_{\text{post}} := 1 \text{in} + \frac{11}{16} \text{in}$$

Bar Size in the Post (tension face):

$$\text{BarDia}_{\text{post}} := \frac{5}{8} \cdot \text{in}$$

Effective Depth of the Wall rebar (d_{wall}):

$$d_{\text{post}} := t_{\text{post}} - \text{cover}_{\text{post}} - .5 \cdot (\text{BarDia}_{\text{post}})$$

$$d_{\text{post}} = 8 \text{in}$$

Yield Strength of the Reinforcing Steel (F_y):

$$F_y := 60 \cdot \text{ksi}$$

Total Area of Steel in the Tension layer of each post: 2 ~ #5's:

$$A_{\text{stpost}} := 2 \cdot (.31 \cdot \text{in}^2)$$

$$A_{\text{stpost}} = 0.62 \text{in}^2$$

Concrete Factor for 3600 *psi Concrete:

$$\beta_1 := 0.85$$

Unit Weight of Concrete:

$$\gamma_{\text{concrete}} := 145 \text{pcf}$$

Calculate d_{rail} (neglect 1~ #5 in compression face) and determine weighted average for 2~#5 in Tension distances of each bar from compression face determined graphically in AutoCad:

$$d_{\text{rail}} := \frac{12.875 \text{in} + 9.25 \text{in}}{2}$$

$$d_{\text{rail}} = 11.06 \text{in}$$

Thickness of Rail(s):

$$b_{\text{rail}} := 6 \text{in}$$

SUBJECT TxDOT F411 Bridge Rail
Design / Analysis
 CLIENT TxDOT

BY: W. Williams
 CKD: _____

3.) Calculate the Nominal Strength of the Post:

2~#5's in Post @ 6" O.C.

3a.) Calculate "ρ":

$$A_{stpost} = 0.62 \text{ in}^2 \quad b_{post} = 11 \text{ in} \quad d_{post} = 8 \text{ in}$$

$$\rho_{post} := \frac{A_{stpost}}{b_{post} \cdot d_{post}} \quad \rho_{post} = 0.00705$$

3b.) Calculate "ρ_{min}":

$$\rho_{min1} := \frac{200 \cdot \text{psi}}{F_y} \quad \rho_{min1} = 0.00333$$

$$f_c = 3600 \text{ psi}$$

$$F_y = 60 \text{ ksi}$$

$$\rho_{min2} := \frac{3 \cdot \sqrt{\frac{f_c}{\text{psi}} \cdot \text{psi}}}{F_y} \quad \rho_{min2} = 0.003$$

Use ρ_{min1}.... Therefore ρ_{post} > ρ_{min1} ... O.K. !

3c.) Calculate ρ_{bal} for the Post:

$$\rho_{bal} := \beta_1 \cdot \left(\frac{0.85 \cdot f_c}{F_y} \right) \cdot \left(\frac{87000 \cdot \text{psi}}{87000 \cdot \text{psi} + F_y} \right)$$

$$\rho_{bal} = 0.03 \quad 0.75 \cdot \rho_{bal} = 0.0192$$

3d.) Check to make sure ρ_{post} is less than or equal to 0.75ρ_{bal}:

ρ_{post} is between ρ_{min1} and 0.75ρ_{bal} therefore ... O.K. !

SUBJECT TxDOT F411 Bridge Rail
Design / Analysis
 CLIENT TxDOT

BY: W. Williams
 CKD: _____

3e.) Calculate "a" the height of the rectangular stress block:

Given: $A_{stpost} = 0.62 \text{ in}^2$
 $F_y = 60 \text{ ksi}$
 $f_c = 3.6 \text{ ksi}$
 $b_{post} = 11 \text{ in}$

Therefore:

$$a_{post} := \frac{A_{stpost} \cdot F_y}{0.85 \cdot f_c \cdot b_{post}}$$

$$a_{post} = 1.11 \text{ in}$$

3f.) Calculate the Nominal moment Capacity of the Post:

Given: $d_{post} := 8 \text{ in}$
 $A_{stpost} = 0.62 \text{ in}^2$
 $F_y = 60 \text{ ksi}$
 $a_{post} = 1.11 \text{ in}$

$$M_{npost} := A_{stpost} \cdot F_y \cdot \left(d_{post} - \frac{a_{post}}{2} \right)$$

$M_{npost} = 23.09 \text{ kip} \cdot \text{ft}$ say 23 kip*ft each post

SUBJECT TxDOT F411 Bridge Rail
Design / Analysis
 CLIENT TxDOT

BY: W. Williams
 CKD: _____

4.) Calculate the Nominal Strength of the Two Rails (use geometry of Top rail as worst case):

2~#5's in 6" X 1'-4" Beam

4a.) Calculate "ρ":

$$A_{\text{strail}} := 2 \cdot 0.31 \text{ in}^2 \quad b_{\text{rail}} = 6 \text{ in} \quad d_{\text{rail}} = 11.06 \text{ in}$$

$$\rho_{\text{rail}} := \frac{A_{\text{strail}}}{b_{\text{rail}} \cdot d_{\text{rail}}} \quad \rho_{\text{rail}} = 0.00934$$

4b.) Calculate "ρ_{min}":

$$\rho_{\text{min1}} := \frac{200 \cdot \text{psi}}{F_y} \quad \rho_{\text{min1}} = 0.00333$$

$$f_c = 3600 \text{ psi}$$

$$F_y = 60 \text{ ksi}$$

$$\rho_{\text{min2}} := \frac{3 \cdot \sqrt{\frac{f_c}{\text{psi}} \cdot \text{psi}}}{F_y} \quad \rho_{\text{min2}} = 0.003$$

Use ρ_{min1}.... Therefore ρ_{rail} > ρ_{min1} ... O.K. !

4c.) Calculate ρ_{bal} for the Rails:

$$\rho_{\text{bal}} := \beta_1 \cdot \left(\frac{0.85 \cdot f_c}{F_y} \right) \cdot \left(\frac{87000 \cdot \text{psi}}{87000 \cdot \text{psi} + F_y} \right)$$

$$\rho_{\text{bal}} = 0.03 \quad 0.75 \cdot \rho_{\text{bal}} = 0.0192$$

4d.) Check to make sure ρ_{post} is less than or equal to 0.75ρ_{bal}:

ρ_{post} is between ρ_{min1} and 0.75ρ_{bal} therefore ... O.K. !

SUBJECT TxDOT F411 Bridge Rail
Design / AnalysisBY: W. Williams
CKD: _____CLIENT TxDOT

4e.) Calculate "a" the height of the rectangular stress block:

Given: $A_{\text{strail}} = 0.62 \text{ in}^2$
 $F_y = 60 \text{ ksi}$
 $f_c = 3.6 \text{ ksi}$
 $b_{\text{rail}} = 6 \text{ in}$

Therefore:

$$a_{\text{rail}} := \frac{A_{\text{strail}} \cdot F_y}{0.85 \cdot f_c \cdot b_{\text{rail}}}$$

$$a_{\text{rail}} = 2.03 \text{ in}$$

4f.) Calculate the Nominal moment Capacity of the Rails:

Given: $d_{\text{rail}} = 11.06 \text{ in}$
 $A_{\text{strail}} = 0.62 \text{ in}^2$
 $F_y = 60 \text{ ksi}$
 $a_{\text{rail}} = 2.03 \text{ in}$

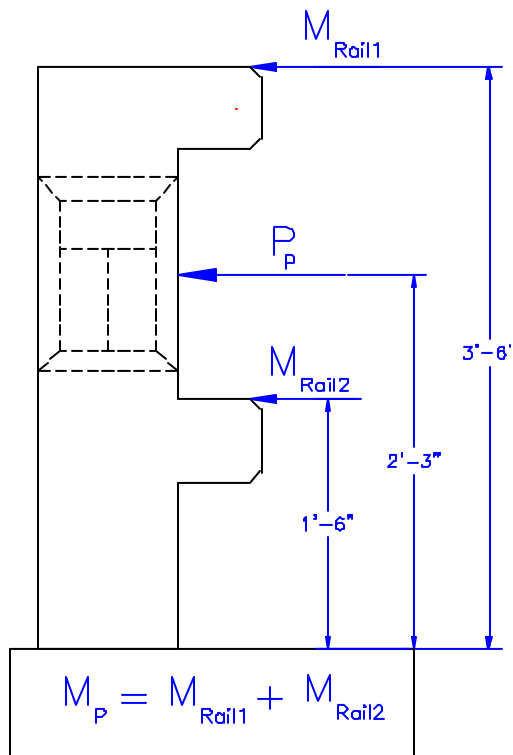
$$M_{\text{nrail}} := A_{\text{strail}} \cdot F_y \cdot \left(d_{\text{rail}} - \frac{a_{\text{rail}}}{2} \right)$$

$$M_{\text{nrail}} = 31.15 \text{ kip} \cdot \text{ft} \quad \text{..... say 31kip} \cdot \text{ft each post}$$

SUBJECT TxDOT F411 Bridge Rail
Design / Analysis
 CLIENT TxDOT

BY: W. Williams
 CKD: _____

4.) Check the Capacity of the Railing using AASHTO LRFD Section 13:



$$M_p := M_{nrail} \cdot 2 \quad M_p = 62.31 \text{ kip} \cdot \text{ft}$$

$$P_p := \frac{M_{npost}}{27 \text{ in}}$$

$$L := 1.5 \cdot \text{ft} \quad \text{Post Spacing in Feet}$$

$$L_t := 3.5 \text{ ft}$$

4a.) Calculate Capacity for a Single Span: $N := 1$

$$R_1 := \frac{16 \cdot M_p + (N - 1) \cdot (N + 1) \cdot P_p \cdot L}{(2 \cdot N \cdot L) - L_t}$$

$$R_1 = -1993.8 \text{ kips}$$

4b.) Calculate Capacity for a Double Span: $N := 2$

$$R_2 := \frac{16 \cdot M_p + (N^2) \cdot P_p \cdot L}{(2 \cdot N \cdot L) - L_t}$$

$$R_2 = 423.4 \text{ kips}$$

4c.) Calculate Capacity for 3 Post Spans: $N := 3$

$$R_3 := \frac{16 \cdot M_p + (N - 1) \cdot (N + 1) \cdot P_p \cdot L}{(2 \cdot N \cdot L) - L_t}$$

$$R_3 = 203.6 \text{ kips}$$

SUBJECT TxDOT F411 Bridge Rail

Design / Analysis

BY: W. Williams

CKD: _____

CLIENT TxDOT

4d.) Calculate Capacity for 4 Post Spans: $N := 4$

$$R_4 := \frac{16 \cdot M_p + (N^2) \cdot P_p \cdot L}{(2 \cdot N \cdot L) - L_t}$$

$$R_4 = 146.3 \text{ kips}$$

4e.) Calculate Capacity for 5 Post Spans: $N := 5$

$$R_5 := \frac{16 \cdot M_p + (N - 1) \cdot (N + 1) \cdot P_p \cdot L}{(2 \cdot N \cdot L) - L_t}$$

$$R_5 = 118.8 \text{ kips}$$

4f.) Calculate Capacity for 6 Post Spans: $N := 6$

$$R_6 := \frac{16 \cdot M_p + (N^2) \cdot P_p \cdot L}{(2 \cdot N \cdot L) - L_t}$$

$$R_6 = 107 \text{ kips}$$

4g.) Calculate Capacity for 7 Post Spans: $N := 7$

$$R_7 := \frac{16 \cdot M_p + (N - 1) \cdot (N + 1) \cdot P_p \cdot L}{(2 \cdot N \cdot L) - L_t}$$

$$R_7 = 99.2 \text{ kips}$$

4h.) Calculate Capacity for 8 Post Spans: $N := 8$

$$R_8 := \frac{16 \cdot M_p + (N^2) \cdot P_p \cdot L}{(2 \cdot N \cdot L) - L_t}$$

$$R_8 = 96.7 \text{ kips}$$

SUBJECT TxDOT F411 Bridge Rail

Design / Analysis

BY: W. Williams

CKD: _____

CLIENT TxDOT

4i.) Calculate Capacity for 9 Post Spans: N := 9

$$R_9 := \frac{16 \cdot M_p + (N - 1) \cdot (N + 1) \cdot P_p \cdot L}{(2 \cdot N \cdot L) - L_t}$$

R₉ = 94.8 kips

$$R_{9at32} := \frac{R_9 \cdot 27in}{32in}$$

R_{9at32} = 80 kips

4j.) Calculate Capacity for 10 Post Spans: N := 10

$$R_{10} := \frac{16 \cdot M_p + (N^2) \cdot P_p \cdot L}{(2 \cdot N \cdot L) - L_t}$$

R₁₀ = 95.7 kips

4k.) Calculate Capacity for 11 Post Spans: N := 11

$$R_{11} := \frac{16 \cdot M_p + (N - 1) \cdot (N + 1) \cdot P_p \cdot L}{(2 \cdot N \cdot L) - L_t}$$

R₁₁ = 96.4 kips

4l.) Calculate Capacity for 12 Post Spans: N := 12

$$R_{12} := \frac{16 \cdot M_p + (N^2) \cdot P_p \cdot L}{(2 \cdot N \cdot L) - L_t}$$

R₁₂ = 98.9 kips

SUBJECT TxDOT F411 Bridge Rail

Design / Analysis

BY: W. Williams

CKD: _____

CLIENT TxDOT

5.) Check Nominal Strength of the 8-inch Thick Slab:

Given: $d_{slab} := 8\text{in} - 2\text{in} - \frac{5}{16}\text{in}$ (slab thickness-cover-1/2 bar diameter)

$$d_{slab} = 5.69\text{ in}$$

$$A_{stslab} := .62\text{in}^2 \quad \#5\text{'s @ 6 inches O.C.}$$

$$F_y = 60\text{ ksi}$$

$$f'_{cslab} = 4 \times 10^3\text{ psi}$$

$$b_{slab} := 12\text{in}$$

Therefore:

$$a_{slab} := \frac{A_{stslab} \cdot F_y}{0.85 \cdot f'_{cslab} \cdot b_{slab}}$$

$$a_{slab} = 0.91\text{ in}$$

$$M_{nslab} := A_{stslab} \cdot F_y \cdot \left(d_{slab} - \frac{a_{slab}}{2} \right)$$

$$M_{nslab} = 16.22\text{ kip}\cdot\text{ft} \quad \text{..... say 13.50 kip}\cdot\text{ft per foot of slab width}$$

SUBJECT TxDOT F411 Bridge Rail

Design / Analysis

BY: W. Williams

CKD: _____

CLIENT TxDOT

**6.) Check Nominal Strength of the T7 @ "U" Bar Connection:
Use "U" Bar Spacing @ 9 inches on centers**

$$d_{\text{Ubars}} := 3\text{in} + 4.25\text{in} + \frac{5}{16}\text{in}$$

Given: $A_{\text{stUbars}} := \frac{(12 \cdot .31 \cdot \text{in}^2)}{9}$ #5's @ 9" O.C.

$$F_y = 60 \text{ ksi}$$

$$A_{\text{stUbars}} = 0.41 \text{ in}^2$$

$$f_c = 3600 \text{ psi}$$

$$b_{\text{T7}} := 12\text{in}$$

Therefore:

$$a_{\text{Ubars}} := \frac{A_{\text{stUbars}} \cdot F_y}{0.85 \cdot f_c \cdot b_{\text{T7}}}$$

$$a_{\text{Ubars}} = 0.68 \text{ in}$$

$$M_{\text{nUbars}} := A_{\text{stUbars}} \cdot F_y \cdot \left(d_{\text{Ubars}} - \frac{a_{\text{Ubars}}}{2} \right)$$

$$M_{\text{nUbars}} = 14.93 \text{ kip} \cdot \text{ft} \quad \dots \text{ say } 12.7 \text{ kip} \cdot \text{ft per foot of Rail Length}$$

$$M_{\text{nslab}} = 16.22 \text{ kip} \cdot \text{ft}$$

The nominal Strength of the "U" Bars is very close to the strength of the slab.... O.K.!

SUBJECT TxDOT F411 Bridge Rail

Design / Analysis

CLIENT TxDOT

BY: W. Williams

CKD: _____

**7.) Check Nominal Vertical Strength per foot of Rail
Use "U" Bar Spacing @ 9 inches on centers**

$$t_{\text{beam}} := 6\text{in}$$

$$d_{\text{beam}} := t_{\text{beam}} - 1.5\text{in} - \frac{3}{16}\text{in}$$

$$d_{\text{beam}} = 4.31\text{in}$$

Given: $A_{\text{stbeam}} := (2 \cdot .11 \cdot \text{in}^2)$ #3's @ 6" O.C.

$$F_y = 60\text{ksi}$$

$$A_{\text{stUbars}} = 0.41\text{in}^2$$

$$f_c = 3600\text{psi}$$

$$b_{\text{beam}} := 12\text{in}$$

Therefore:

$$a_{\text{beam}} := \frac{A_{\text{stbeam}} \cdot F_y}{0.85 \cdot f_c \cdot b_{\text{beam}}}$$

$$a_{\text{beam}} = 0.36\text{in}$$

$$M_{\text{nbeam}} := A_{\text{stbeam}} \cdot F_y \cdot \left(d_{\text{beam}} - \frac{a_{\text{beam}}}{2} \right)$$

$$M_{\text{nbeam}} = 4.55\text{kip} \cdot \text{ft} \quad \dots \text{ say } 4.6\text{kip} \cdot \text{ft per foot of Rail Length}$$

$$F_v := \frac{18\text{kips}}{18\text{ft}} \quad F_v = 1 \frac{\text{kips}}{\text{ft}}$$

$$M_{\text{nbeamrequired}} := \frac{F_v \cdot 0.1\text{m}}{\text{ft}}$$

$$M_{\text{nbeamrequired}} = 0.5 \frac{\text{kips}}{\text{ft}}$$

<< M_{nbeam} Vertical Rail strength o.k. !!!!

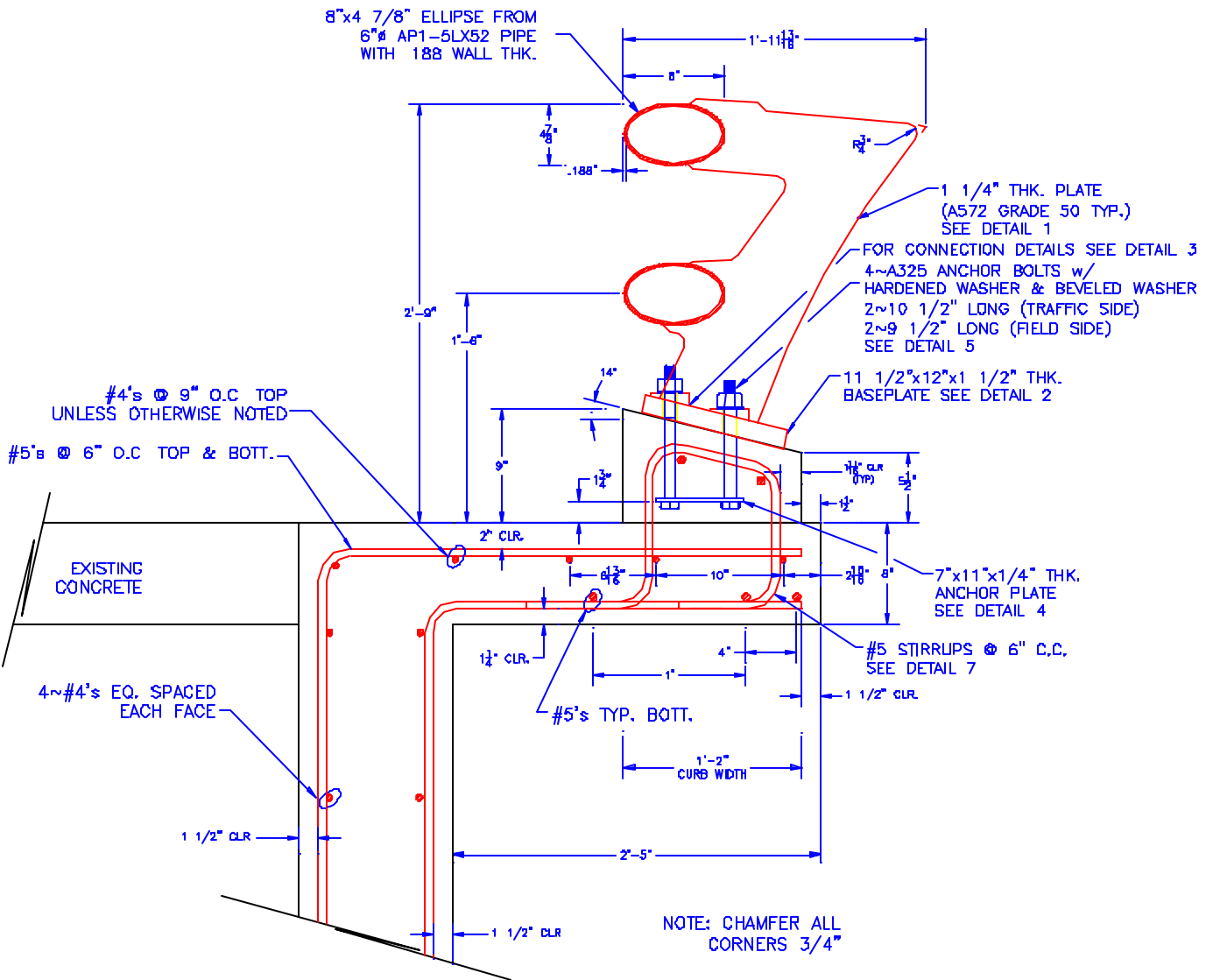
APPENDIX B. DESIGN CALCULATIONS FOR T77 BRIDGE RAIL

SUBJECT Texas Type T77 Aesthetic Bridge Rail BY: W. Williams

AASHTO LRFD Strength Analysis CKD: _____

CLIENT Texas Department of Transportation

- 1.) **Given:** 1.) The following T77 Aesthetic Steel Bridge Rail: Rev. 3
Find: Check Bridge Rail Design to Meet TL-4 Requirements w/ **8-ft Post Spacing:**



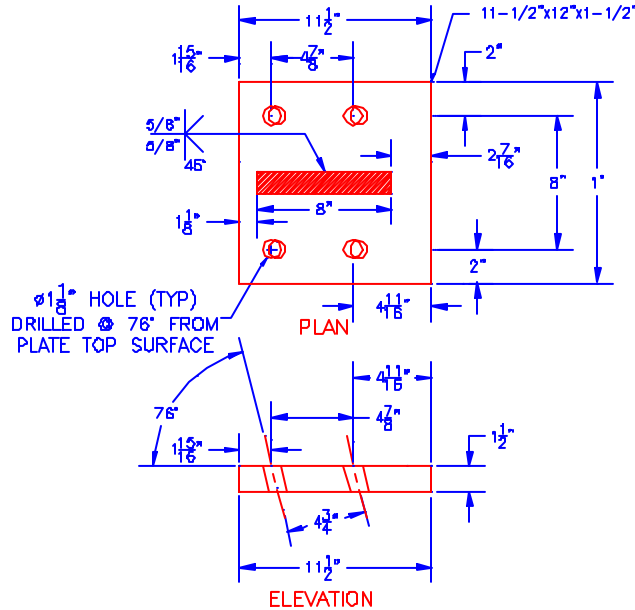
SUBJECT Texas Type T77 Aesthetic Bridge Rail

BY: W. Williams

AASHTO LRFD Strength Analysis

CKD: _____

CLIENT Texas Department of Transportation



2.) Given Input Data & Design Information:

***** AASHTO LRFD Bridge Design Specifications, Interim 2000, TL-3 Cond. *****

- $L_t := 4.0\text{ft}$ Longitudinal Length of Distribution of Impact Force (ft.), for TL-3 Conditions
- $F_t := 54\text{kips}$ Transverse Force specified in Table A13.2-1, TL-3 Conditions.
- $F_v := 4.5\text{kips}$ Vertical Force on Rail
- $L_L := 4.0\text{ft}$ Length of Longitudinal Force on Rail
- $L_v := 18\text{ft}$ Length of Vertical Force on Rail

***** Bridge Rail Properties *****

- L := 8ft** ... Post Spacing (ft.)
- Post_{thk} := 1.25in** Thickness of the post plate, inches **d_{post} := 8.0in** Width @ Post Base
- Baseplate_{Thk} := 1.25in** Thickness of Post Baseplate, inches
- F_ypost := 50ksi** Yield Strength of Post Plate Steel (ksi)

SUBJECT Texas Type T77 Aesthetic Bridge Rail BY: W. Williams
AASHTO LRFD Strength Analysis CKD: _____

CLIENT Texas Department of Transportation

***** Concrete & Reinforcing Steel Properties *****

$f'_c := 3600 \cdot \text{psi}$ Compressive Strength of Concrete (psi)
 $f_y := 60 \text{ksi}$ Yield Strength of Concrete Reinforcing Steel, (ksi)
 $\phi := 0.9$ Concrete Strength Reduction Factor

***** Anchor Bolt Properties *****

$\text{Dia}_{\text{bolt}} := \frac{7}{8} \cdot \text{in}$... Dia. of Anchor Bolts, (in.) $n_t := 2$ Number of Anchor Bolts in tension
 $n_s := 4$ Number of Anchor Bolts in Shear
 $\text{Area}_{\text{bolt}} := 0.25 \cdot \pi \cdot \text{Dia}_{\text{bolt}}^2$ $F_{uA325} := 120 \text{ksi}$.. Ten. Strength of A325 Bolt Mat., (ksi)

***** 6-inch Pipe Rail Properties *****

Pipe Choices: 1.) 6" Dia., A53 Grade "B" Pipe, Schedule 40 Pipe, wall thickness = 0.280"
 2.) 6" Dia. API-5LX52 Pipe, wall thickness = 0.188"

$t_{\text{wall}} := 0.188 \text{in}$ $\text{Rail}_{\text{vertOD}} := 4.875 \text{in}$ $\text{Rail}_{\text{horOD}} := 8 \text{in}$

$E_s := 29000 \text{ksi}$ $F_{y\text{rail}} := 52 \text{ksi}$

$f := 1.27$ Shape Factor for Tube Shape
 "Flexure of Beams" pg. 36

***** AutoCad & Risa Files & Misc. Information *****

File Locations:

- 1.) AutoCad File: T:\2001-2002\442882\T77\T77(Final)
- 2.) 3-Post Risa 3D Model: T77rev3-3Posts.r3d
- 3.) 1-Post Risa 3D Model for anchor bolt forces: T77rev3-1Post.r3d

SUBJECT Texas Type T77 Aesthetic Bridge Rail

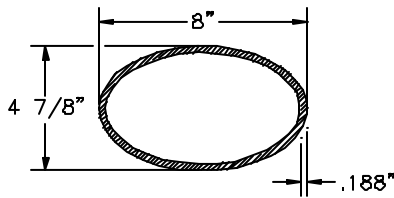
BY: W. Williams

AASHTO LRFD Strength Analysis

CKD: _____

CLIENT Texas Department of Transportation

3.) Calculate the Ultimate Moment Capacity of the Rail, "M_{p6in}":



Elliptical Rail Dimensions:

$$a := 4\text{in} \quad b := 4.875\text{in} \cdot 0.5$$

$$t_{\text{wall}} = 0.188\text{in}$$

$$I_{x1} := \pi \cdot a \cdot (b)^3 \cdot 0.25 \quad I_{x2} := \pi \cdot (a - t_{\text{wall}}) \cdot (b - t_{\text{wall}})^3 \cdot 0.25 \quad I_x := I_{x1} - I_{x2} \quad I_x = 11.42\text{in}^4$$

$$I_{y1} := \pi \cdot a^3 \cdot b \cdot 0.25 \quad I_{y2} := \pi \cdot (a - t_{\text{wall}})^3 \cdot (b - t_{\text{wall}}) \cdot 0.25 \quad I_y := I_{y1} - I_{y2} \quad I_y = 24.66\text{in}^4$$

$$S_{x\text{rail}} := \frac{I_x}{b} \quad S_{x\text{rail}} = 4.68\text{in}^3 \quad S_{y\text{rail}} := \frac{I_y}{a} \quad S_{y\text{rail}} = 6.16\text{in}^3$$

$$S_{y\text{rail}} = 6.16\text{in}^3 \quad Z_{y\text{rail}} := S_{y\text{rail}} \cdot f \quad Z_{y\text{rail}} = 7.83\text{in}^3$$

Plastic Sections Modulus
for Elliptical-Shaped Tube
Rail

Therefore:

$$M_{p6in} := F_{y\text{rail}} \cdot Z_{y\text{rail}} \quad \text{Ultimate Bending Capacity of 6-inch Pipe}$$

$$M_{p6in} = 33.92\text{ kips} \cdot \text{ft} \quad \text{..... each Rail}$$

$$J_o := \pi \cdot a \cdot b \cdot (a^2 + b^2) - \left[\pi \cdot (a - t_{\text{wall}}) \cdot (b - t_{\text{wall}}) \cdot \left[(a - t_{\text{wall}})^2 + (b - t_{\text{wall}})^2 \right] \right]$$

$$J_o = 144.29\text{in}^4$$

Check Bending from vertical 18-kip distributed load for TL-4..... assume simply supported ends over 10-ft span:

$$w := 1 \frac{\text{kips}}{\text{ft}} \quad l_v := 10\text{ft} \quad M_{\text{maxv}} := \frac{w \cdot (l_v)^2}{8} \quad M_{\text{maxv}} = 12.5\text{ kips} \cdot \text{ft}$$

$$SR_v := \frac{\left(\frac{M_{\text{maxv}}}{S_{x\text{rail}}} \right)}{F_{y\text{rail}}} \quad SR_v = 0.62 \quad \text{..... O.K.} < 1.0 \text{ !!!!!}$$

SUBJECT Texas Type T77 Aesthetic Bridge Rail
AASHTO LRFD Strength Analysis

BY: W. Williams
 CKD: _____

CLIENT Texas Department of Transportation

4.) Calculate the Plastic Strength of the Posts (P_{Post1}):

Calculate Plastic Section Modulus "Zx" (in³):

$d_{post} = 8 \text{ in}$ $Post_{thk} = 1.25 \text{ in}$ $F_{y_{post}} = 50 \text{ ksi}$

$Post_{plateHt} := 1 \text{ ft} + 11.0625 \text{ in} + Rail_{vertOD} \cdot 0.5$ $Post_{plateHt} = 2.12 \text{ ft}$

$H_{t_{pp}} := 1 \text{ ft} + 4.75 \text{ in} - Baseplate_{Thk}$ (Height of P_p from top of Baseplate center)

$$Z_{x_{post}} := \frac{Post_{thk} \cdot (d_{post})^2}{4}$$

$$Z_{x_{post}} = 20 \text{ in}^3$$

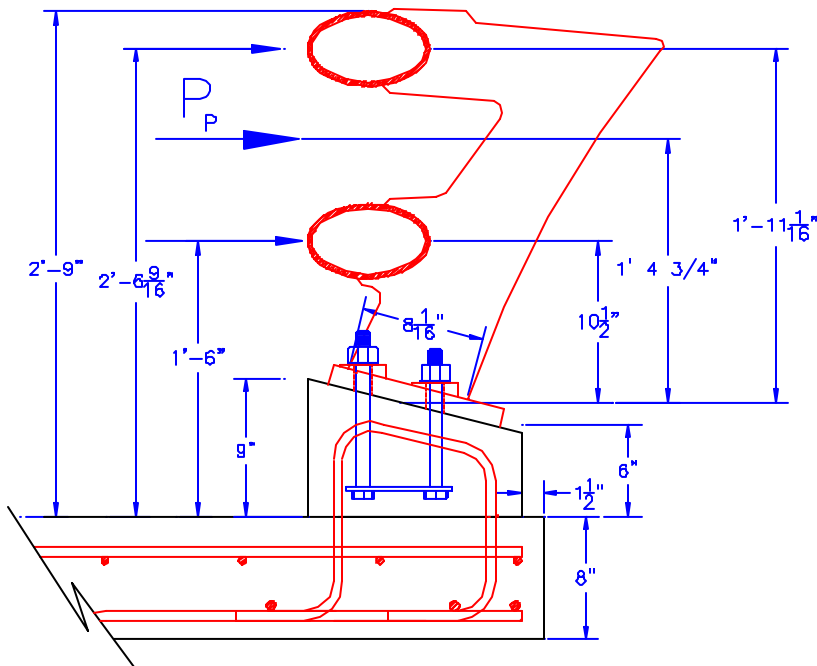
$$M_{post1} := Z_{x_{post}} \cdot F_{y_{post}}$$

$$M_{post1} = 83.33 \text{ kips} \cdot \text{ft}$$

$$P_{Post1} := \frac{M_{post1}}{H_{t_{pp}}}$$

$$P_{Post1} = 64.52 \text{ kips}$$

Ultimate Transverse Load
 Resistance of Single Post
 Base on Strength of Plate



However, from RISA-3D Analysis with combined stresses, ultimate plastic force appears to be near 54 kips.

Therefore: $P_{Post1} := 54 \text{ kips}$

SUBJECT Texas Type T77 Aesthetic Bridge Rail BY: W. Williams
AASHTO LRFD Strength Analysis CKD: _____
 CLIENT Texas Department of Transportation

5.) Calculate the Nominal Strengths of a bolt in Tension & Shear:

$$F_{uA325} = 120 \text{ ksi} \quad D_{ibolt} = 0.88 \text{ in} \quad A_{eabolt} = 0.6 \text{ in}^2$$

$$(0.75) \quad \phi_t := 1.0 \quad \phi_t R_{nt} := \phi_t \cdot F_{uA325} \cdot (0.75 \cdot A_{eabolt})$$

$$\phi_t R_{nt} = 54.12 \text{ kips}$$

$$\phi_v := 1.0 \quad (0.65 \text{ LRFD}) \quad m := 1 \quad \dots \text{ \# of shear planes per bolt}$$

$$\phi_v R_{nv} := \phi_v \cdot (0.60 \cdot F_{uA325}) \cdot m \cdot A_{eabolt}$$

$$\phi_v R_{nv} = 43.3 \text{ kips}$$

6.) Calculate the Post Strength @ Max. Bolt Strength (P_{Post2}) ~ Shear & Tension Forces in the bolts for Stress Ratio = 1.0 or slightly greater:

Ultimate Transverse Load
Resistance of Single Post
Based on Strength of
Tension Bolts

$$P_{Post2} := 54 \text{ kips}$$

Max. Shear Force
on Bolts
from RISA-3D

Tension Force
on Bolts
from Risa

$$R_{uv} := 19.1 \text{ kips}$$

$$R_{ut} := 55.725 \text{ kips}$$

$$\phi_t R_{nt} = 54.12 \text{ kips}$$

Ultimate Tension Strength of Bolts

$$\phi_v R_{nv} = 43.3 \text{ kips}$$

Ultimate Shear Strength of Bolts

$$\text{StressRatio} := \left(\frac{R_{ut}}{\phi_t R_{nt}} \right)^2 + \left(\frac{R_{uv}}{\phi_v R_{nv}} \right)^2$$

... Equation 4.14.1, Salmon & Johnson, 3rd Edition, pg. 173.

$$\text{StressRatio} = 1.25$$

o.k.... Use 7/8-in Dia. A325 Bolts

SUBJECT Texas Type T77 Aesthetic Bridge Rail BY: W. Williams
AASHTO LRFD Strength Analysis CKD: _____
 CLIENT Texas Department of Transportation

7.) Calculate the Punching Shear capacity from Post (P_{Post3}) (From Separate Risa Analysis):

$P_{Post3} := 27\text{kips}$

$\text{Force}_{Node338} := 6.733\text{kips}$ $\text{Bearing}_{area} := 1.66\text{in} \cdot (1\text{in})$

$\text{Punching}_{shear} := \frac{\text{Force}_{Node338}}{\text{Bearing}_{area}}$

$\text{Punching}_{shear} = 4.06\text{ ksi}$ probably acceptable !

Calculate Concrete Spring Constant (K/in): $A := 1.667\text{in} \cdot 1.0\text{in}$ $A = 1.67\text{in}^2$

$E_c := 57000 \cdot \sqrt{\frac{4000\text{psi}}{\text{psi}}} \cdot \text{psi}$ $E_c = 3604996.53\text{ psi}$ $L_{spring} := 7\text{in}$ $P := 1000\text{lb}$

$\Delta := \frac{P \cdot L_{spring}}{A \cdot E_c}$ $\Delta = 0.0001\text{ ft}$

$\frac{P}{A} = 0.6\text{ ksi}$ $K := \frac{P}{\Delta}$ $K = 858504.17 \frac{\text{lb}}{\text{in}}$ Say 850 kip/in!!

Calculate Anchor Bolt Spring Constant (K/in):

$E_s = 2.9 \times 10^7\text{ psi}$ $\text{Area}_{bolt} = 0.6\text{in}^2$ $L_{bolt} := 10\text{in}$ $P_{unitload} := 1000\text{lb}$

$\Delta_{bolt} := \frac{P \cdot L_{bolt}}{\text{Area}_{bolt} \cdot E_s}$ $\Delta_{bolt} = 0.00057\text{ in}$

$K := \frac{P_{unitload}}{\Delta_{bolt}}$ $K = 1743.8 \frac{\text{kips}}{\text{in}}$ Say 1700 kip/in!!

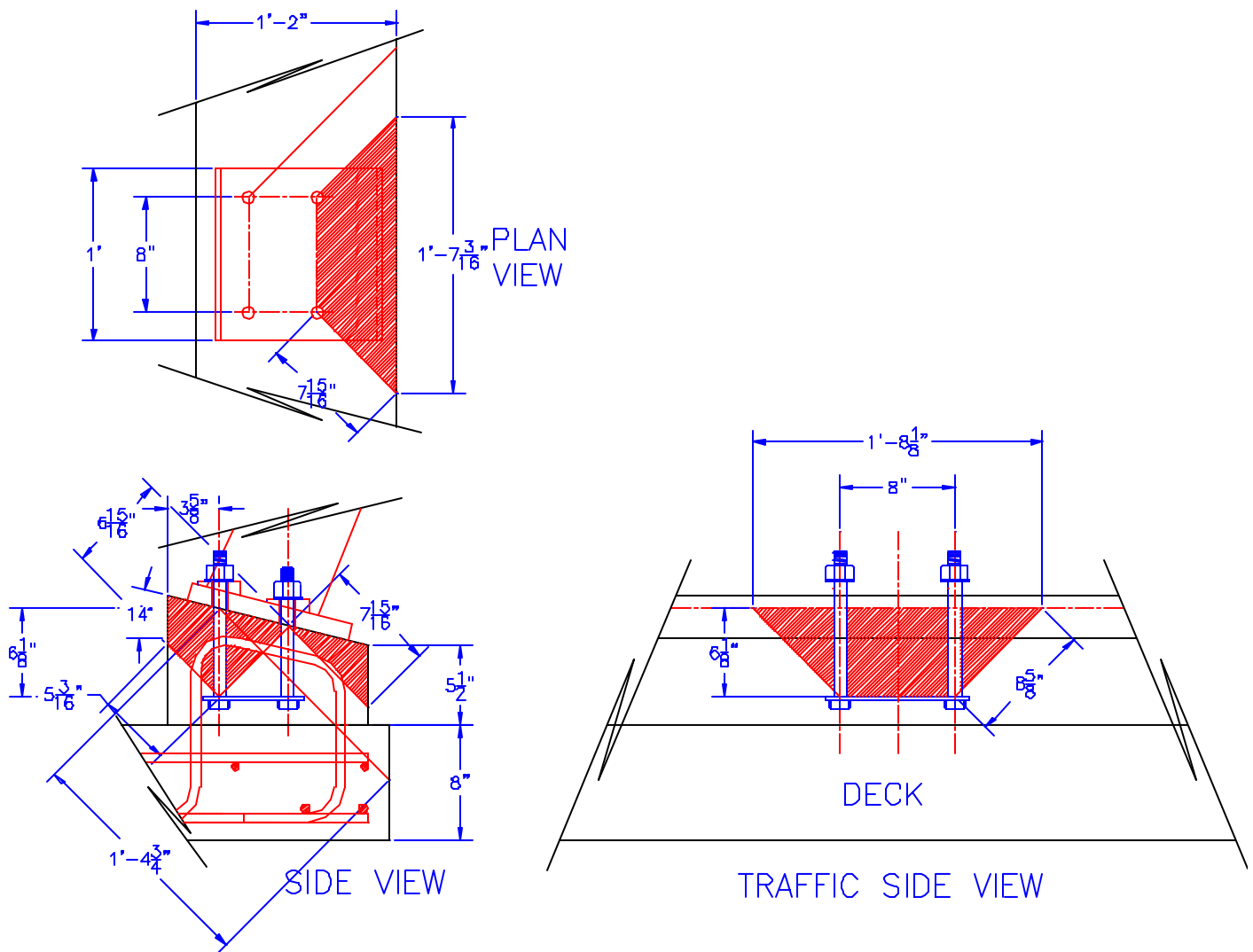
SUBJECT Texas Type T77 Aesthetic Bridge Rail
AASHTO LRFD Strength Analysis

BY: W. Williams
 CKD: _____

CLIENT Texas Department of Transportation

8.) Lateral Block Shear Failure Due to Bolt Shear (P_{Post4}):

Reference: Specification for the Design of Anchor Bolts (Rev. 0) S&B ES-3140
 From Figure 4 ~ "Shear Cone for Overlapping Cones"



SUBJECT Texas Type T77 Aesthetic Bridge Rail
AASHTO LRFD Strength Analysis

BY: W. Williams
 CKD: _____

CLIENT Texas Department of Transportation

Calculate the Block Shear Failure Area:

$$\text{Area}_1 := 7.9375\text{in} \cdot 8\text{in}$$

$$\text{Area}_2 := 7.9375\text{in} \cdot 7.9375\text{in}$$

$$A_{\text{sfc}} := \text{Area}_1 + \text{Area}_2 \quad A_{\text{sfc}} = 126.5\text{in}^2$$

$$\sigma_{\text{tension}} := 4 \cdot \sqrt{f'_c \cdot \text{psi}}$$

$$V_{\text{cr}} := \sigma_{\text{tension}} \cdot A_{\text{sfc}}$$

$$V_{\text{cr}} = 30.36 \text{ kips} \quad V_{\text{cr}} \text{ is for 2 bolts... force necessary to shear concrete in Side View above}$$

Therefore Force on Post to cause Block Shear failure =

$$P_{\text{Post4}} := 2 \cdot V_{\text{cr}}$$

This is the Shear on all 4 Bolts!

$$P_{\text{Post4}} = 60.72 \text{ kips}$$

Limited Strength of Post based on Shear failure of Concrete

SUBJECT Texas Type T77 Aesthetic Bridge Rail BY: W. Williams
AASHTO LRFD Strength Analysis CKD: _____
 CLIENT Texas Department of Transportation

9.) Calculate Post Strength Based on Anchor Bolt Pullout (P_{Post5}):

Based on the diagram above the pullout capacity of the two anchor bolts in tension is controlled by a 45 degree cone failure radiating from the head of the bolts upward. This area is one full circular cone (1/2 cone @ each end with rectangular side areas at 45 degrees between the bolts).

$L_c := 6.125in$ depth of the anchor bolts

$A_{tfc} := \pi \cdot (L_c)^2 \cdot 1.00$ Surface area of a circular cone at a depth of L_c with 10% reduction for limited side cover and surface slope. However, increase 10% for rebar.... therefore no reduction

$Area_3 := 5.1875in \cdot 8in$

$Area_4 := 6.9375in \cdot 8in$

$V_{rtension} := \sigma_{tension} \cdot (A_{tfc} + Area_3 + Area_4)$

$V_{rtension} = 51.57 kips$ This is the ultimate tension capacity of two tension bolts at bolt pullout

Return to Risa Model and determine the uniform loading on bolt rails to produce a combined tension on front two bolts of approx. 38 kips

From Risa-3D analysis for a single Post (T77rev3-1Post.r3d):

$P_{Post5} := 26kips$

SUBJECT Texas Type T77 Aesthetic Bridge Rail
AASHTO LRFD Strength Analysis

BY: W. Williams
 CKD: _____

CLIENT Texas Department of Transportation

**10.) Post Strength (P_{Post6}) Based on strength
 of Stirrups in Curb (#5 @ 6" O.C.):**

$$d_{curb} := 14.0in - 2in - .3125in$$

$$b_{curb} := 20.0in \quad \text{See Detail above for limits of cone Tension Failure}$$

With #5 @ 6" O.C max:

$$n_{bars} := \frac{b_{curb}}{6in} \quad n_{bars} = 3$$

$$A_{sstirrups} := n_{bars} \cdot 0.31in^2 \quad H_R := H_{tp} + Baseplate_{Thk} + 7.5in$$

$$f_y = 60 \text{ ksi} \quad a_{curb} := \frac{A_{sstirrups} \cdot f_y}{0.85 \cdot f_c \cdot b_{curb}} \quad A_{sstirrups} = 1.03 in^2$$

$$a_{curb} = 1.01 in \quad \phi_{curb} := 1.0$$

$$M_{ucurb} := \phi_{curb} \cdot A_{sstirrups} \cdot f_y \cdot \left(d_{curb} - \frac{a_{curb}}{2} \right)$$

$$M_{ucurb} = 57.77 \text{ kips} \cdot \text{ft} \quad H_R = 24.25 in$$

$$P_{Post6} := \frac{M_{ucurb}}{H_R} \quad P_{Post6} = 28.59 \text{ kips}$$

Limited Post Strength based on #5 Stirrups @ 6 inches on center.

SUBJECT Texas Type T77 Aesthetic Bridge Rail BY: W. Williams
AASHTO LRFD Strength Analysis CKD: _____
 CLIENT Texas Department of Transportation

11.) Determine Limiting Load Case on Posts (@ midpoint between rails where applic.):

- $P_{Post1} = 54 \text{ kips}$... Plastic Strength of Posts
- $P_{Post2} = 54 \text{ kips}$ Post Strength Due to Tension/Shear on Bolts
- $P_{Post3} = 27 \text{ kips}$ Post Strength Due to Punching Shear in Concrete from Post Baseplate
- $P_{Post4} = 60.72 \text{ kips}$ Post Strength due to max. Shear Force to cause shear failure in curb
- $P_{Post5} = 26 \text{ kips}$ Post Strength due to Anchor Bolt Tension Cone Failure in Concrete
- $P_{Post6} = 28.59 \text{ kips}$ Post Strength due to Curb reinforcing w/ #5 Stirrups @ 6" O.C.

Use P_{Post5} Strength as "worst case" in Analyses!

12.) Determine Total Rail Resistance of Rail for Single Span:

Post Spacing $L_t = 4 \text{ ft}$ $L = 8 \text{ ft}$

$P_{Post} := P_{Post5}$ Limiting Post Strength @ Baseplate

$P_{Post} = 26000 \text{ lb}$ $M_p := M_{p6in} \cdot 2$ $M_p = 67.84 \text{ kips} \cdot \text{ft}$

$N := 1$ Single Span Check

$$R_{1span} := \frac{16 \cdot M_p + (N - 1) \cdot (N + 1) \cdot P_{Post} \cdot L}{2 \cdot N \cdot L - L_t}$$

$R_{1span} = 90.46 \text{ kips}$

$P_{Post1} = 54 \text{ kips}$

$P_{Post2} = 54 \text{ kips}$

$P_{Post3} = 27 \text{ kips}$

$P_{Post4} = 60.72 \text{ kips}$

$P_{Post5} = 26 \text{ kips}$

13.) Determine Total Rail Resistance of Rail for Double Span:

$N := 2$ Double Span w/ Load applied @ Post

$M_p = 67.84 \text{ kips} \cdot \text{ft}$ $P_{Post} = 26 \text{ kips}$ $L = 8 \text{ ft}$

$$R_{2span} := \frac{16 \cdot M_p + N^2 \cdot P_{Post} \cdot L}{2 \cdot N \cdot L - L_t}$$

$R_{2span} = 68.48 \text{ kips}$

SUBJECT Texas Type T77 Aesthetic Bridge Rail BY: W. Williams
AASHTO LRFD Strength Analysis CKD: _____
 CLIENT Texas Department of Transportation

14.) Determine Total Rail Resistance of Rail for Triple Span:

$M_p = 67.84 \text{ kips} \cdot \text{ft}$ $P_{Post} = 26 \text{ kips}$ Limiting Post Strength @ Baseplate

$N := 3$ Three Span Check

$$R_{3span} := \frac{16 \cdot M_p + (N - 1) \cdot (N + 1) \cdot P_{Post} \cdot L}{2 \cdot N \cdot L - L_t}$$

$R_{3span} = 62.49 \text{ kips}$

Therefore worst case is three Span Condition

15.) Determine Total Rail Resistance of Rail for Quad Span:

$N := 4$ Double Span w/ Load applied @ Post

$M_p = 67.84 \text{ kips} \cdot \text{ft}$ $P_{Post} = 26 \text{ kips}$ $L = 8 \text{ ft}$

$$R_{2span} := \frac{16 \cdot M_p + N^2 \cdot P_{Post} \cdot L}{2 \cdot N \cdot L - L_t}$$

$R_{2span} = 73.56 \text{ kips}$

SUBJECT Texas Type T77 Aesthetic Bridge Rail BY: W. Williams
AASHTO LRFD Strength Analysis CKD: _____
 CLIENT Texas Department of Transportation

16.) Determine Total Rail Resistance at the Resultant Heights of 27 & 32 inches:

$H_R = 24.25 \text{ in}$ Height from pavement surface to midpoint between rails (in.)

***** Resultant @ 27-inch Height ***** ***** Resultant @ 32-inch Height *****

$$H_{27} := 27 \text{ in}$$

$$H_{32} := 32 \text{ in}$$

$$R_{\text{bar}27} := \frac{R_{3\text{span}} \cdot H_R}{H_{27}}$$

$$R_{\text{bar}32} := \frac{R_{3\text{span}} \cdot H_R}{H_{32}}$$

$$R_{\text{bar}27} = 56.12 \text{ kips}$$

$$R_{\text{bar}32} = 47.35 \text{ kips}$$

17.) Check Post Strength & Deflection w/ Longitudinal & Transverse Forces:

From the Mesh for a RISA-3D
 Plate Model:

18.0-kips Longitudinal Load over 2 rails
& 54 kips Transverse Load over 2 rails

- 1.) Max. Long. Translation approx. 0.25 inch & max. transverse translation approx. 0.5 inch.
- 2.) Max Von Mises Stress in Plate approx. 60 ksi. Therefore use 1.25-inch Thk. Plate for Post ... o.k.!

In Summary: The TxDOT "T77" Rail meets the requirements for TL-3 Loading Conditions w/ 8-ft post spacing.

APPENDIX C. CRASH TEST PROCEDURES AND DATA ANALYSIS

The crash test and data analysis procedures were in accordance with guidelines presented in *NCHRP Report 350*. Brief descriptions of these procedures are presented as follows.

ELECTRONIC INSTRUMENTATION AND DATA PROCESSING

The test vehicle was instrumented with three solid-state angular rate transducers to measure roll, pitch, and yaw rates; a triaxial accelerometer near the vehicle center of gravity (c.g.) to measure longitudinal, lateral, and vertical acceleration levels; and a back-up biaxial accelerometer in the rear of the vehicle to measure longitudinal and lateral acceleration levels. These accelerometers were ENDEVCO® Model 2262CA, piezoresistive accelerometers with a ± 100 g range.

The accelerometers are strain gage type with a linear millivolt output proportional to acceleration. Angular rate transducers are solid state, gas flow units designed for high-“g” service. Signal conditioners and amplifiers in the test vehicle increase the low-level signals to a ± 2.5 volt maximum level. The signal conditioners also provide the capability of an R-cal (resistive calibration) or shunt calibration for the accelerometers and a precision voltage calibration for the rate transducers. The electronic signals from the accelerometers and rate transducers are transmitted to a base station by means of a 15-channel, constant-bandwidth, Inter-Range Instrumentation Group (IRIG), FM/FM telemetry link for recording on magnetic tape and for display on a real-time strip chart. Calibration signals from the test vehicle are recorded before the test and immediately afterwards. A crystal-controlled time reference signal is simultaneously recorded with the data. Wooden dowels actuate pressure-sensitive switches on the bumper of the impacting vehicle prior to impact by wooden dowels to indicate the elapsed time over a known distance to provide a measurement of impact velocity. The initial contact also produces an “event” mark on the data record to establish the instant of contact with the installation.

The multiplex of data channels, transmitted on one radio frequency, is received and demultiplexed onto separate tracks of a 28 track, IRIG tape recorder. After the test, the data are played back from the tape machine and digitized. A proprietary software program (WinDigit) converts the analog data from each transducer into engineering units using the R-cal and pre-zero values at 10,000 samples per second per channel. WinDigit also provides SAE J211 class 180 phaseless digital filtering and vehicle impact velocity.

All accelerometers are calibrated annually according to Society of Automotive Engineers (SAE) J211 4.6.1 by means of an ENDEVCO® 2901, precision primary vibration standard. This device and its support instruments are returned to the factory annually for a National Institute of Standards Technology (NIST) traceable calibration. The subsystems of each data channel are also evaluated annually, using instruments with current NIST traceability, and the results are factored into the accuracy of the total data channel, per SAE J211. Calibrations and evaluations are made any time data are suspect.

The Test Risk Assessment Program (TRAP) uses the data from WinDigit to compute occupant/compartiment impact velocities, time of occupant/compartiment impact after vehicle impact, and the highest 10-ms average ridedown acceleration. WinDigit calculates change in vehicle velocity at the end of a given impulse period. In addition, maximum average accelerations over 50-ms intervals in each of the three directions are computed. For reporting purposes, the data from the vehicle-mounted accelerometers are filtered with a 60-Hz digital filter, and acceleration versus time curves for the longitudinal, lateral, and vertical directions are plotted using TRAP. TRAP uses the data from the yaw, pitch, and roll rate transducers to compute angular displacement in degrees at 0.0001-s intervals and then plots: yaw, pitch, and roll versus time. These displacements are in reference to the vehicle-fixed coordinate system with the initial position and orientation of the vehicle-fixed coordinate systems being initial impact.

ANTHROPOMORPHIC DUMMY INSTRUMENTATION

An Alderson Research Laboratories Hybrid II, 50th percentile male anthropomorphic dummy, restrained with lap and shoulder belts, was placed in the driver's position of the 820C vehicle. The dummy was uninstrumented. Use of a dummy in the 2000P vehicle is optional according to *NCHRP Report 350* and there was no dummy used in the tests with the 2000P vehicle.

PHOTOGRAPHIC INSTRUMENTATION AND DATA PROCESSING

Photographic coverage of the test included three high-speed cameras: one overhead with a field of view perpendicular to the ground and directly over the impact point; one placed behind the installation at an angle; and a third placed to have a field of view parallel to and aligned with the installation at the downstream end. A flashbulb activated by pressure-sensitive tape switches was positioned on the impacting vehicle to indicate the instant of contact with the installation and was visible from each camera. The films from these high-speed cameras were analyzed on a computer-linked motion analyzer to observe phenomena occurring during the collision and to obtain time-event, displacement, and angular data. A BetaCam, a VHS-format video camera and recorder, and still cameras were used to record and document conditions of the test vehicle and installation before and after the test.

TEST VEHICLE PROPULSION AND GUIDANCE

The test vehicle was towed into the test installation using a steel cable guidance and reverse tow system. A steel cable for guiding the test vehicle was tensioned along the path, anchored at each end, and threaded through an attachment to the front wheel of the test vehicle. An additional steel cable was connected to the test vehicle, passed around a pulley near the impact point, through a pulley on the tow vehicle, and then anchored to the ground such that the tow vehicle moved away from the test site. A two-to-one speed ratio between the test and tow vehicle existed with this system. Just prior to impact with the installation, the test vehicle was

released to be free-wheeling and unrestrained. The vehicle remained free-wheeling, i.e., no steering or braking inputs, until the vehicle cleared the immediate area of the test site, at which time brakes on the vehicle were activated to bring it to a safe and controlled stop.

APPENDIX D. TEST VEHICLE PROPERTIES AND INFORMATION

DATE: 05/06/02 TEST NO.: 442882-1 VIN NO.: 1GCGC24R2VZ114725
 YEAR: 1997 MAKE: Chevrolet MODEL: 2500 Pickup
 TIRE INFLATION PRESSURE: _____ ODOMETER: 183218 TIRE SIZE: LT 245/75 R16

MASS DISTRIBUTION (kg) LF 590 RF 560 LR 436 RR 458

DESCRIBE ANY DAMAGE TO VEHICLE PRIOR TO TEST:

● Denotes accelerometer location.
 NOTES: _____

ENGINE TYPE: 8 CYL
 ENGINE CID: 5.7 L
 TRANSMISSION TYPE:
 _____ AUTO
 MANUAL

OPTIONAL EQUIPMENT:
8 LUGS

DUMMY DATA:
 TYPE: _____
 MASS: _____
 SEAT POSITION: _____

GEOMETRY - (mm)

A	<u>1860</u>	E	<u>1330</u>	J	<u>1120</u>	N	<u>1595</u>	R	<u>710</u>
B	<u>870</u>	F	<u>5550</u>	K	<u>680</u>	O	<u>1625</u>	S	<u>900</u>
C	<u>3350</u>	G	<u>1497.5</u>	L	<u>80</u>	P	<u>750</u>	T	<u>1440</u>
D	<u>1820</u>	H	_____	M	<u>460</u>	Q	<u>445</u>	U	<u>3410</u>

MASS - (kg)	CURB	TEST INERTIAL	GROSS STATIC
M ₁	<u>1244</u>	<u>1150</u>	_____
M ₂	<u>926</u>	<u>894</u>	_____
M _T	<u>2170</u>	<u>2044</u>	_____

Figure 34. Vehicle Properties for Test 442882-1.

Table 5. Exterior Crush Measurements for Test 442882-1.

VEHICLE CRUSH MEASUREMENT SHEET¹

Complete When Applicable	
End Damage	Side Damage
Undeformed end width _____ Corner shift: A1 _____ A2 _____ End shift at frame (CDC) (check one) < 4 inches _____ ≥ 4 inches _____	Bowing: B1 _____ X1 _____ B2 _____ X2 _____ Bowing constant $\frac{X1 + X2}{2} \text{ in}$

Note: Measure C₁ to C₆ from Driver to Passenger side in Front or Rear Impacts – Rear to Front in Side Impacts.

Specific Impact Number	Plane* of C-Measurements	Direct Damage		Field L**	C ₁	C ₂	C ₃	C ₄	C ₅	C ₆	±D
		Width** (CDC)	Max*** Crush								
1	Front bumper	1000	650	1500	+80	+40	-100	-230	-400	-650	0
2	1000 above ground	1000	530	-1400	-120	-230	-300	-390	-450	-530	+1420

¹Table taken from National Accident Sampling System (NASS).

*Identify the plane at which the C-measurements are taken (e.g., at bumper, above bumper, at sill, above sill, at beltline, etc.) or label adjustments (e.g., free space).

Free space value is defined as the distance between the baseline and the original body contour taken at the individual C locations. This may include the following: bumper lead, bumper taper, side protrusion, side taper, etc. Record the value for each C-measurement and maximum crush.

**Measure and document on the vehicle diagram the beginning or end of the direct damage width and field L (e.g., side damage with respect to undamaged axle).

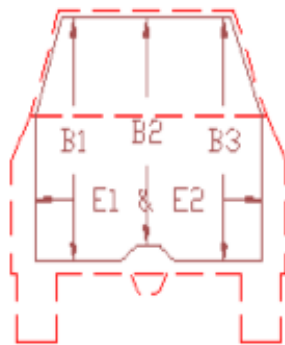
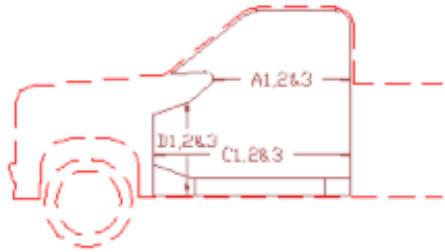
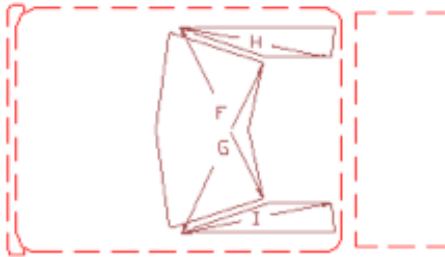
***Measure and document on the vehicle diagram the location of the maximum crush.

Note: Use as many lines/columns as necessary to describe each damage profile.

Table 6. Occupant Compartment Measurements for Test 442882-1.

Truck

Occupant Compartment Deformation



	BEFORE	AFTER
A1	870	884
A2	942	855
A3	936	824
B1	1080	1066
B2	1035	1205
B3	1084	1270
C1	1375	1376
C2	510	426
C3	1370	1195
D1	323	385
D2	165	136
D3	310	428
E1	1592	1575
E2	1593	1620
F	1475	1415
G	1475	1484
H	1100	890
I	1100	1100
J	1525	1440

DATE: 07/18/02 TEST NO.: 442882-2 VIN NO.: 1GCGC24R7WE167607
 YEAR: 1998 MAKE: Chevrolet MODEL: 2500 Pickup
 TIRE INFLATION PRESSURE: _____ ODOMETER: 156913 TIRE SIZE: 245 75 R16

MASS DISTRIBUTION (kg) LF 596 RF 586 LR 419 RR 451

DESCRIBE ANY DAMAGE TO VEHICLE PRIOR TO TEST:

● Denotes accelerometer location.
 NOTES: _____

ENGINE TYPE: 8 CYL
 ENGINE CID: 5.7 L
 TRANSMISSION TYPE:
 AUTO
 MANUAL

OPTIONAL EQUIPMENT:
8 LUGS

DUMMY DATA:
 TYPE: _____
 MASS: _____
 SEAT POSITION: _____

GEOMETRY - (mm)

A	<u>1860</u>	E	<u>1330</u>	J	<u>1062</u>	N	<u>1585</u>	R	<u>730</u>
B	<u>830</u>	F	<u>5515</u>	K	<u>645</u>	O	<u>1620</u>	S	<u>908</u>
C	<u>3355</u>	G	<u>1422.4</u>	L	<u>90</u>	P	<u>750</u>	T	<u>1470</u>
D	<u>1834</u>	H	_____	M	<u>360</u>	Q	<u>444</u>	U	<u>3380</u>

MASS - (kg)	CURB	TEST INERTIAL	GROSS STATIC
M ₁	<u>1212</u>	<u>1182</u>	_____
M ₂	<u>863</u>	<u>870</u>	_____
M _T	<u>2075</u>	<u>2052</u>	_____

Figure 35. Vehicle Properties for Test 442882-2.

Table 7. Exterior Crush Measurements for Test 442882-2.

VEHICLE CRUSH MEASUREMENT SHEET¹

Complete When Applicable	
End Damage	Side Damage
Undeformed end width _____ Corner shift: A1 _____ A2 _____ End shift at frame (CDC) (check one) < 4 inches _____ ≥ 4 inches _____	Bowing: B1 _____ X1 _____ B2 _____ X2 _____ Bowing constant $\frac{X1 + X2}{2} \text{ in}$

Note: Measure C₁ to C₆ from Driver to Passenger side in Front or Rear Impacts – Rear to Front in Side Impacts.

Specific Impact Number	Plane* of C-Measurements	Direct Damage		Field L**	C ₁	C ₂	C ₃	C ₄	C ₅	C ₆	±D
		Width** (CDC)	Max*** Crush								
1	Left front bumper	570	550	600	550	440	300	150	90	20	-290
2	810 mm above ground	860	670	1650	670	540	400	280	180	110	+1520

¹Table taken from National Accident Sampling System (NASS).

*Identify the plane at which the C-measurements are taken (e.g., at bumper, above bumper, at sill, above sill, at beltline, etc.) or label adjustments (e.g., free space).

Free space value is defined as the distance between the baseline and the original body contour taken at the individual C locations. This may include the following: bumper lead, bumper taper, side protrusion, side taper, etc. Record the value for each C-measurement and maximum crush.

**Measure and document on the vehicle diagram the beginning or end of the direct damage width and field L (e.g., side damage with respect to undamaged axle).

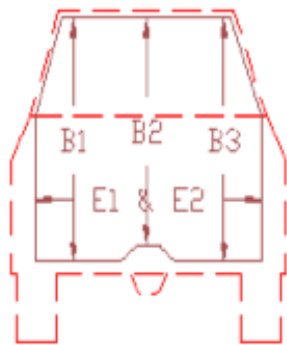
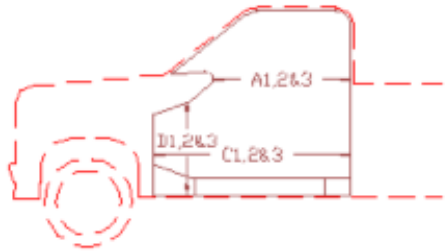
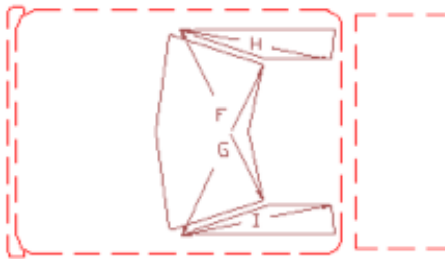
***Measure and document on the vehicle diagram the location of the maximum crush.

Note: Use as many lines/columns as necessary to describe each damage profile.

Table 8. Occupant Compartment Measurements for Test 442882-2.

T r u c k

O c c u p a n t C o m p a r t m e n t D e f o r m a t i o n



	BEFORE	AFTER
A1	915	797
A2	930	910
A3	910	940
B1	1100	1119
B2	1015	1047
B3	1123	1103
C1	1385	1313
C2	1275	1185
C3	1394	1395
D1	316	347
D2	333	335
D3	325	338
E1	1595	1564
E2	1602	1644
F	1540	1560
G	1540	1495
H	790	795
I	790	735
J	1520	1455
K	1680	1575

DATE: 08/23/02 TEST NO.: 442882-3 VIN NO.: 1GCGC24R1VZ175094
 YEAR: 1997 MAKE: Chevrolet MODEL: 2500 Pickup
 TIRE INFLATION PRESSURE: _____ ODOMETER: 187581 TIRE SIZE: 245 75 R16

MASS DISTRIBUTION (kg) LF 600 RF 574 LR 421 RR 448

DESCRIBE ANY DAMAGE TO VEHICLE PRIOR TO TEST:

● Denotes accelerometer location.
 NOTES: _____

ENGINE TYPE: 8 CYL
 ENGINE CID: 5.7 L
 TRANSMISSION TYPE:
 AUTO
 MANUAL

OPTIONAL EQUIPMENT:
8 LUGS

DUMMY DATA:
 TYPE: _____
 MASS: _____
 SEAT POSITION: _____

GEOMETRY - (mm)

A	<u>1860</u>	E	<u>1325</u>	J	<u>1070</u>	N	<u>1585</u>	R	<u>730</u>
B	<u>830</u>	F	<u>5505</u>	K	<u>650</u>	O	<u>1620</u>	S	<u>910</u>
C	<u>3350</u>	G	<u>1424.9</u>	L	<u>90</u>	P	<u>740</u>	T	<u>1460</u>
D	<u>1820</u>	H	_____	M	<u>365</u>	Q	<u>445</u>	U	<u>3385</u>

MASS - (kg)	CURB	TEST INERTIAL	GROSS STATIC
M ₁	<u>1209</u>	<u>1174</u>	_____
M ₂	<u>936</u>	<u>869</u>	_____
M _T	<u>2145</u>	<u>2043</u>	_____

Figure 36. Vehicle Properties for Test 442882-3.

Table 9. Exterior Crush Measurements for Test 442882-3.

VEHICLE CRUSH MEASUREMENT SHEET¹

Complete When Applicable	
End Damage	Side Damage
Undeformed end width _____ Corner shift: A1 _____ A2 _____ End shift at frame (CDC) (check one) < 4 inches _____ ≥ 4 inches _____	Bowing: B1 _____ X1 _____ B2 _____ X2 _____ Bowing constant $\frac{X1 + X2}{2} \text{ in}$

Note: Measure C₁ to C₆ from Driver to Passenger side in Front or Rear Impacts – Rear to Front in Side Impacts.

Specific Impact Number	Plane* of C-Measurements	Direct Damage		Field L**	C ₁	C ₂	C ₃	C ₄	C ₅	C ₆	±D
		Width** (CDC)	Max*** Crush								
1	Front bumper	450	780	1800	20	40	75	210	380	780	0
2	650 mm above ground	380	420	2640	420	N/A	100	80	75	60	+800

¹Table taken from National Accident Sampling System (NASS).

*Identify the plane at which the C-measurements are taken (e.g., at bumper, above bumper, at sill, above sill, at beltline, etc.) or label adjustments (e.g., free space).

Free space value is defined as the distance between the baseline and the original body contour taken at the individual C locations. This may include the following: bumper lead, bumper taper, side protrusion, side taper, etc. Record the value for each C-measurement and maximum crush.

**Measure and document on the vehicle diagram the beginning or end of the direct damage width and field L (e.g., side damage with respect to undamaged axle).

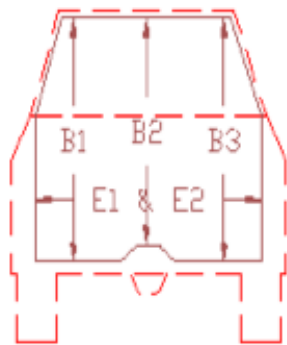
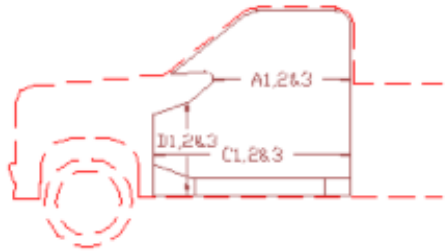
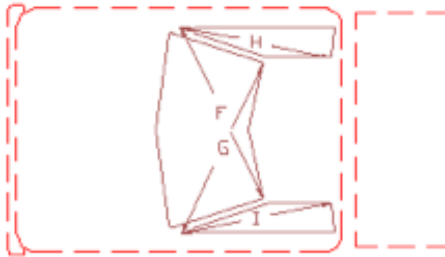
***Measure and document on the vehicle diagram the location of the maximum crush.

Note: Use as many lines/columns as necessary to describe each damage profile.

Table 10. Occupant Compartment Measurements for Test 442882-3.

Truck

Occupant Compartment Deformation

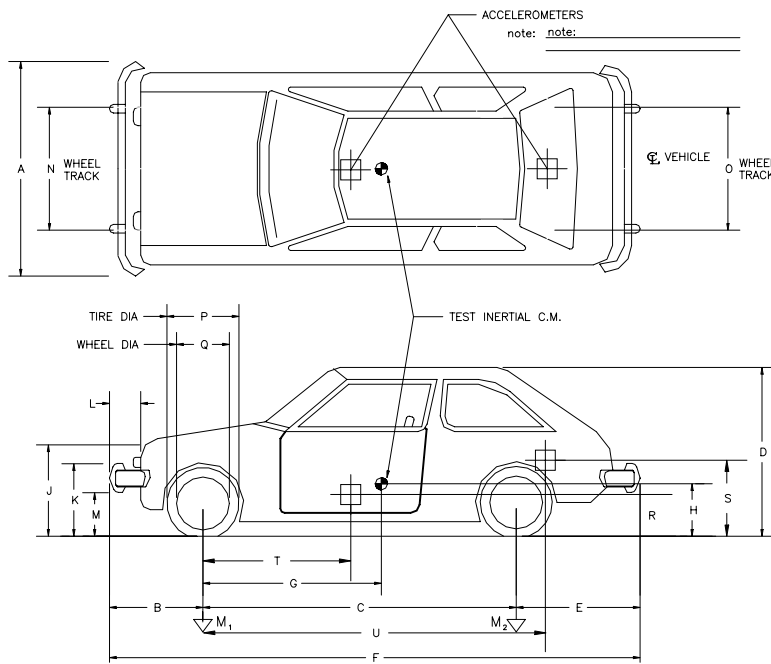


	BEFORE	AFTER
A1	910	920
A2	926	935
A3	920	913
B1	1072	1071
B2	998	999
B3	1082	1109
C1	1384	1388
C2	1263	1230
C3	1390	1250
C4	1370	1160
D1	320	330
D2	341	362
D3	313	429
E1	1597	1622
E2	1593	1657
F	1460	1459
G	1460	1445
H	900	860
I	900	890
J	1523	1425
K	1662	1440

DATE: 08/27/02 TEST NO.: 442882-4 VIN NO.: 2C1MR2261V6721671
 YEAR: 1997 MAKE: Geo MODEL: Metro
 TIRE INFLATION PRESSURE: _____ ODOMETER: 104901 TIRE SIZE: P155 80R13

MASS DISTRIBUTION (kg) LF 256 RF 250 LR 157 RR 157

DESCRIBE ANY DAMAGE TO VEHICLE PRIOR TO TEST:



ENGINE TYPE: 3 CYL

ENGINE CID: 1.0 L

TRANSMISSION TYPE:

AUTO

MANUAL

OPTIONAL EQUIPMENT:

DUMMY DATA:

TYPE: 50th percentile male

MASS: 77 kg

SEAT POSITION: driver

GEOMETRY - (mm)

A	<u>1450</u>	E	<u>560</u>	J	<u>610</u>	N	<u>1380</u>	R	<u>400</u>
B	<u>790</u>	F	<u>371</u>	K	<u>525</u>	O	<u>1365</u>	S	<u>550</u>
C	<u>2365</u>	G	<u>905.6</u>	L	<u>160</u>	P	<u>570</u>	T	<u>960</u>
D	<u>1400</u>	H	_____	M	<u>400</u>	Q	<u>365</u>	U	<u>2400</u>

MASS - (kg)	CURB	TEST INERTIAL	GROSS STATIC
M ₁	<u>500</u>	<u>506</u>	<u>544</u>
M ₂	<u>314</u>	<u>314</u>	<u>353</u>
M _T	<u>814</u>	<u>820</u>	<u>897</u>

Figure 37. Vehicle Properties for Test 442882-4.

Table 11. Exterior Crush Measurements for Test 442882-4.

VEHICLE CRUSH MEASUREMENT SHEET¹

Complete When Applicable	
End Damage	Side Damage
Undeformed end width _____ Corner shift: A1 _____ A2 _____ End shift at frame (CDC) (check one) < 4 inches _____ ≥ 4 inches _____	Bowing: B1 _____ X1 _____ B2 _____ X2 _____ Bowing constant $\frac{X1 + X2}{2} \text{ in}$

Note: Measure C₁ to C₆ from Driver to Passenger side in Front or Rear Impacts – Rear to Front in Side Impacts.

Specific Impact Number	Plane* of C-Measurements	Direct Damage		Field L**	C ₁	C ₂	C ₃	C ₄	C ₅	C ₆	±D
		Width** (CDC)	Max*** Crush								
1	Front bumper	660	120	650	120	80	60	40	20	0	-325
2	Front bumper	660	230	1200	+35	40	35	40	130	230	+1255

¹Table taken from National Accident Sampling System (NASS).

*Identify the plane at which the C-measurements are taken (e.g., at bumper, above bumper, at sill, above sill, at beltline, etc.) or label adjustments (e.g., free space).

Free space value is defined as the distance between the baseline and the original body contour taken at the individual C locations. This may include the following: bumper lead, bumper taper, side protrusion, side taper, etc. Record the value for each C-measurement and maximum crush.

**Measure and document on the vehicle diagram the beginning or end of the direct damage width and field L (e.g., side damage with respect to undamaged axle).

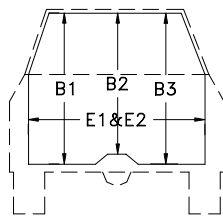
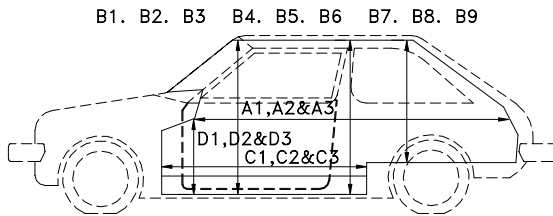
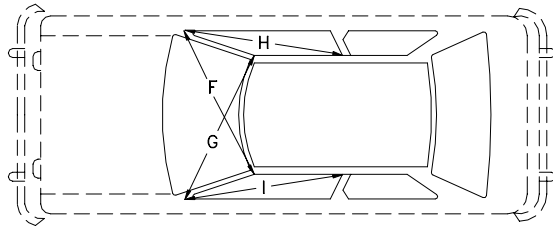
***Measure and document on the vehicle diagram the location of the maximum crush.

Note: Use as many lines/columns as necessary to describe each damage profile.

Table 12. Occupant Compartment Measurements for Test 442882-4.

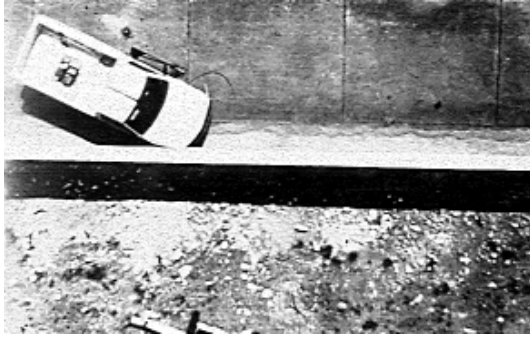
Small Car

Occupant Compartment Deformation

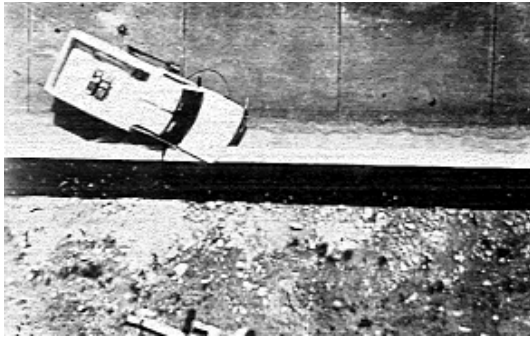


	BEFORE	AFTER
A1	1417	1412
A2	1995	2008
A3	1405	1405
B1	962	970
B2	900	891
B3	965	965
B4	921	921
B5	901	901
B6	925	925
B7		
B8		
B9		
C1	570	545
C2	704	714
C3	563	563
D1	270	275
D2	100	97
D3	238	240
E1	1218	1272
E2	1175	1255
F	1211	1211
G	1211	1205
H	1100	1095
I	1100	1100
J	1195	1170

APPENDIX E. SEQUENTIAL PHOTOGRAPHS



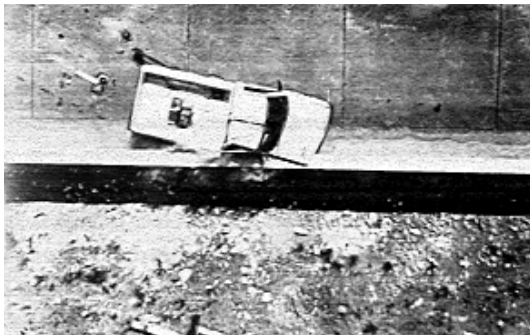
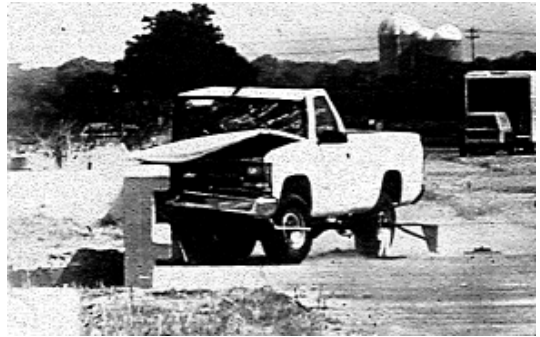
0.000 s



0.044 s



0.088 s



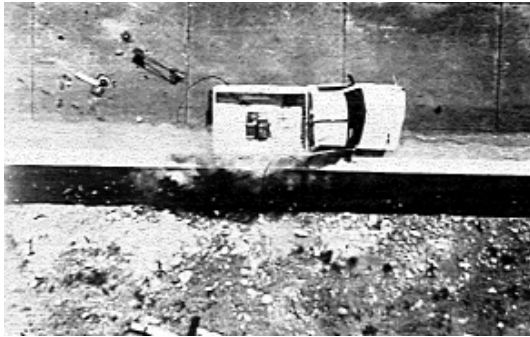
0.154 s



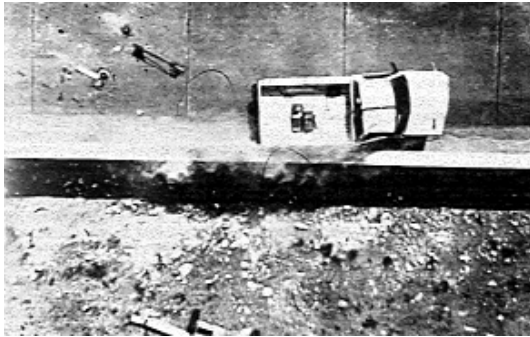
Figure 38. Sequential Photographs for Test 442882-1 (Overhead and Frontal Views).



0.220 s



0.263 s



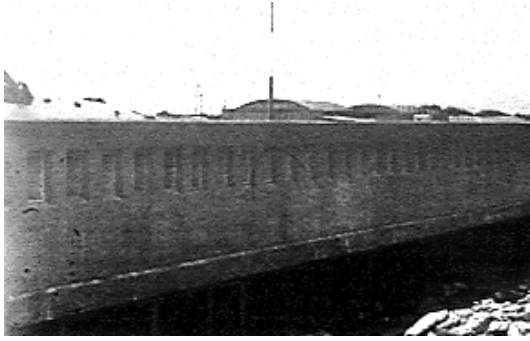
0.329 s



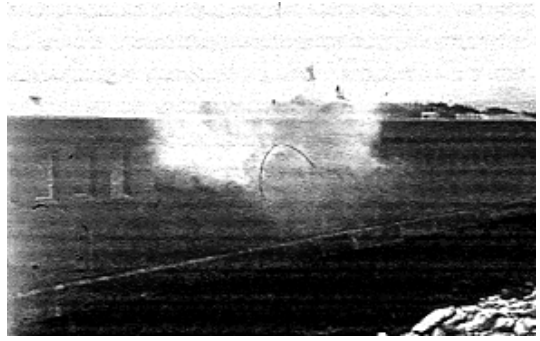
0.395 s



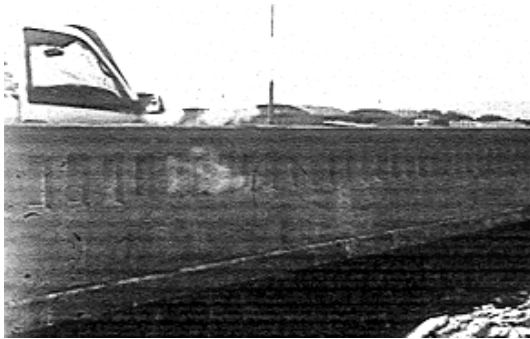
**Figure 38. Sequential Photographs for Test 442882-1
(Overhead and Frontal Views) (continued).**



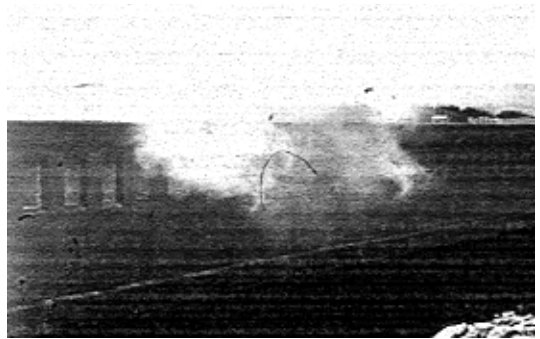
0.000 s



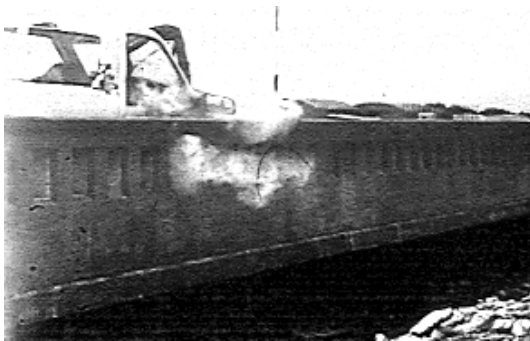
0.220 s



0.044 s



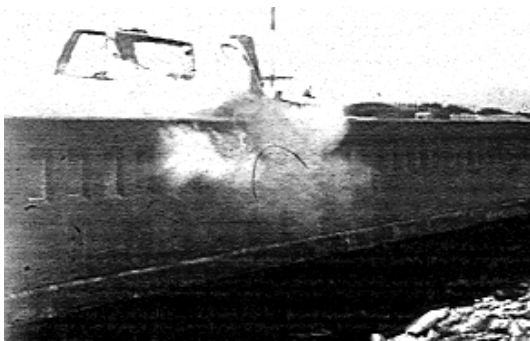
0.263 s



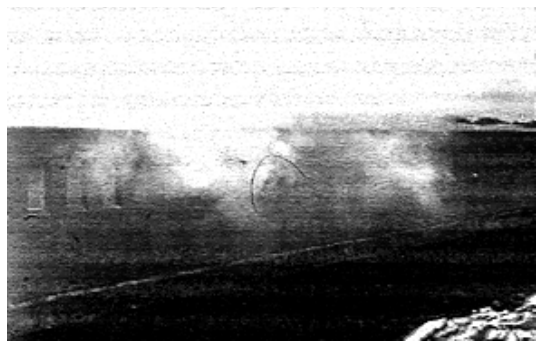
0.088 s



0.329 s

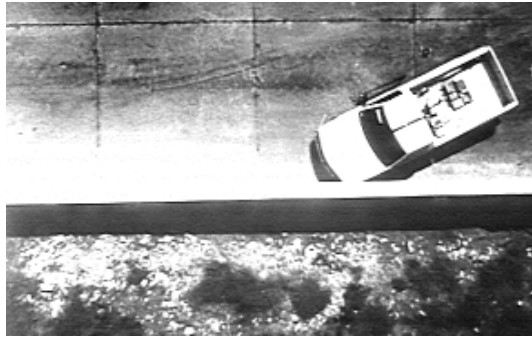


0.154 s

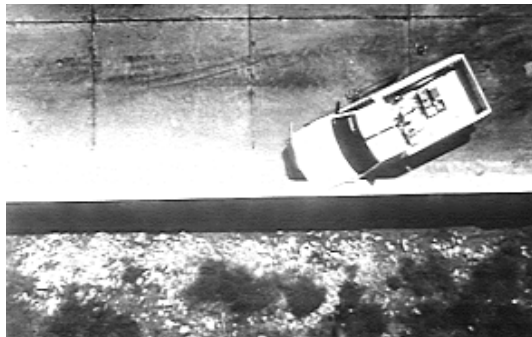


0.395 s

Figure 39. Sequential Photographs for Test 442882-1 (Rear View).



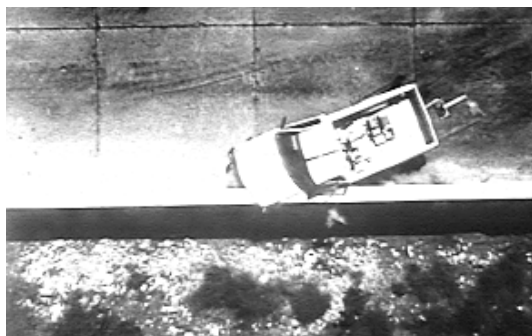
0.000 s



0.024 s



0.047 s



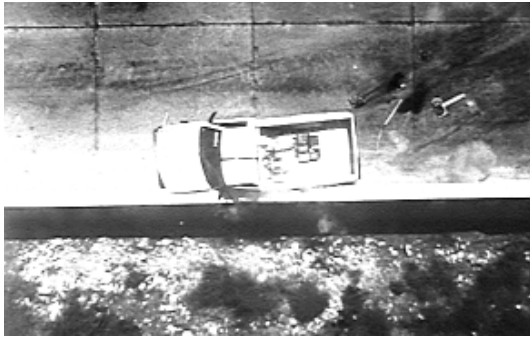
0.095 s



Figure 40. Sequential Photographs for Test 442882-2 (Overhead and Frontal Views).



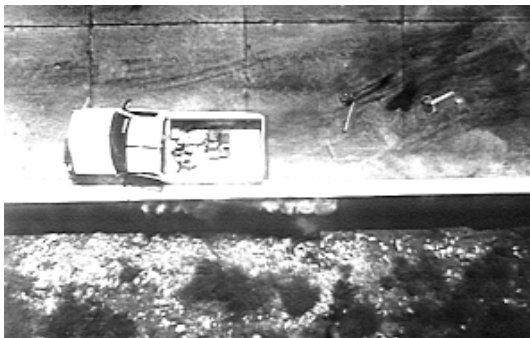
0.142 s



0.190 s



0.237 s



0.297 s



**Figure 40. Sequential Photographs for Test 442882-2
(Overhead and Frontal Views) (continued).**



0.000 s



0.142 s



0.024 s



0.190 s



0.047 s



0.237 s



0.095 s



0.297 s

**Figure 41. Sequential Photographs for Test 442882-2
(Rear View).**



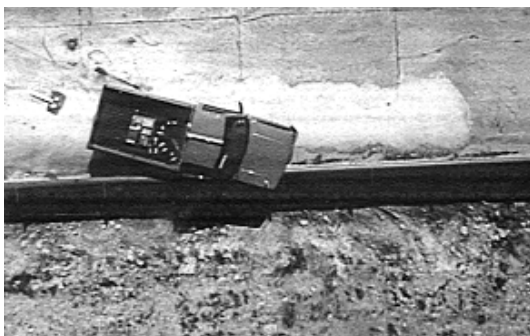
0.000 s



0.039 s



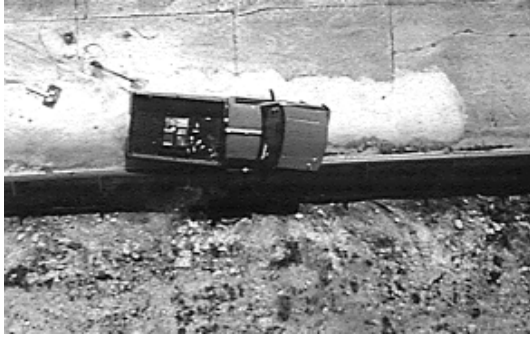
0.077 s



0.129 s



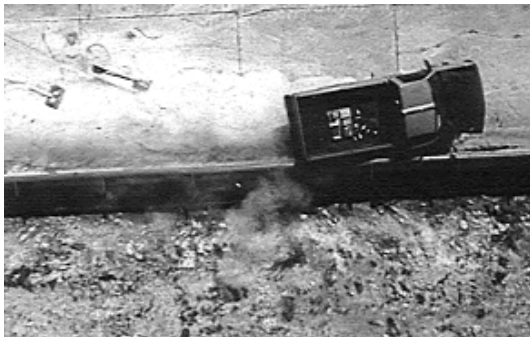
Figure 42. Sequential Photographs for Test 442882-3 (Overhead and Frontal Views).



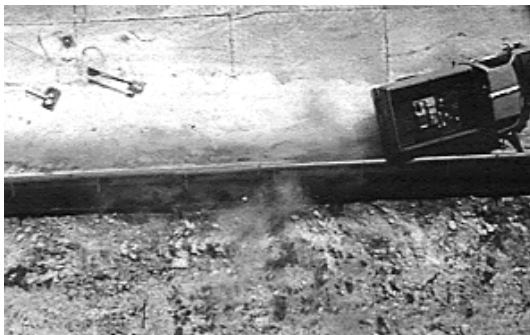
0.180 s



0.257 s



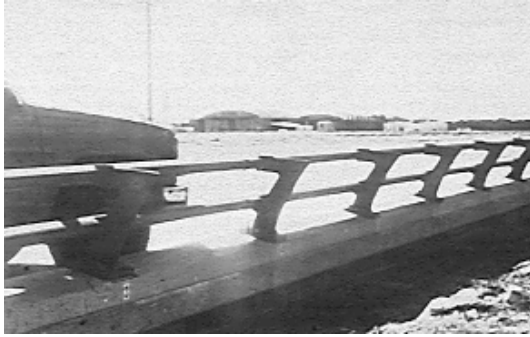
0.386 s



0.514 s



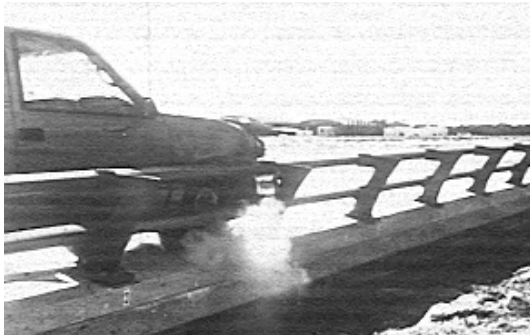
**Figure 42. Sequential Photographs for Test 442882-3
(Overhead and Frontal Views) (continued).**



0.000 s



0.180 s



0.039 s



0.257 s



0.077 s



0.386 s



0.129 s



0.514 s

Figure 43. Sequential Photographs for Test 442882-3 (Rear View).



0.000 s



0.025 s



0.049 s



0.098 s



Figure 44. Sequential Photographs for Test 442882-4 (Overhead and Frontal Views).



0.147 s



0.221 s



0.294 s



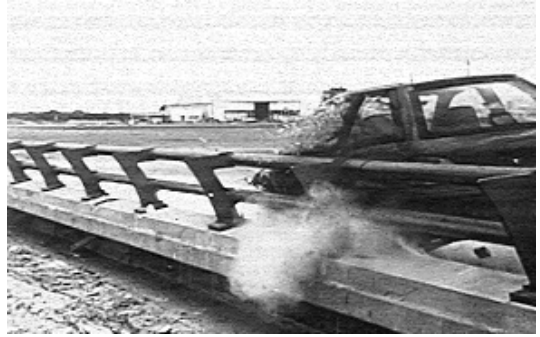
0.368 s



**Figure 44. Sequential Photographs for Test 442882-4
(Overhead and Frontal Views) (continued).**



0.000 s



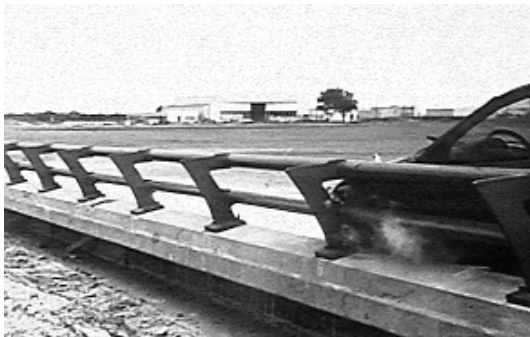
0.147 s



0.025 s



0.221 s



0.049 s



0.294 s



0.098 s



0.368 s

**Figure 45. Sequential Photographs for Test 442882-4
(Rear View).**

Roll, Pitch and Yaw Angles

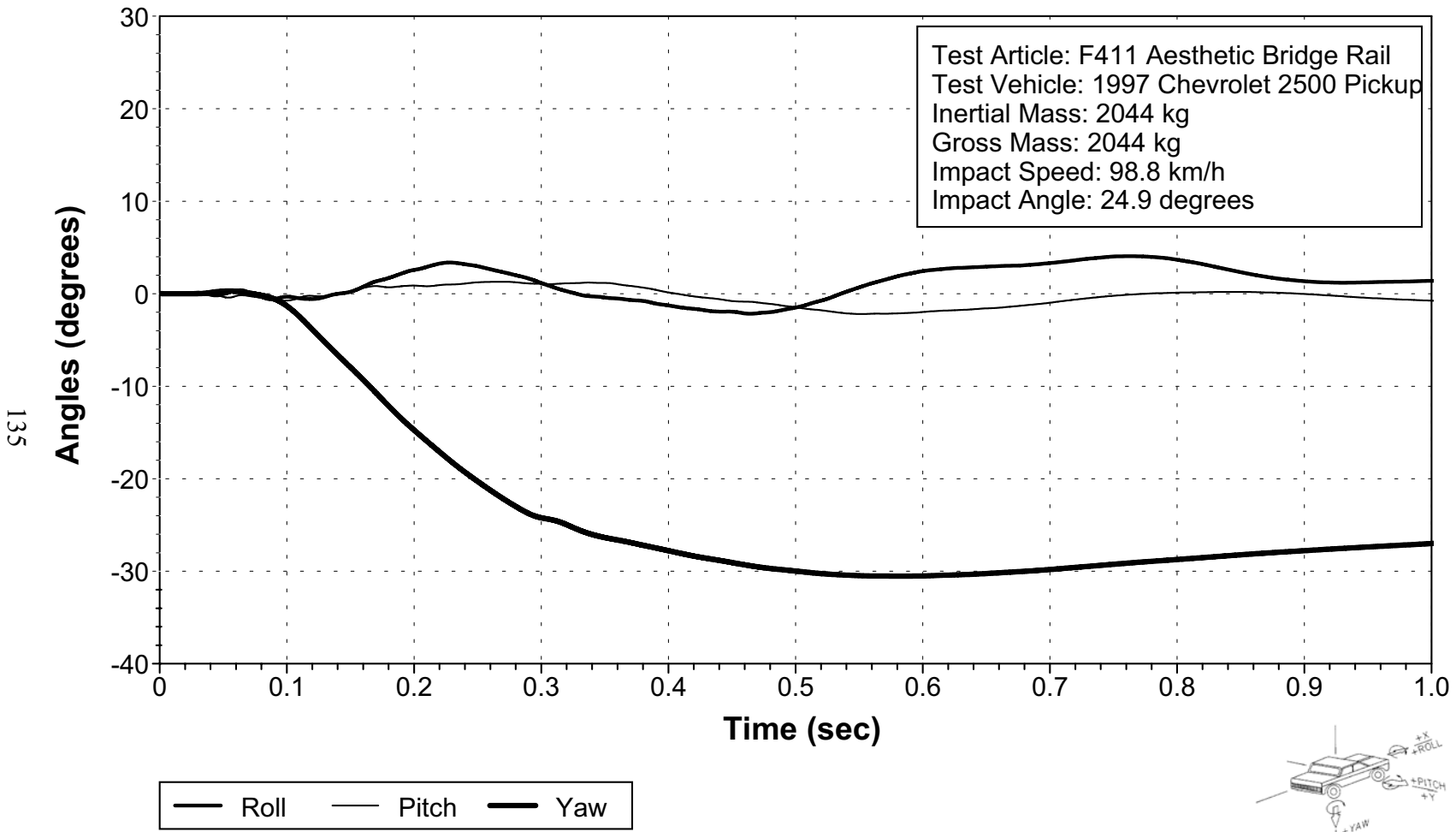


Figure 46. Vehicular Angular Displacements for Test 442882-1.

Roll, Pitch and Yaw Angles

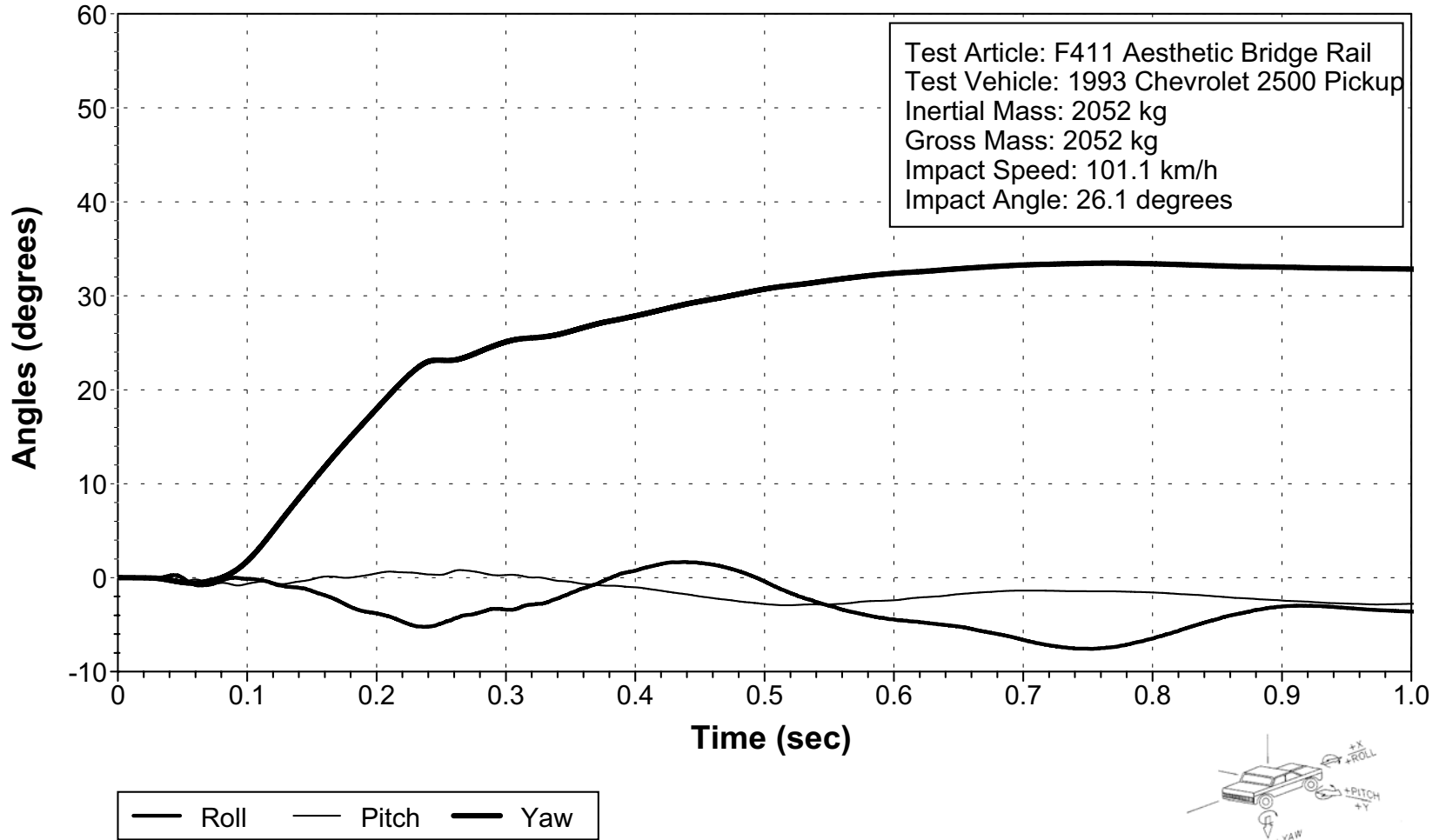


Figure 47. Vehicular Angular Displacements for Test 442882-2.

Roll, Pitch and Yaw Angles

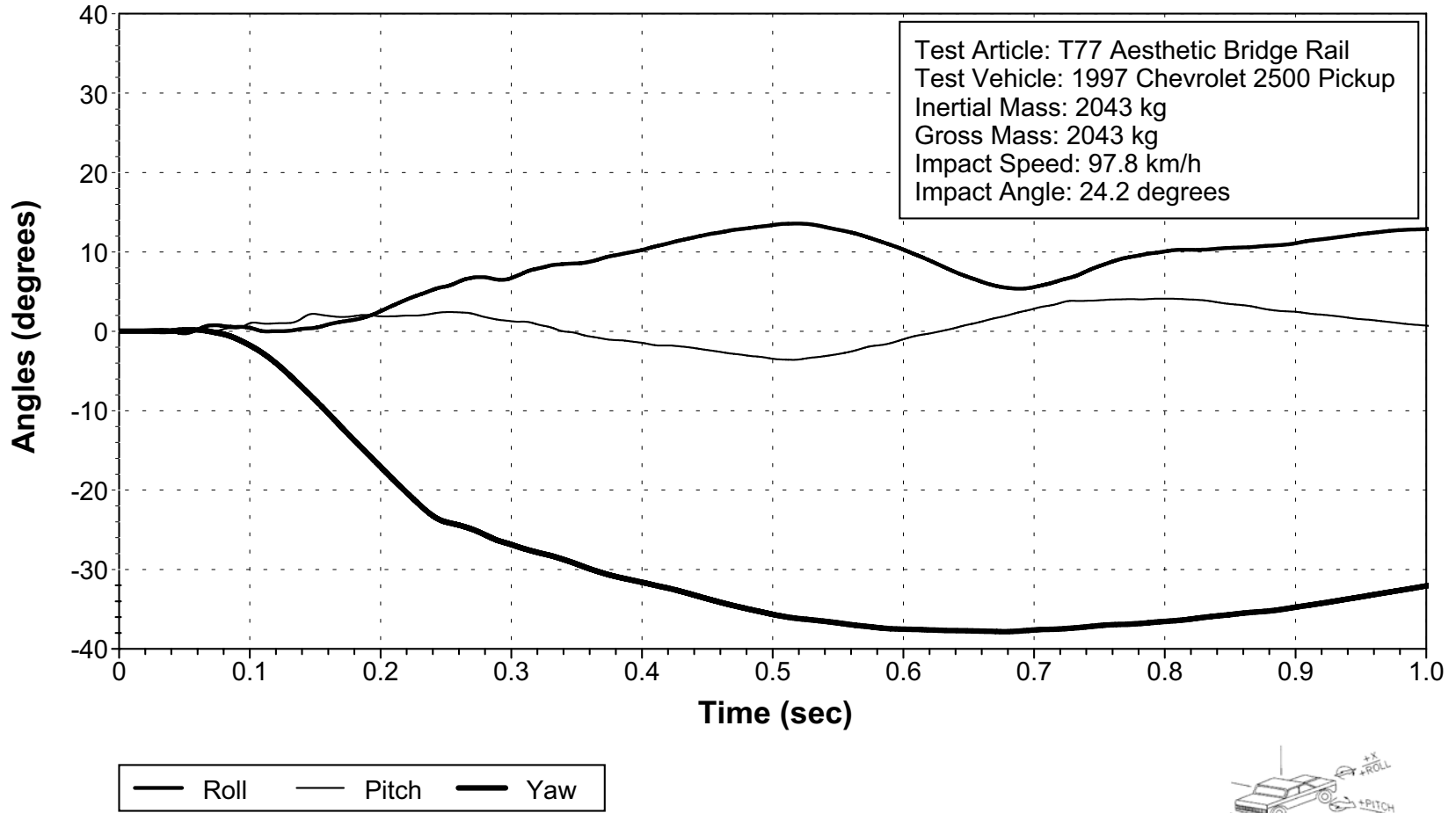


Figure 48. Vehicular Angular Displacements for Test 442882-3.

Roll, Pitch and Yaw Angles

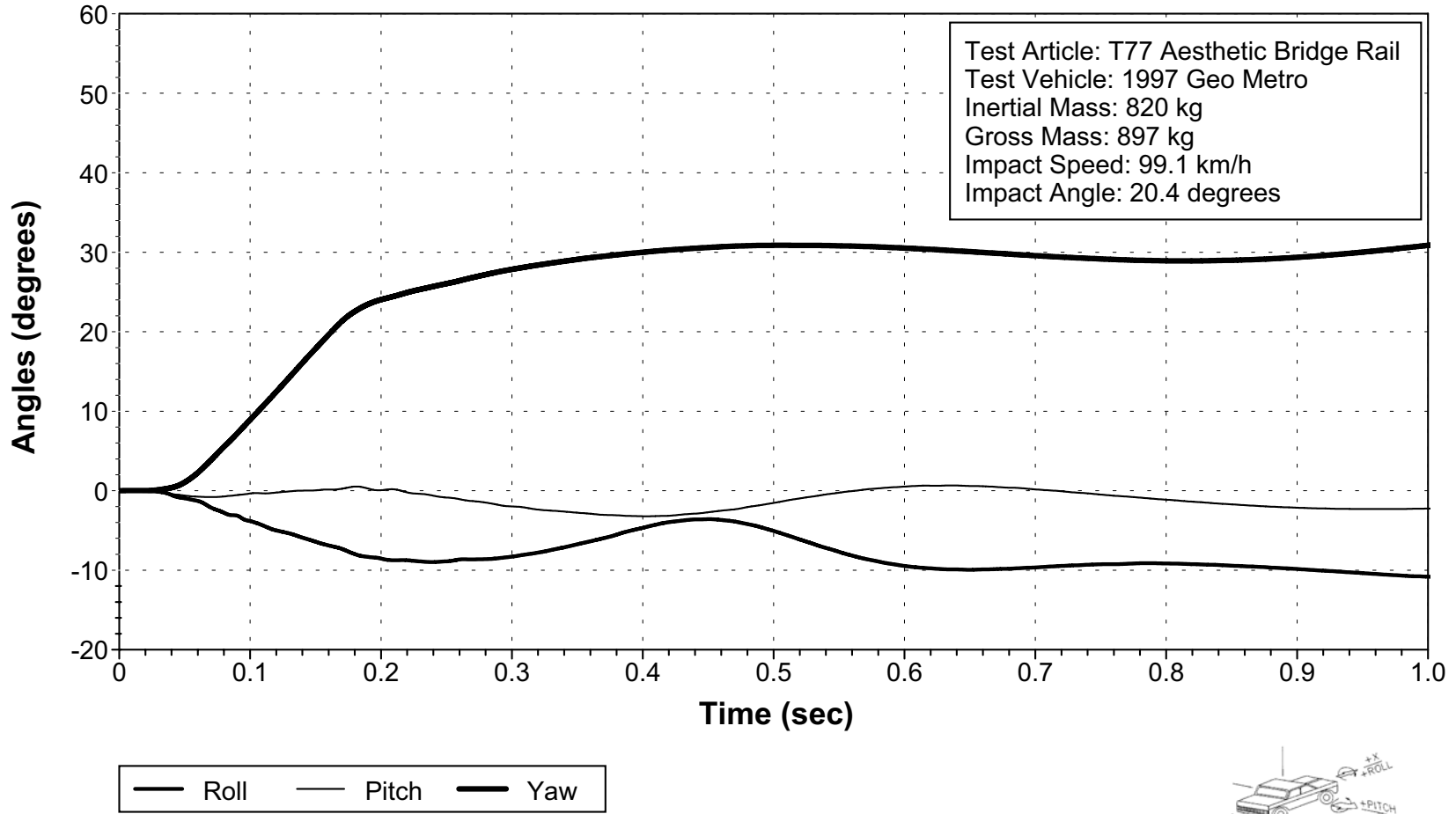


Figure 49. Vehicular Angular Displacements for Test 442882-4.

X Acceleration at CG

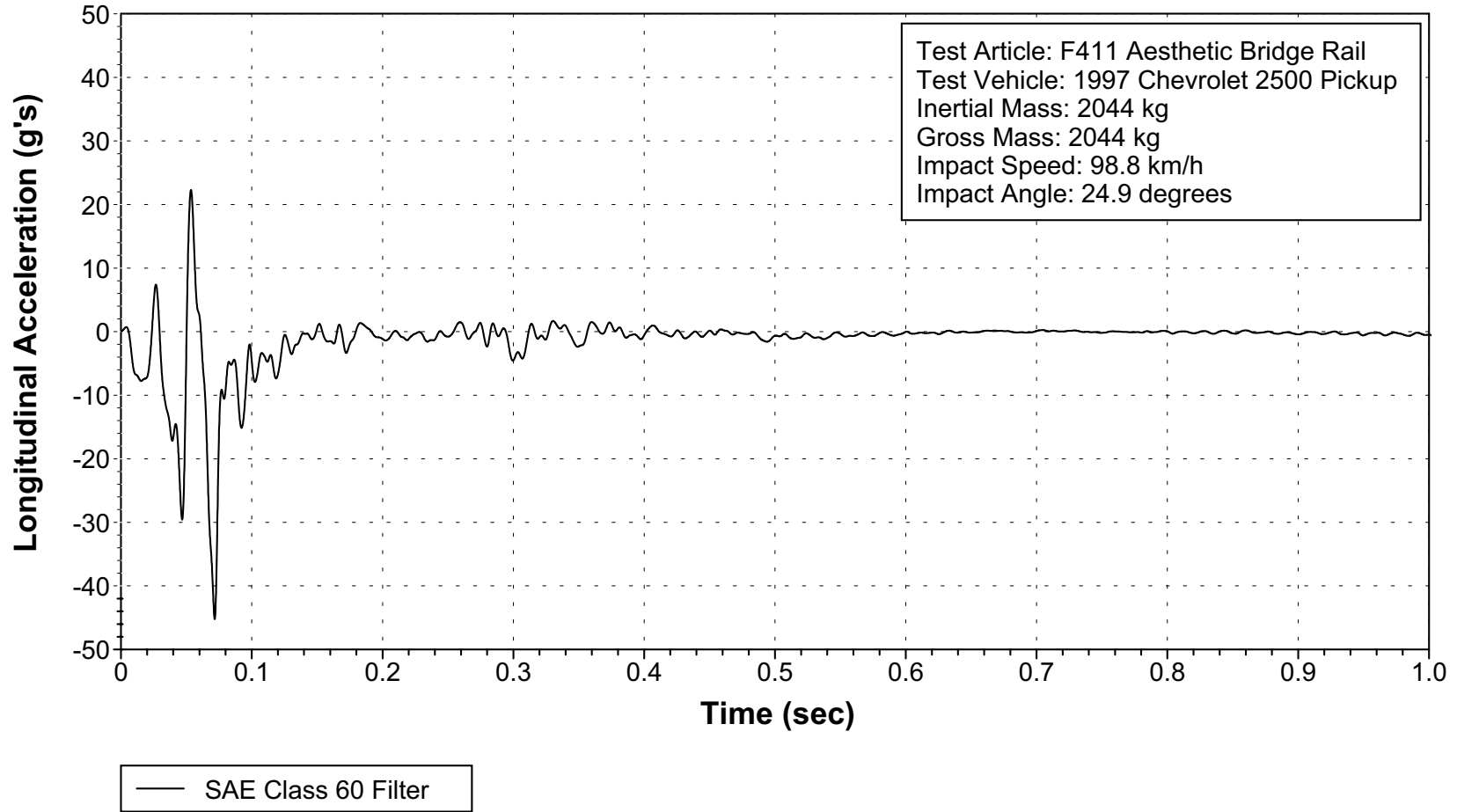
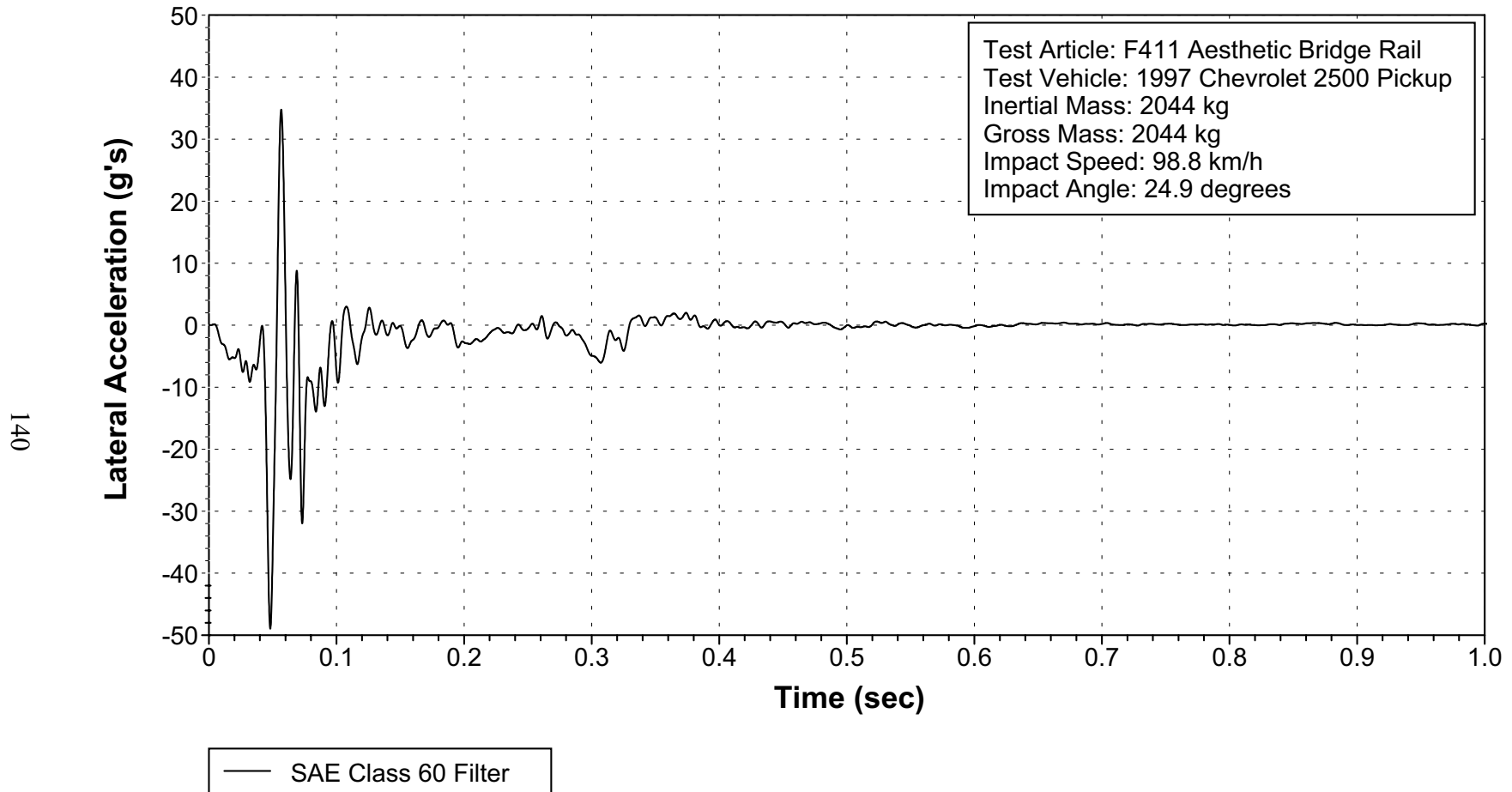


Figure 50. Vehicle Longitudinal Accelerometer Trace for Test 442882-1 (Accelerometer Located at Center of Gravity).

Y Acceleration at CG



**Figure 51. Vehicle Lateral Accelerometer Trace for Test 442882-1
(Accelerometer Located at Center of Gravity).**

Z Acceleration at CG

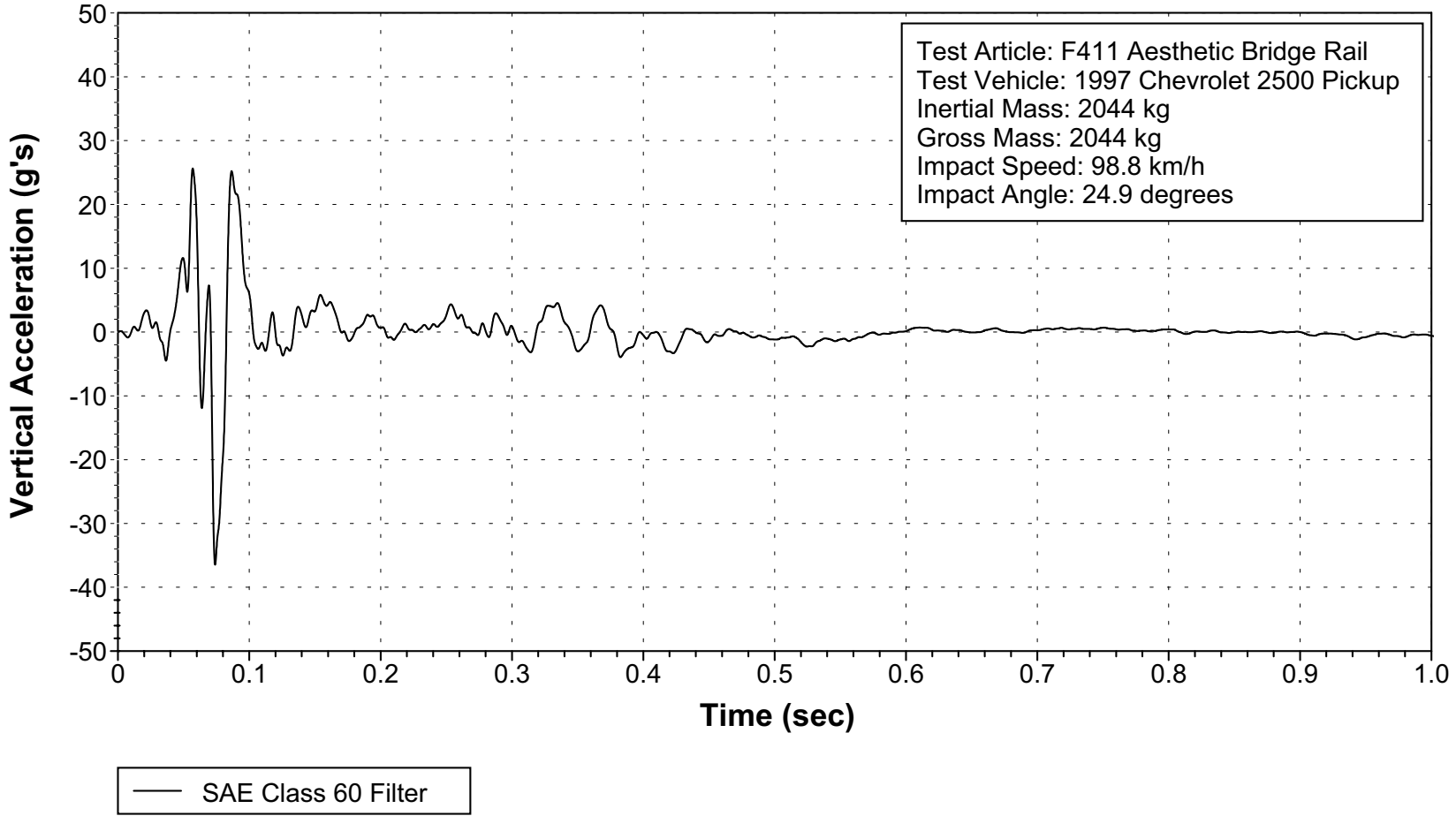
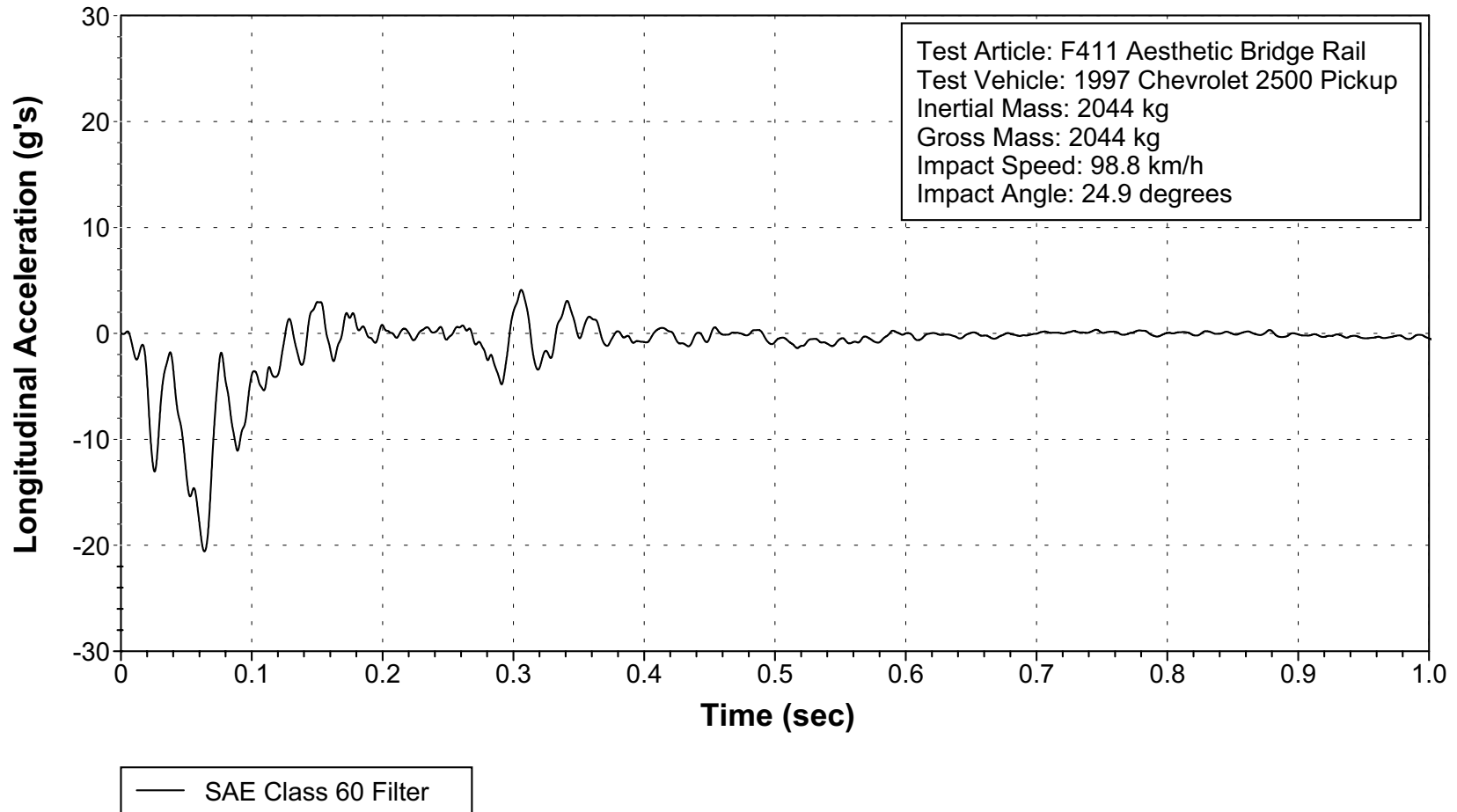


Figure 52. Vehicle Vertical Accelerometer Trace for Test 442882-1 (Accelerometer Located at Center of Gravity).

X Acceleration Over Rear Axle



142

**Figure 53. Vehicle Longitudinal Accelerometer Trace for Test 442882-1
(Accelerometer Located Over Rear Axle).**

Y Acceleration Over Rear Axle

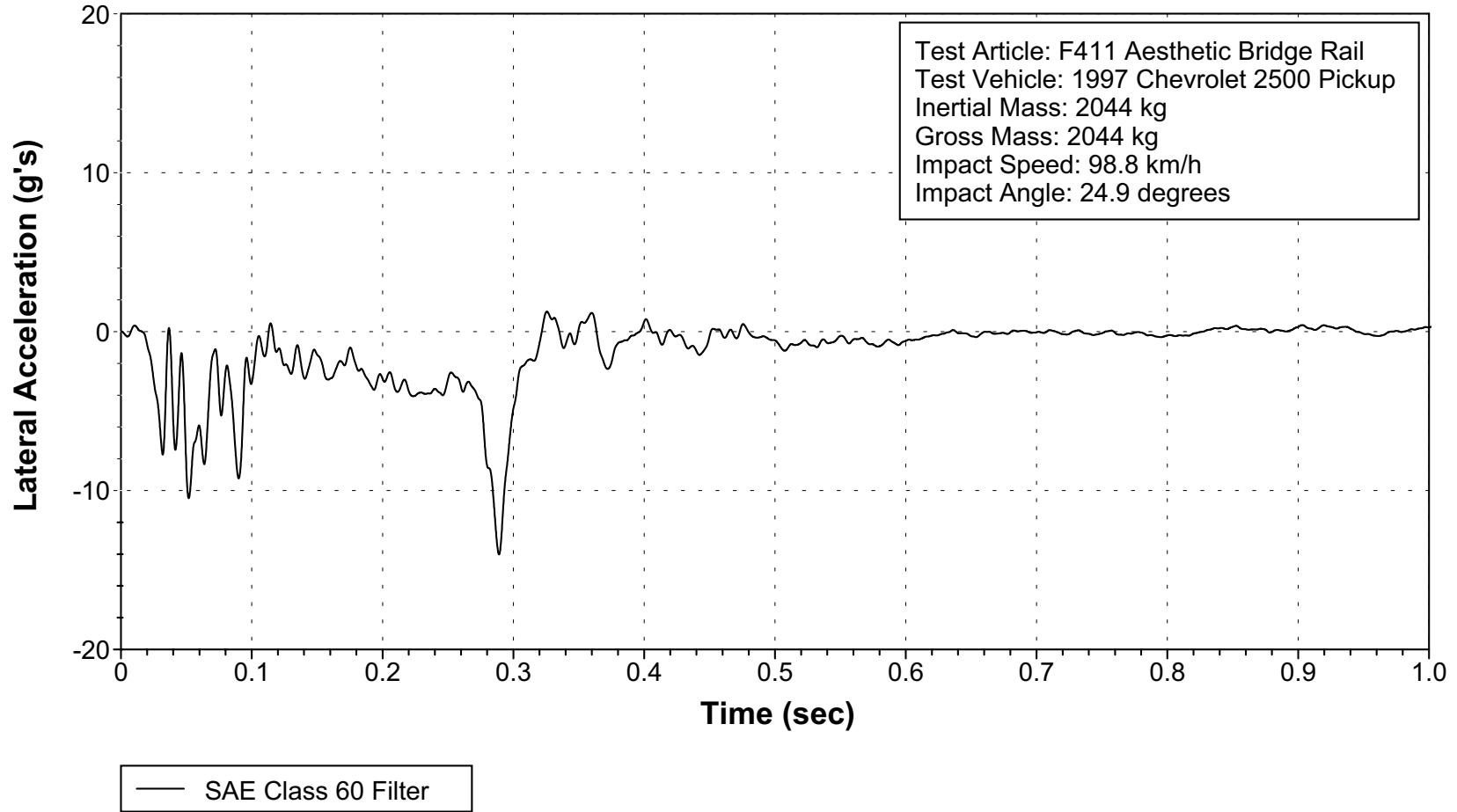
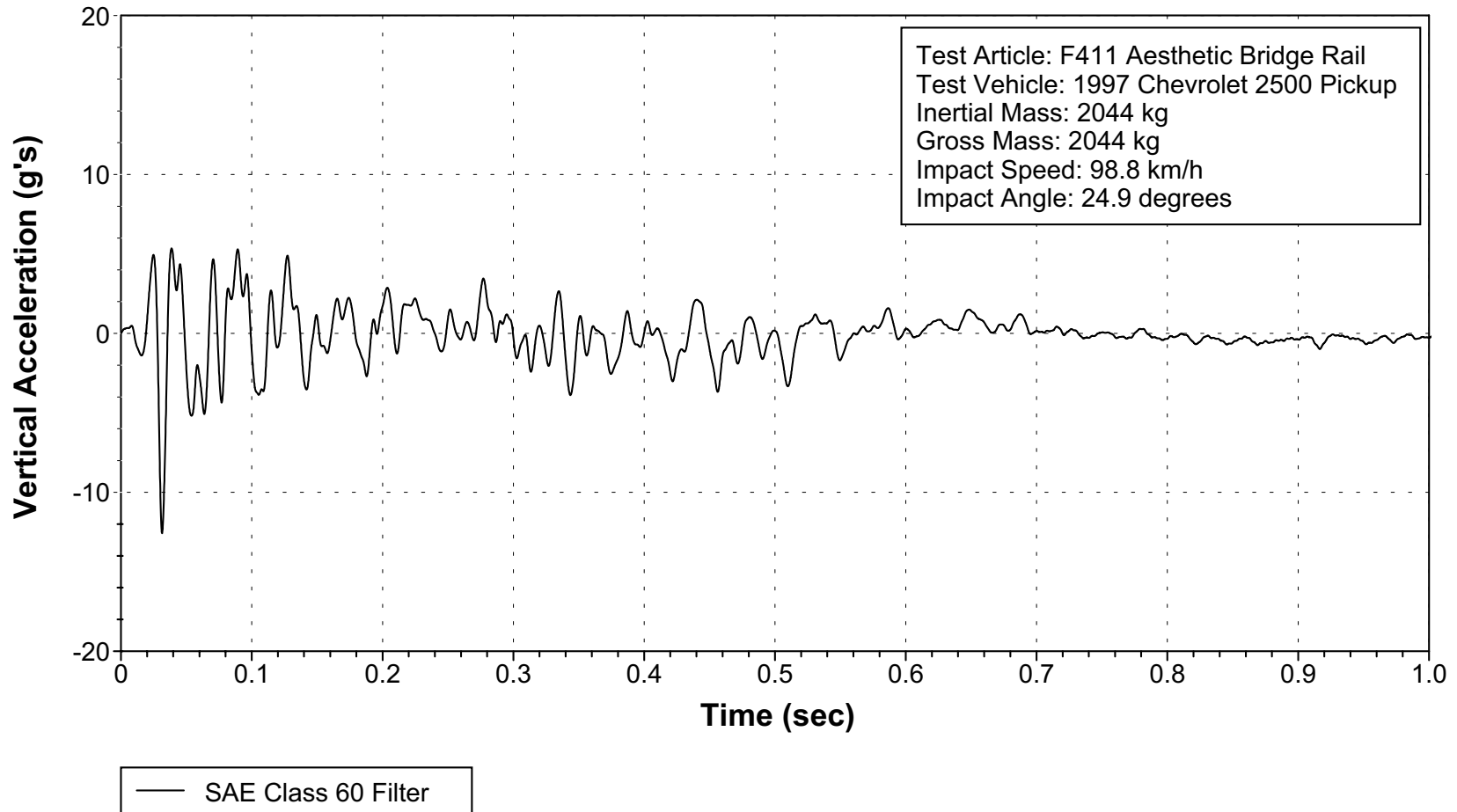


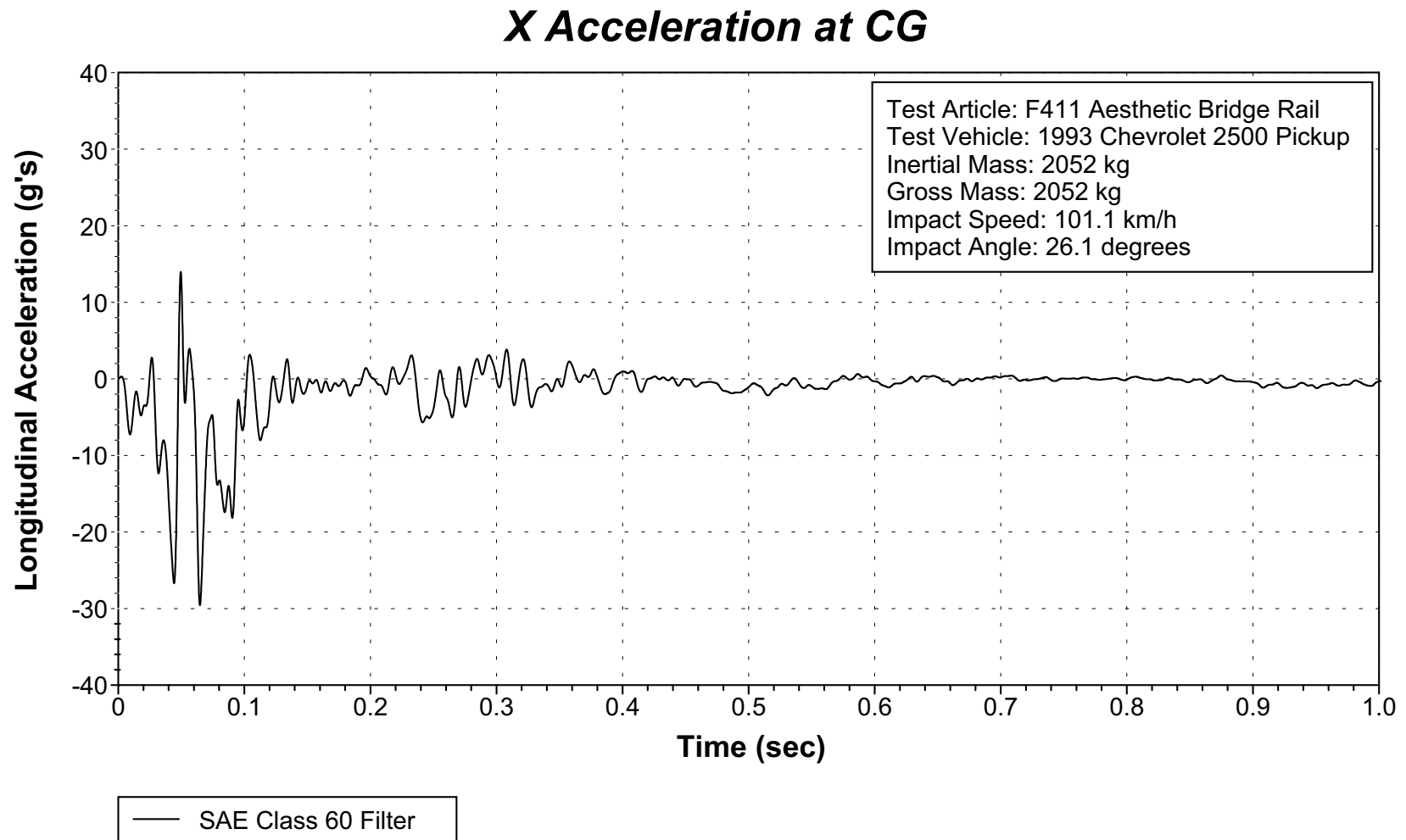
Figure 54. Vehicle Lateral Accelerometer Trace for Test 442882-1 (Accelerometer Located Over Rear Axle).

Z Acceleration Over Rear Axle

144



**Figure 55. Vehicle Vertical Accelerometer Trace for Test 442882-1
(Accelerometer Located Over Rear Axle).**



**Figure 56. Vehicle Longitudinal Accelerometer Trace for Test 442882-2
(Accelerometer Located at Center of Gravity).**

Y Acceleration at CG

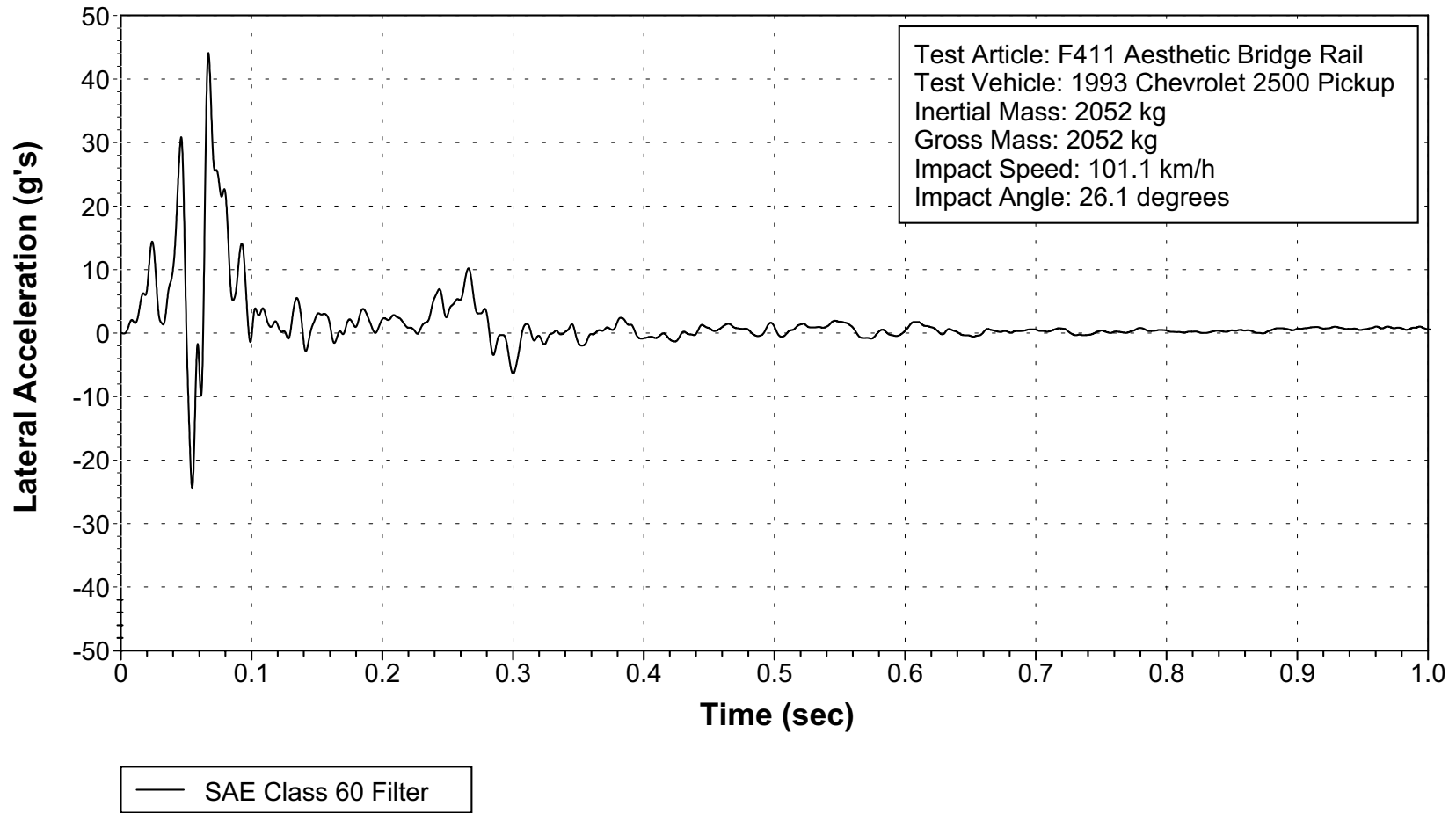


Figure 57. Vehicle Lateral Accelerometer Trace for Test 442882-2 (Accelerometer Located at Center of Gravity).

Z Acceleration at CG

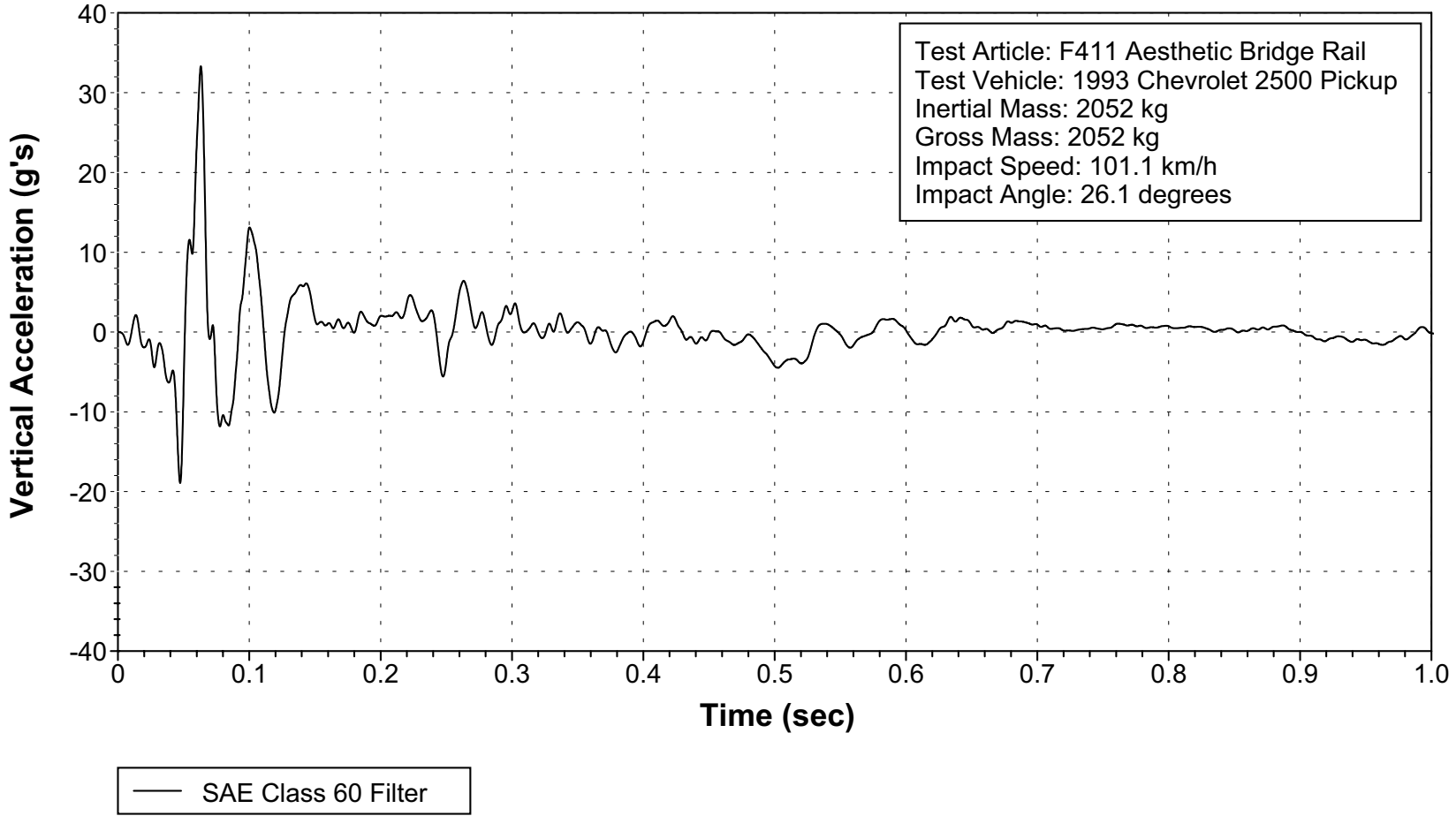
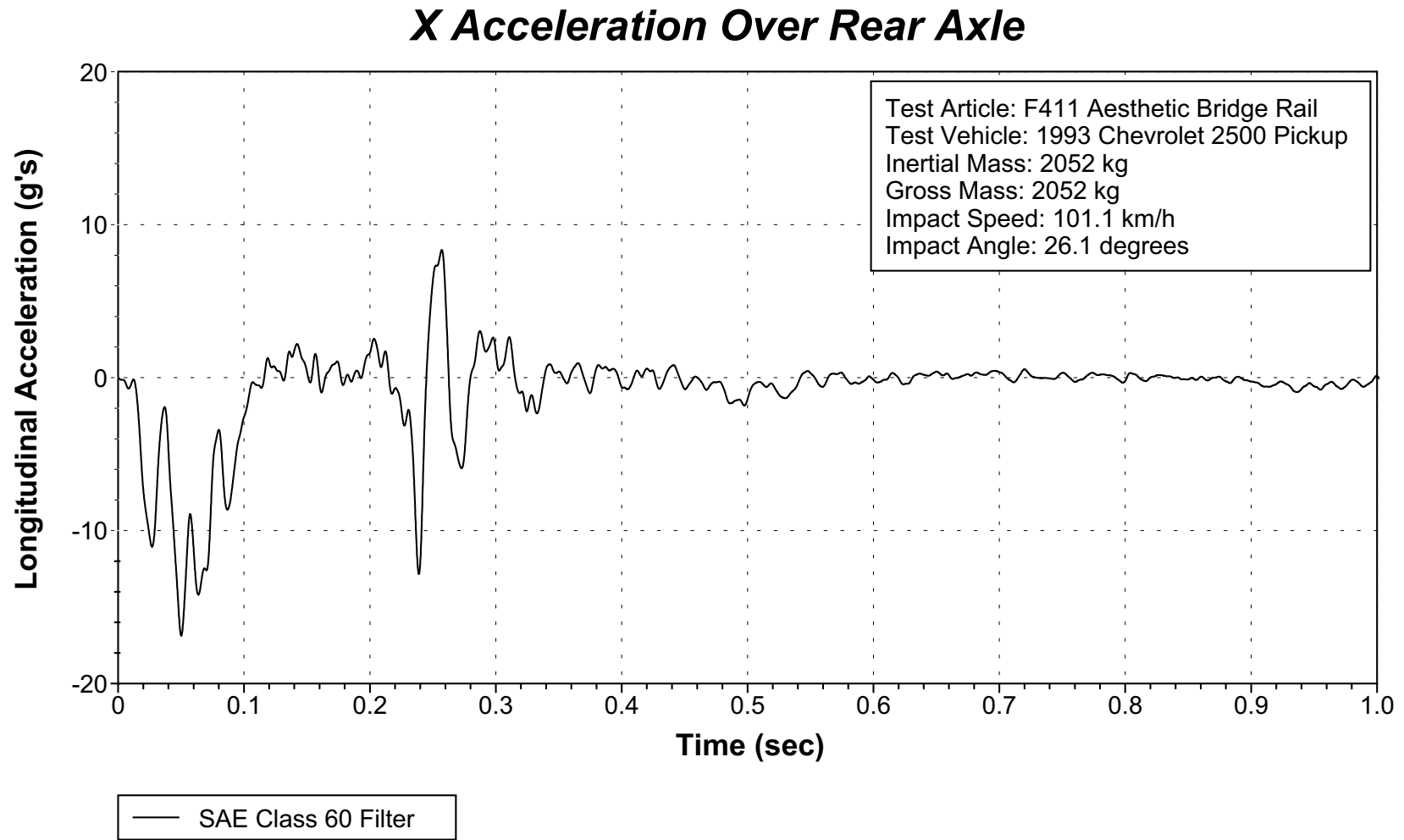


Figure 58. Vehicle Vertical Accelerometer Trace for Test 442882-2 (Accelerometer Located at Center of Gravity).



**Figure 59. Vehicle Longitudinal Accelerometer Trace for Test 442882-2
(Accelerometer Located Over Rear Axle).**

Y Acceleration Over Rear Axle

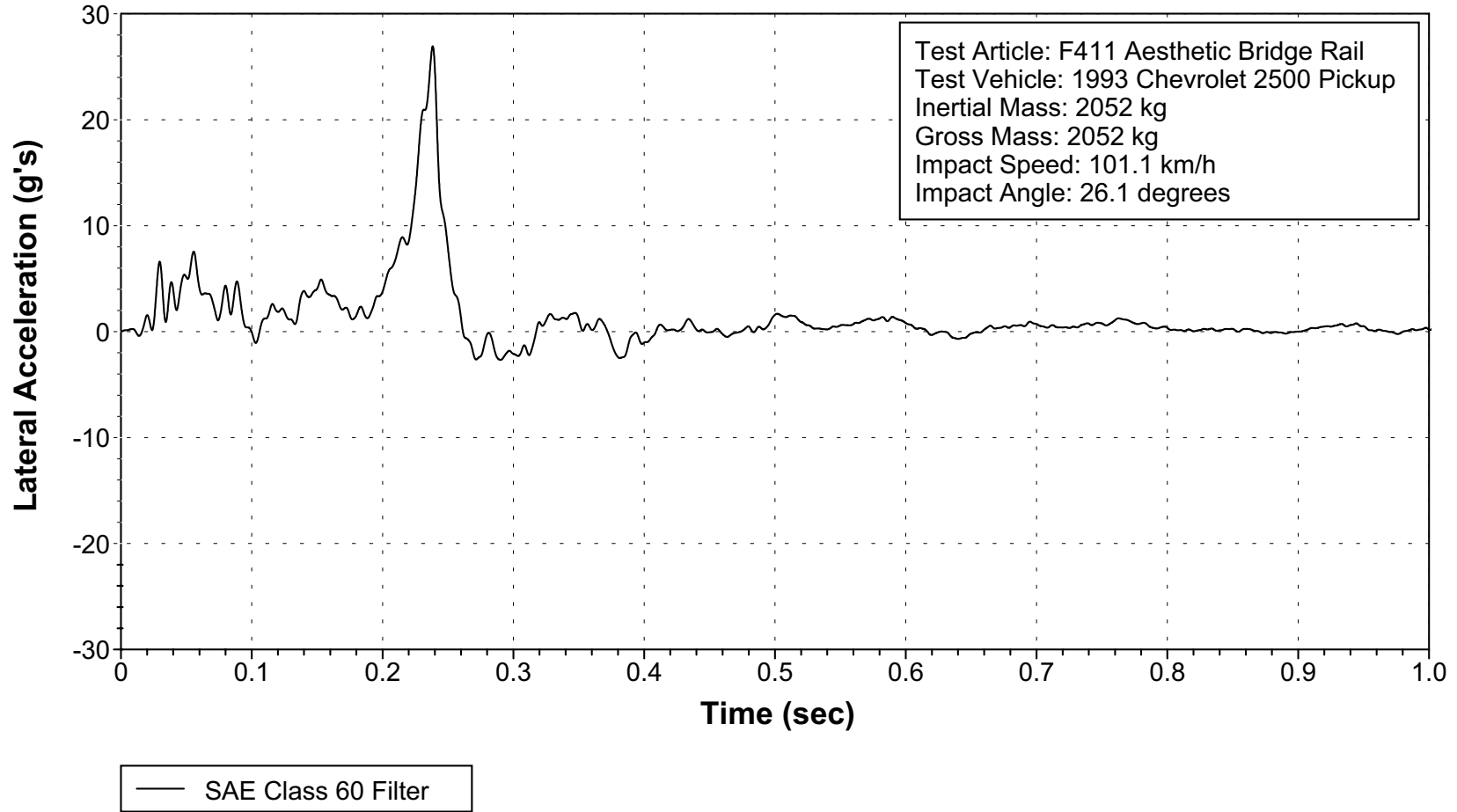
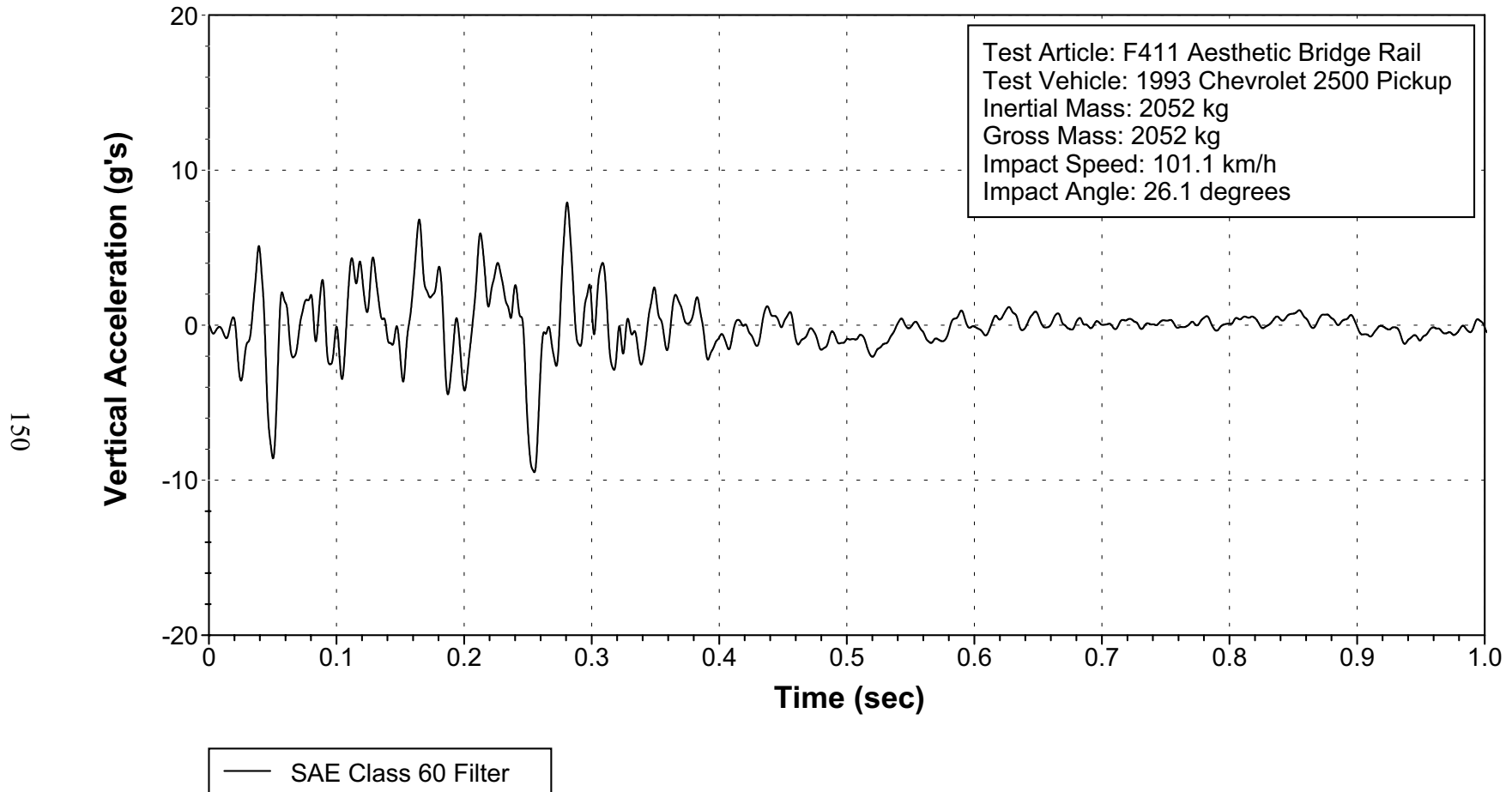
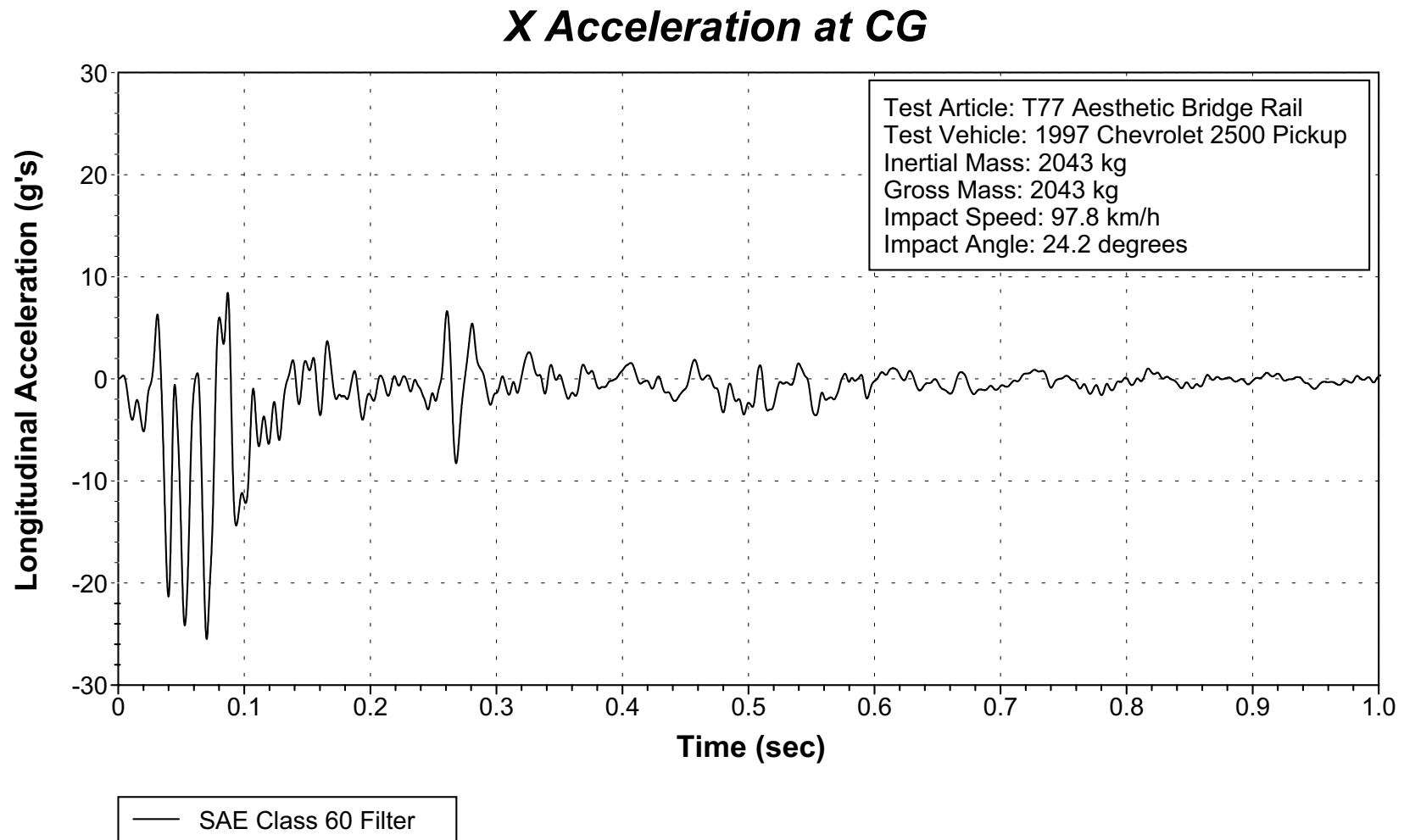


Figure 60. Vehicle Lateral Accelerometer Trace for Test 442882-2 (Accelerometer Located Over Rear Axle).

Z Acceleration Over Rear Axle



**Figure 61. Vehicle Vertical Accelerometer Trace for Test 442882-2
(Accelerometer Located Over Rear Axle).**



**Figure 62. Vehicle Longitudinal Accelerometer Trace for Test 442882-3
(Accelerometer Located at Center of Gravity).**

Y Acceleration at CG

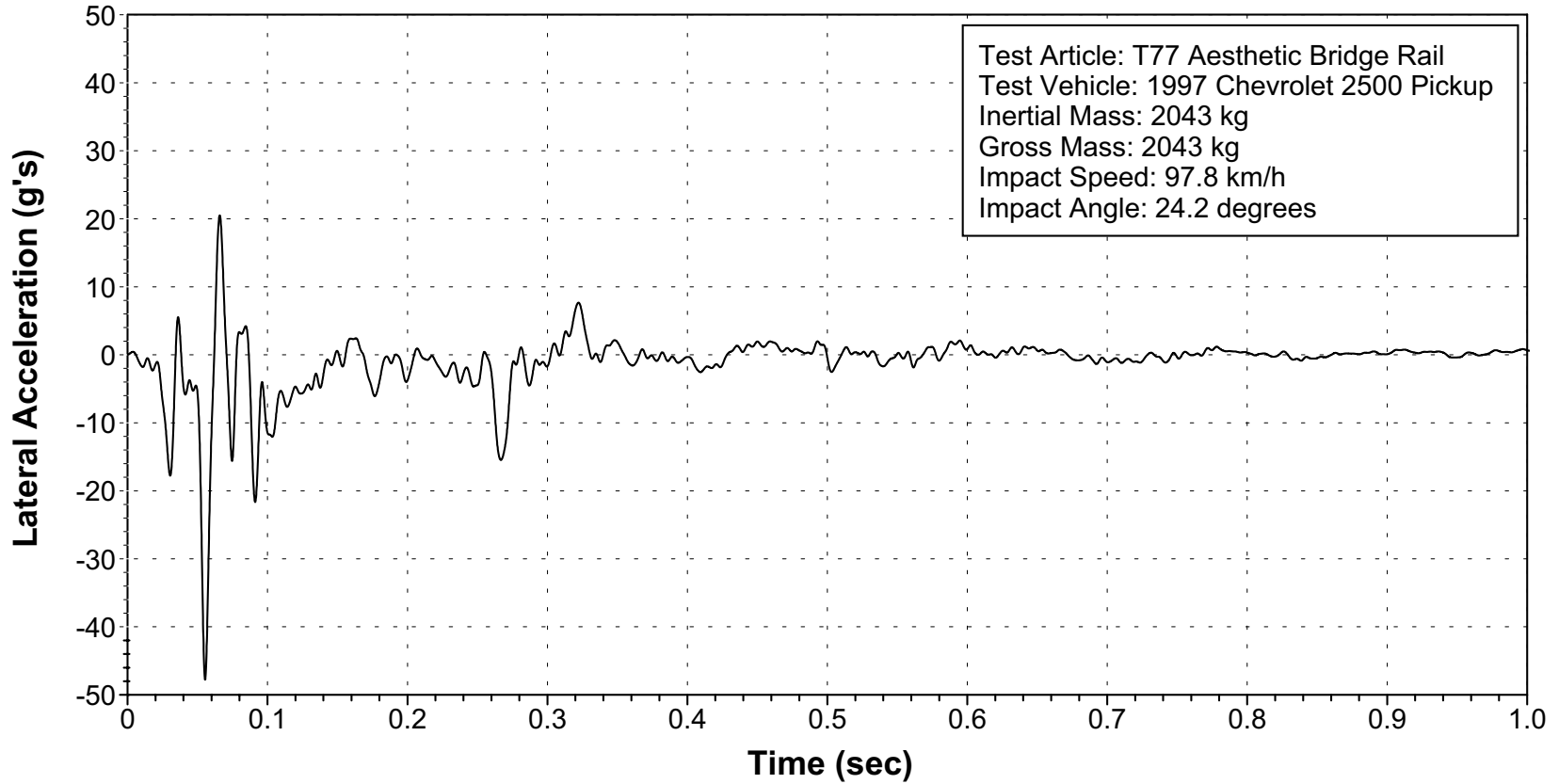
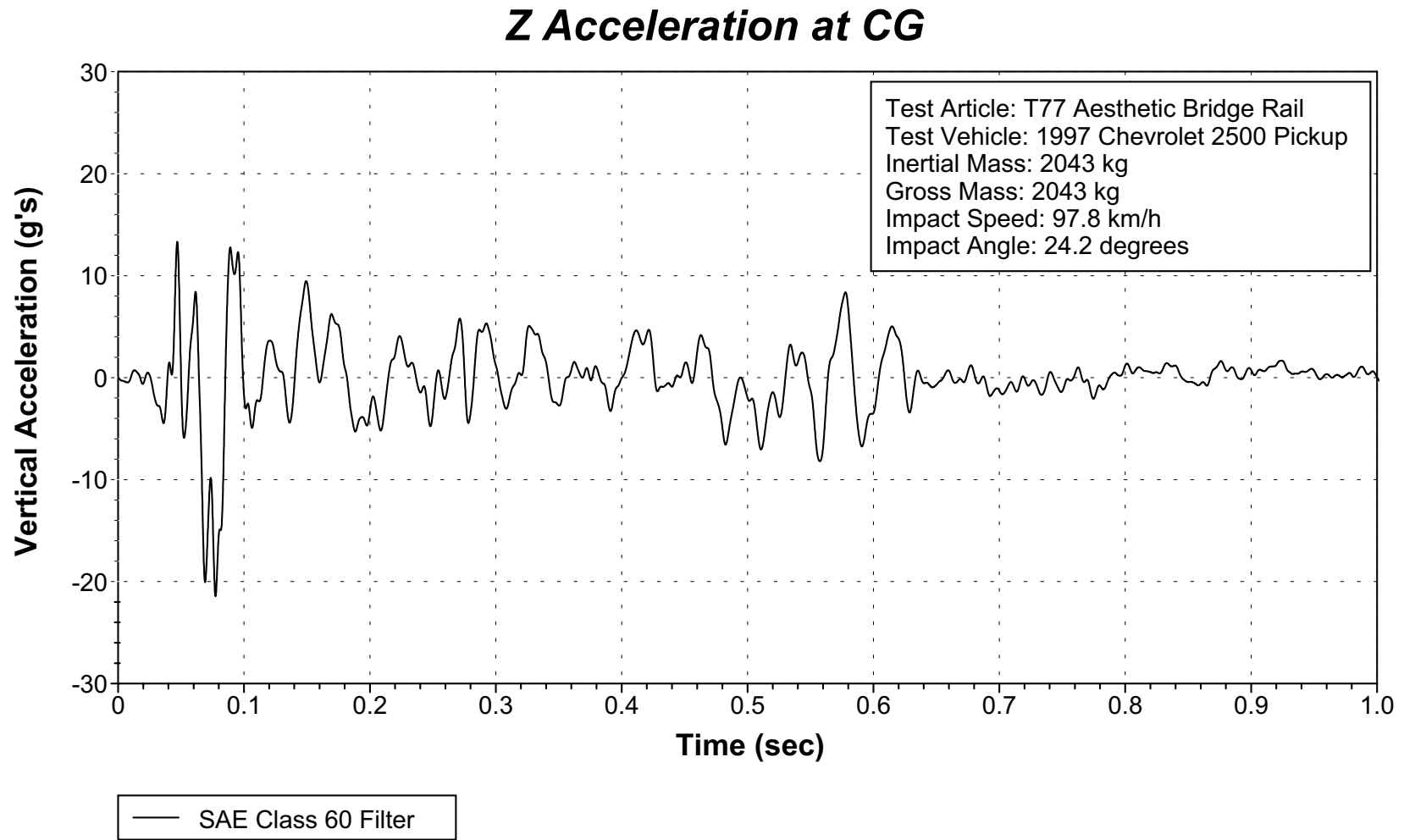
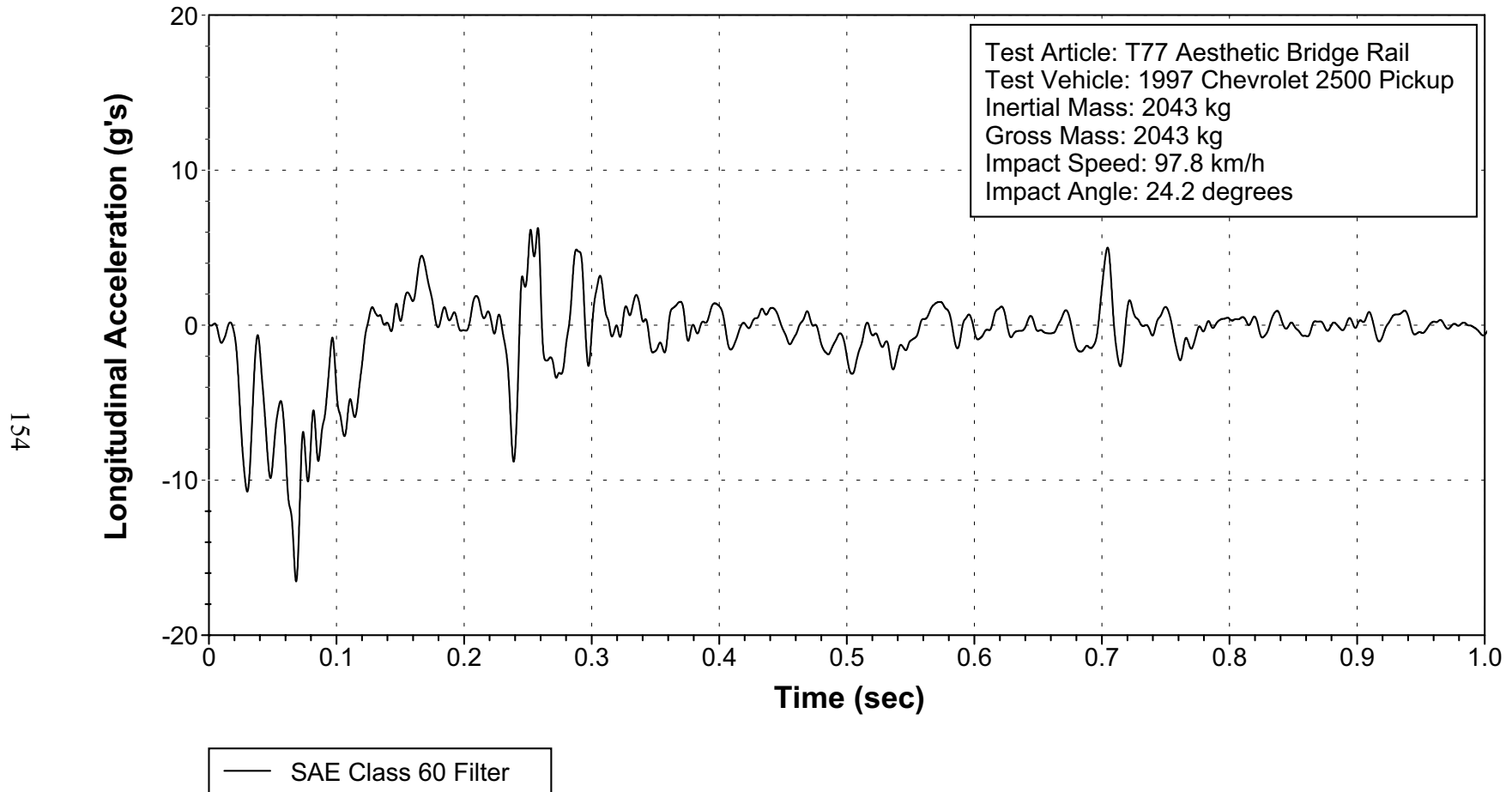


Figure 63. Vehicle Lateral Accelerometer Trace for Test 442882-3 (Accelerometer Located at Center of Gravity).



**Figure 64. Vehicle Vertical Accelerometer Trace for Test 442882-3
(Accelerometer Located at Center of Gravity).**

X Acceleration Over Rear Axle



**Figure 65. Vehicle Longitudinal Accelerometer Trace for Test 442882-3
(Accelerometer Located Over Rear Axle).**

Y Acceleration Over Rear Axle

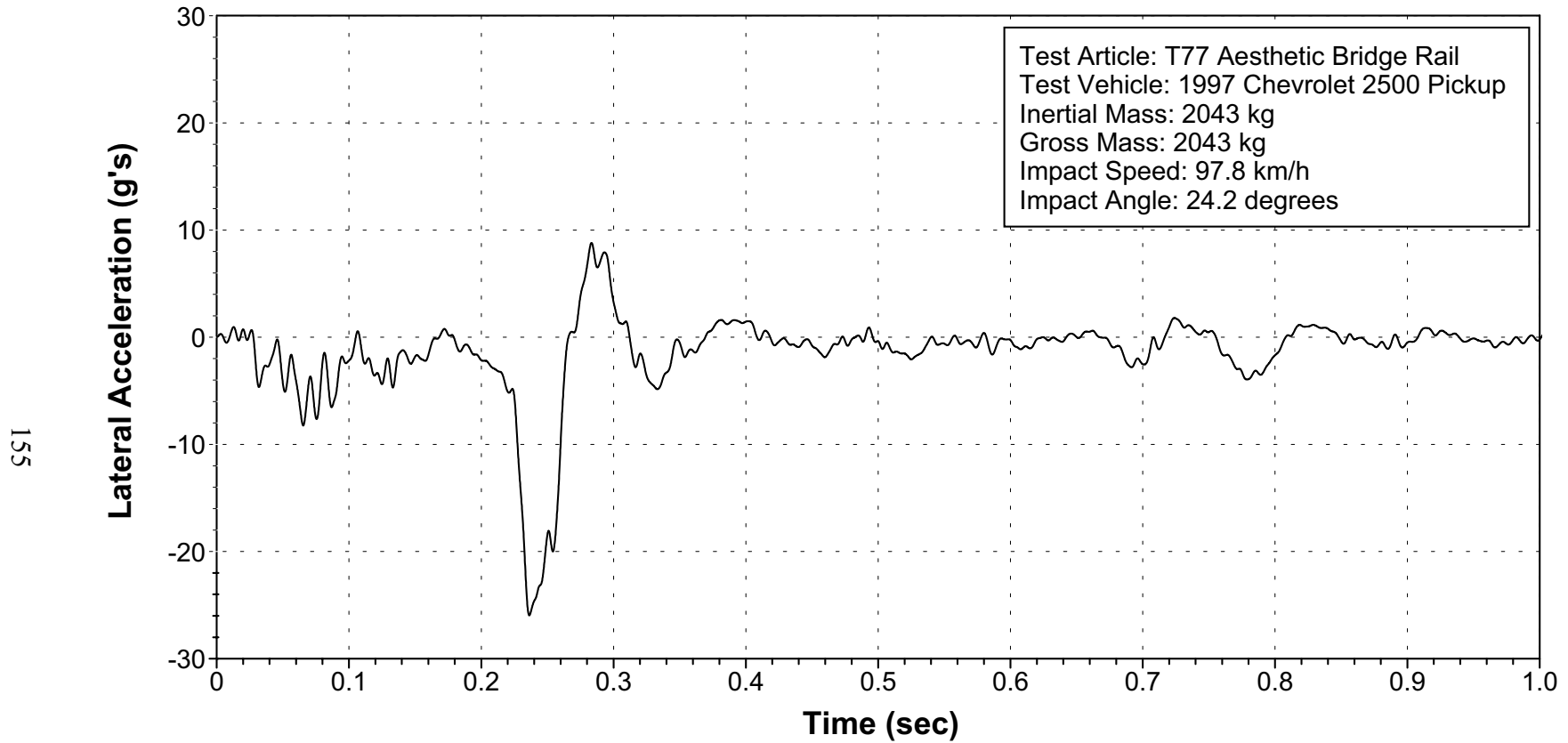


Figure 66. Vehicle Lateral Accelerometer Trace for Test 442882-3
(Accelerometer Located Over Rear Axle).

Z Acceleration Over Rear Axle

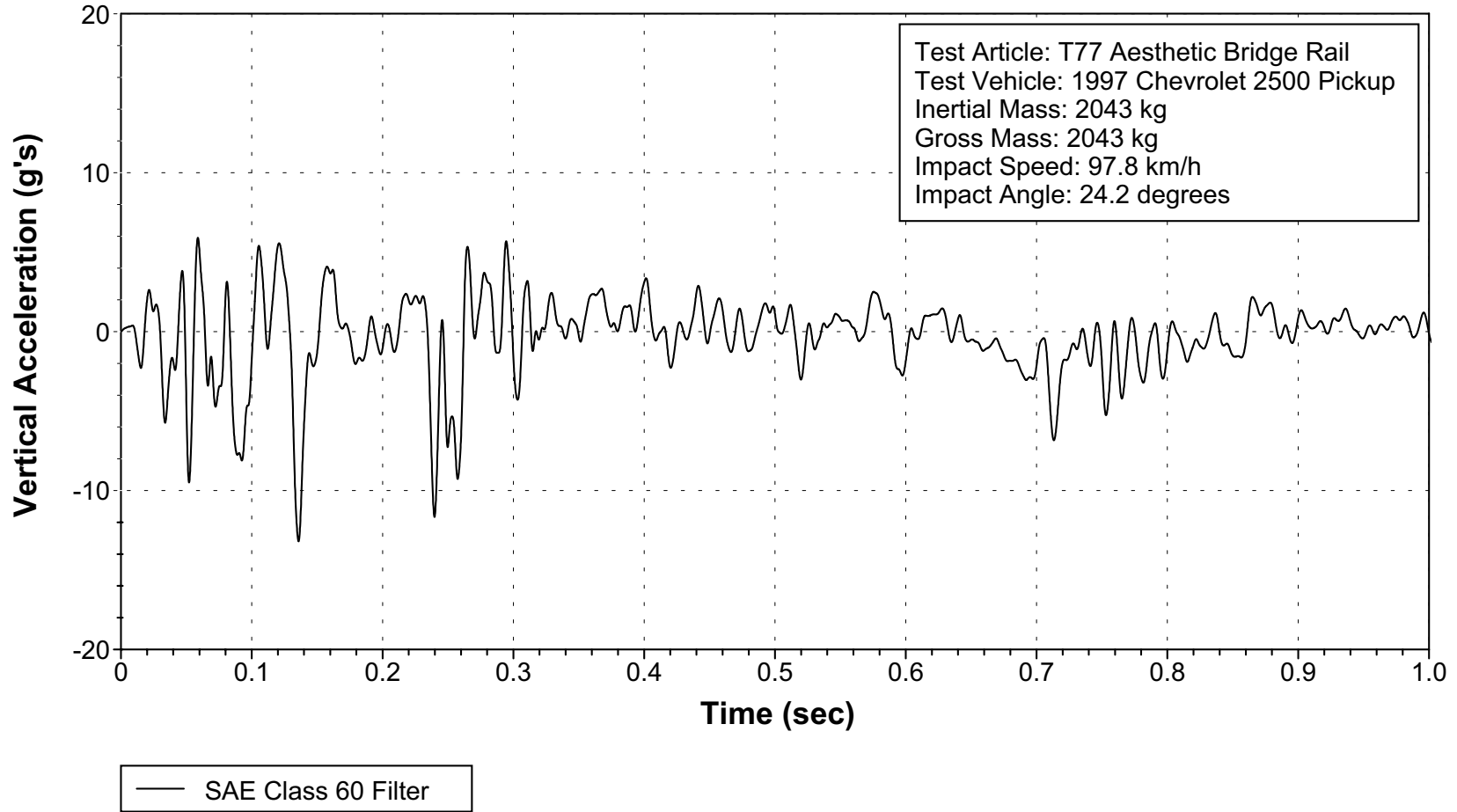
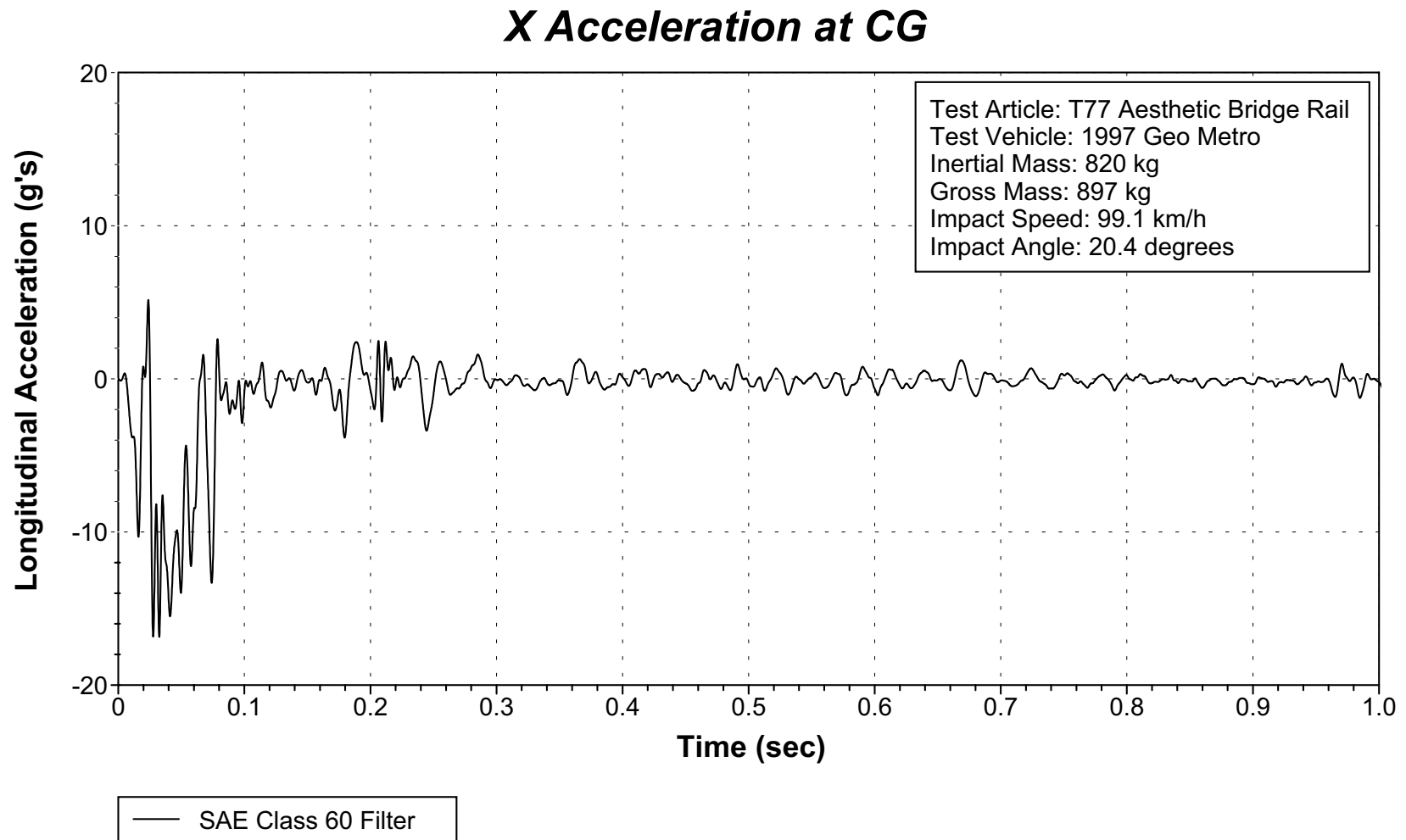
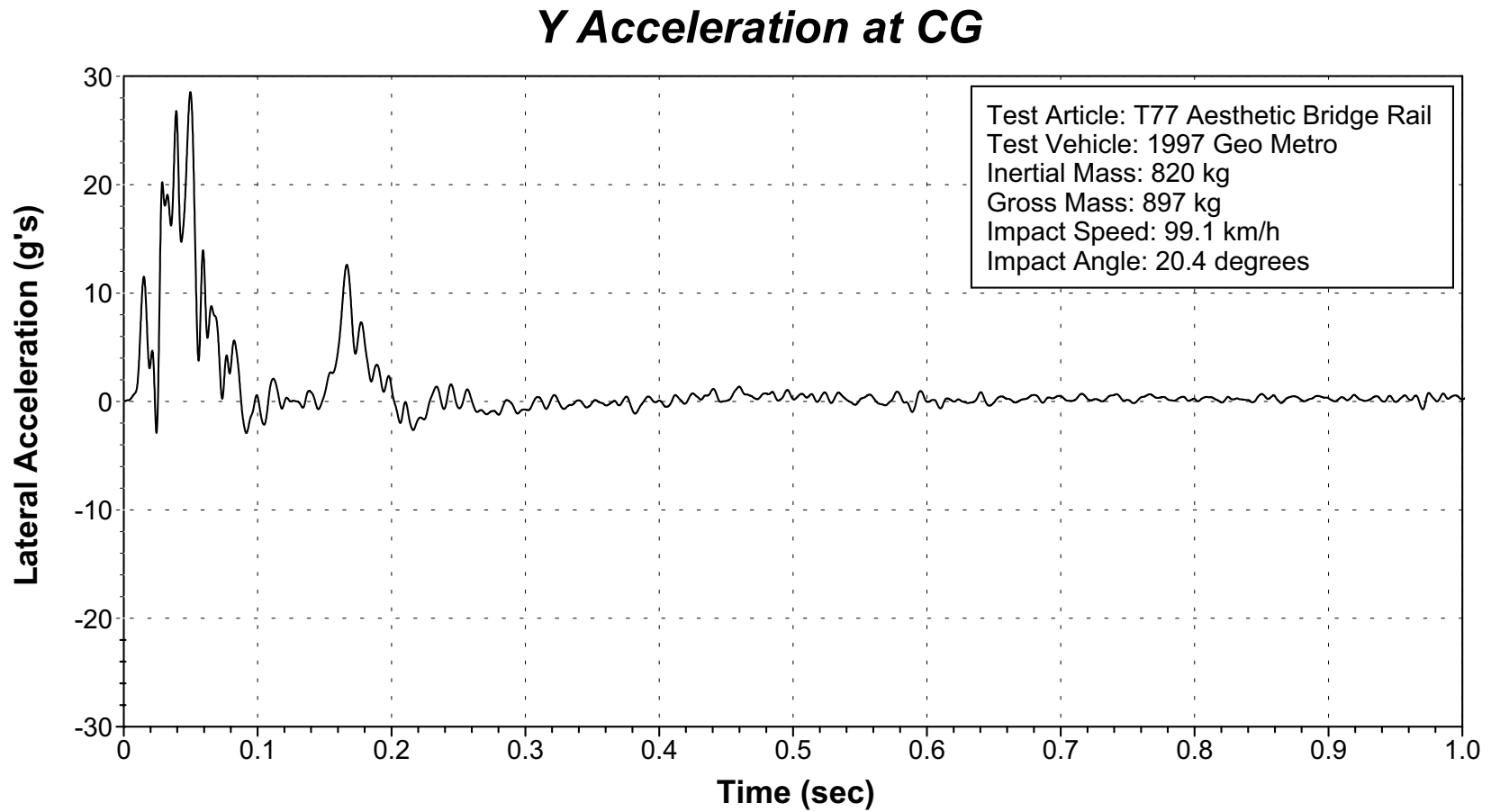


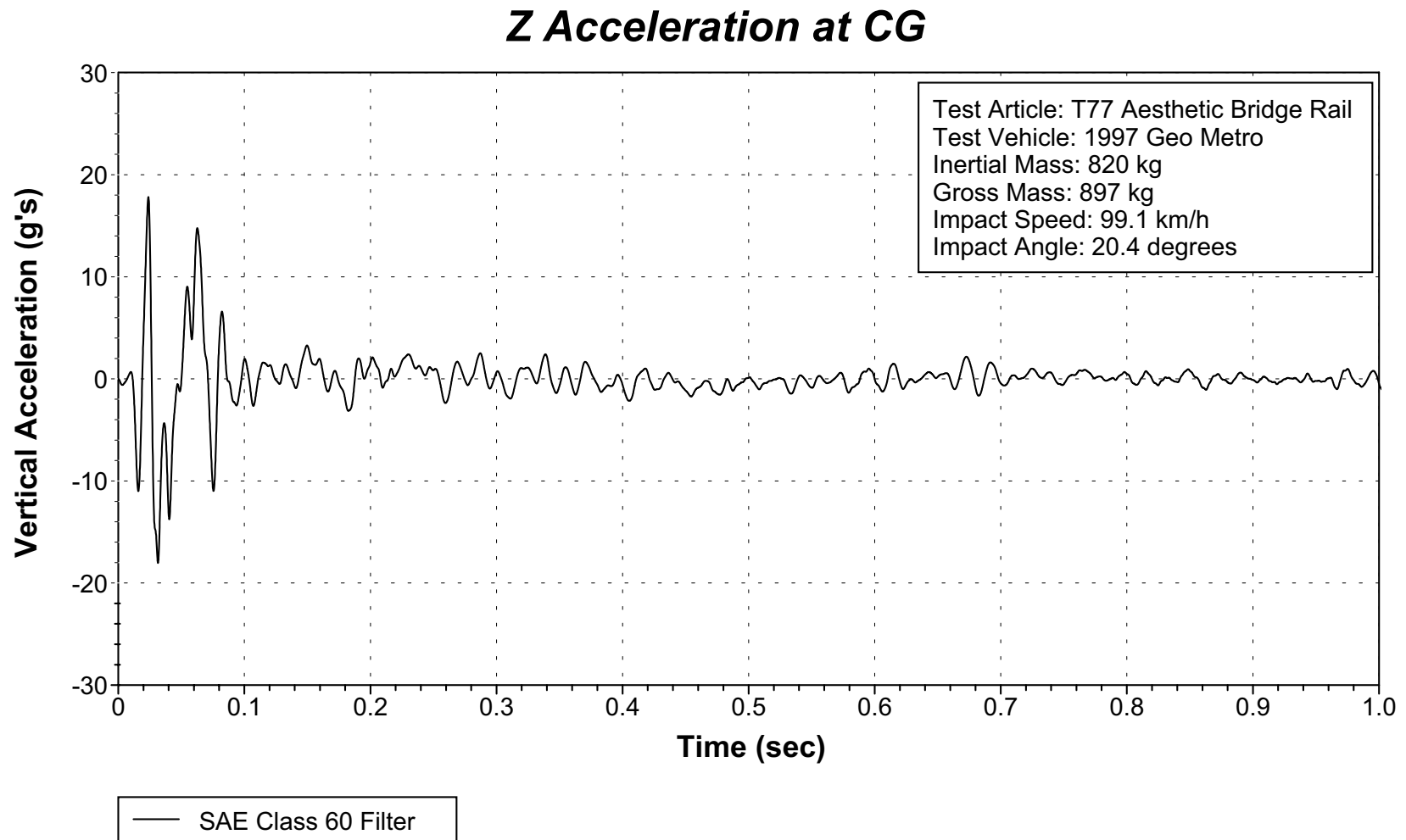
Figure 67. Vehicle Vertical Accelerometer Trace for Test 442882-3 (Accelerometer Located Over Rear Axle).



**Figure 68. Vehicle Longitudinal Accelerometer Trace for Test 442882-4
(Accelerometer Located at Center of Gravity).**

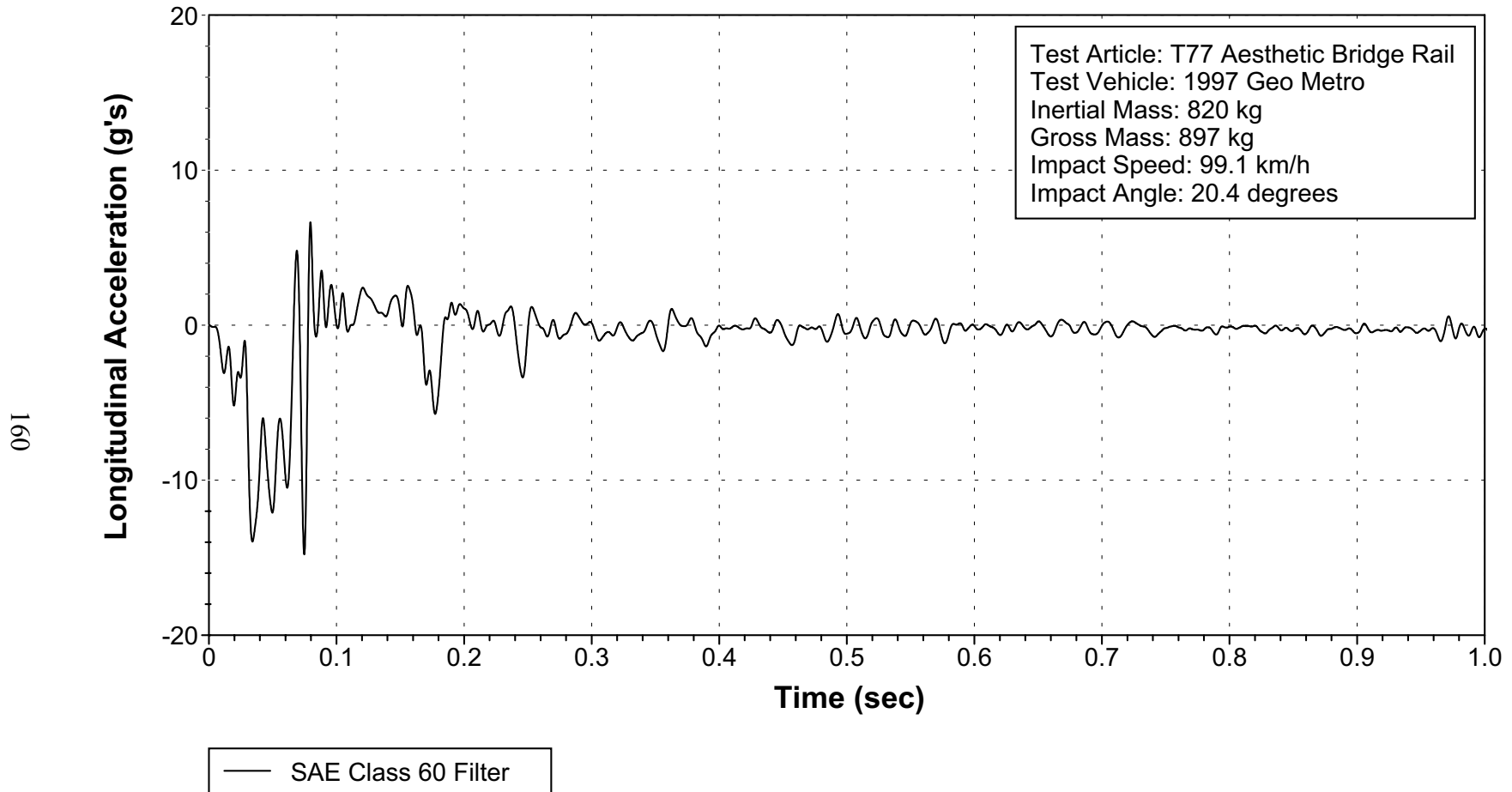


**Figure 69. Vehicle Lateral Accelerometer Trace for Test 442882-4
(Accelerometer Located at Center of Gravity).**



**Figure 70. Vehicle Vertical Accelerometer Trace for Test 442882-4
(Accelerometer Located at Center of Gravity).**

X Acceleration Over Rear Axle



**Figure 71. Vehicle Longitudinal Accelerometer Trace for Test 442882-4
(Accelerometer Located Over Rear Axle).**

Y Acceleration Over Rear Axle

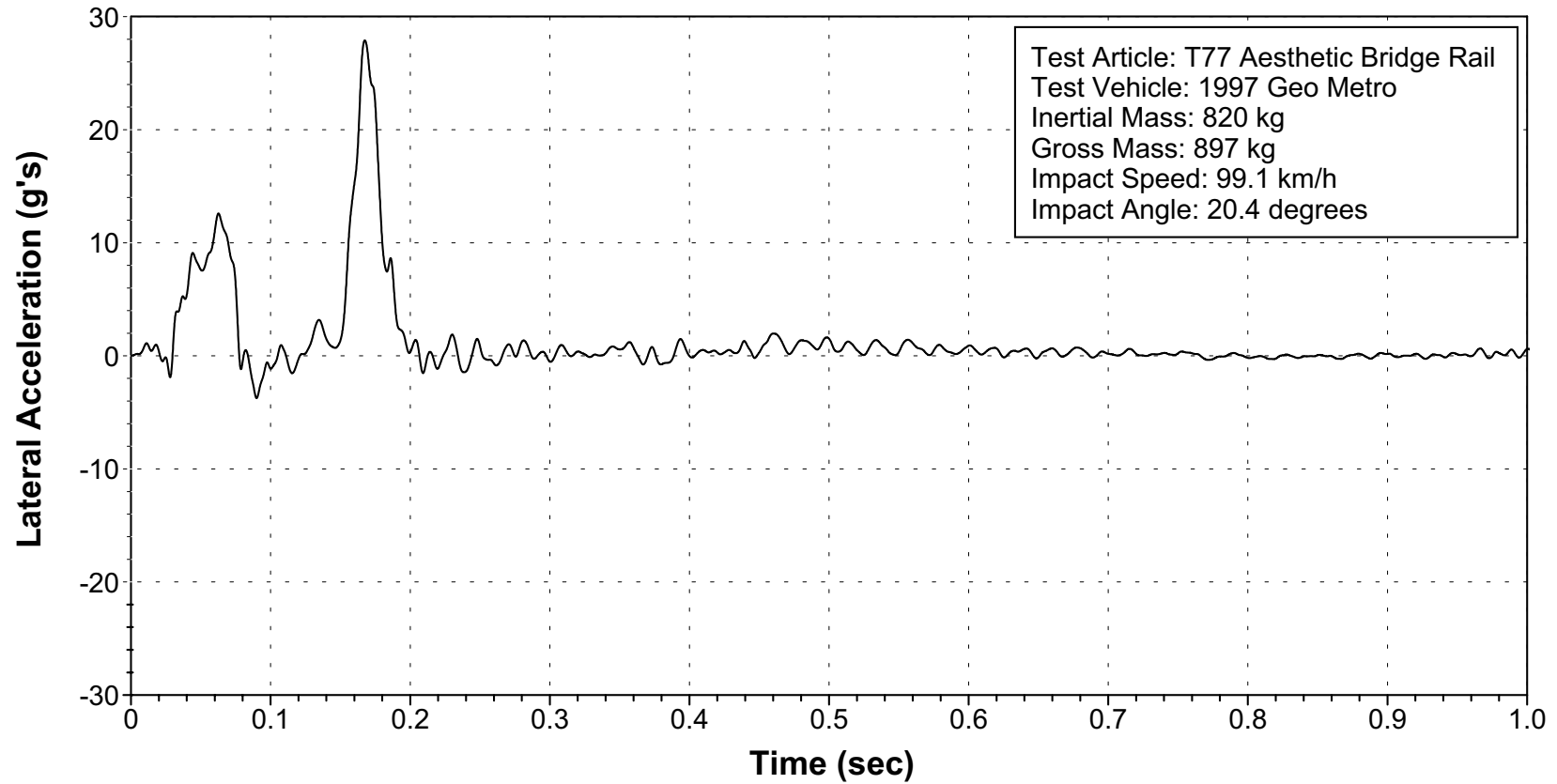
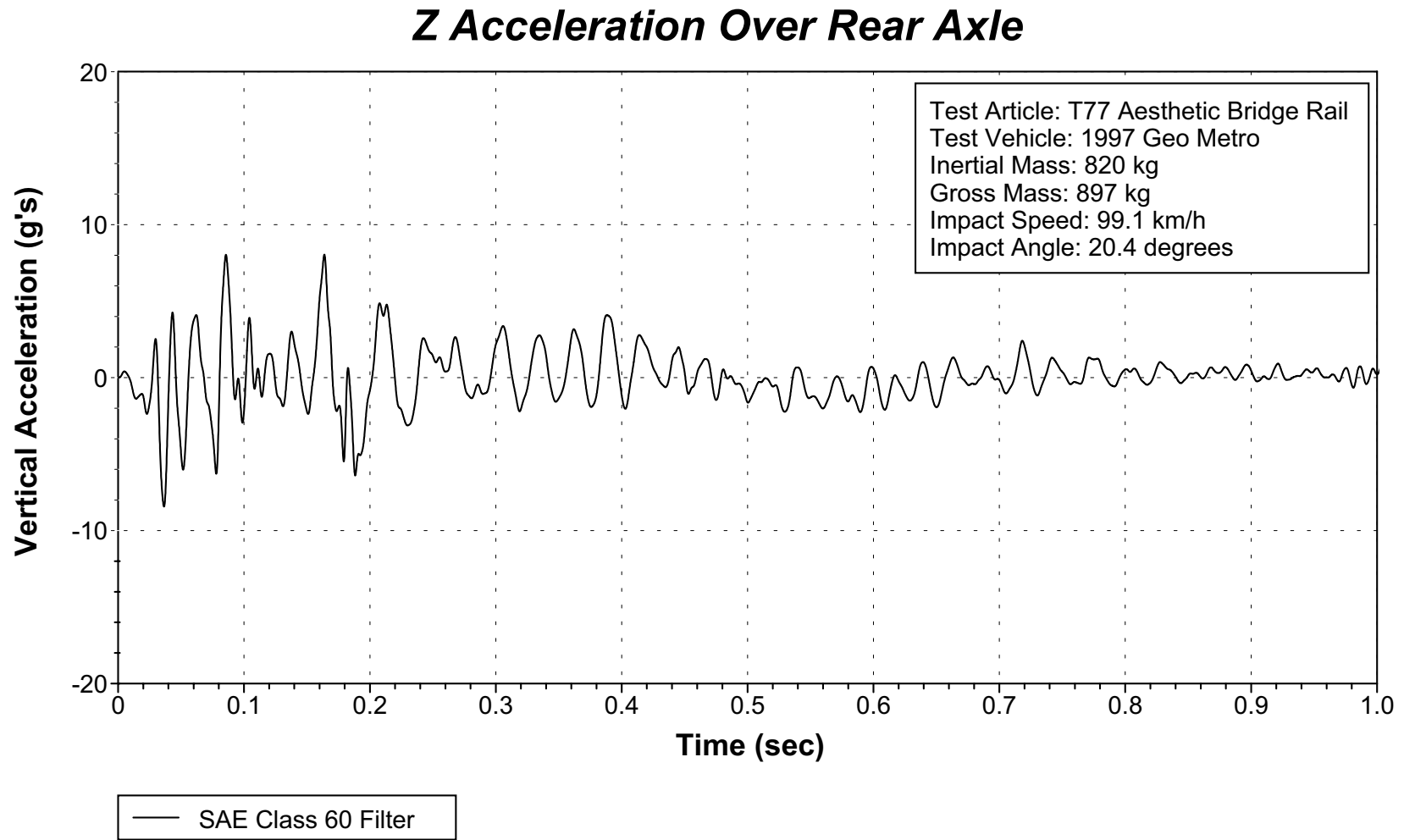


Figure 72. Vehicle Lateral Accelerometer Trace for Test 442882-4
(Accelerometer Located Over Rear Axle).



**Figure 73. Vehicle Vertical Accelerometer Trace for Test 442882-4
(Accelerometer Located Over Rear Axle).**