

**FULL-SCALE 18,000 LB. VEHICLE CRASH TEST  
ON THE  
IOWA RETROFIT CONCRETE  
BARRIER RAIL**

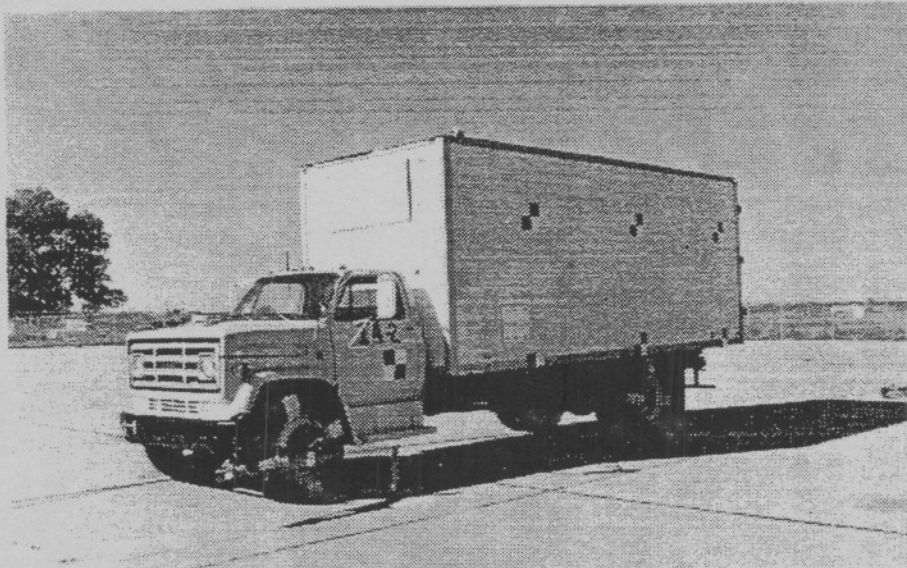

by

Mr. Brian G. Pfeifer, E.I.T.  
Assistant Research Engineer

Mr. James C. Holloway, E.I.T.  
Assistant Research Engineer

Mr. Ronald K. Faller, E.I.T.  
Research Associate Engineer

Dr. Edward R. Post, P.E.  
Professor of Civil Engineering

submitted to

Mr. William A. Lundquist, P.E.  
Bridge Engineer  
Iowa Department of Transportation

in cooperation with

Federal Highway Administration - Iowa Division

**TRANSPORTATION RESEARCH REPORT TRP-03-19-90**

Civil Engineering Department  
W348 Nebraska Hall  
University of Nebraska-Lincoln  
Lincoln, Nebraska  
68588-0531

January, 1990

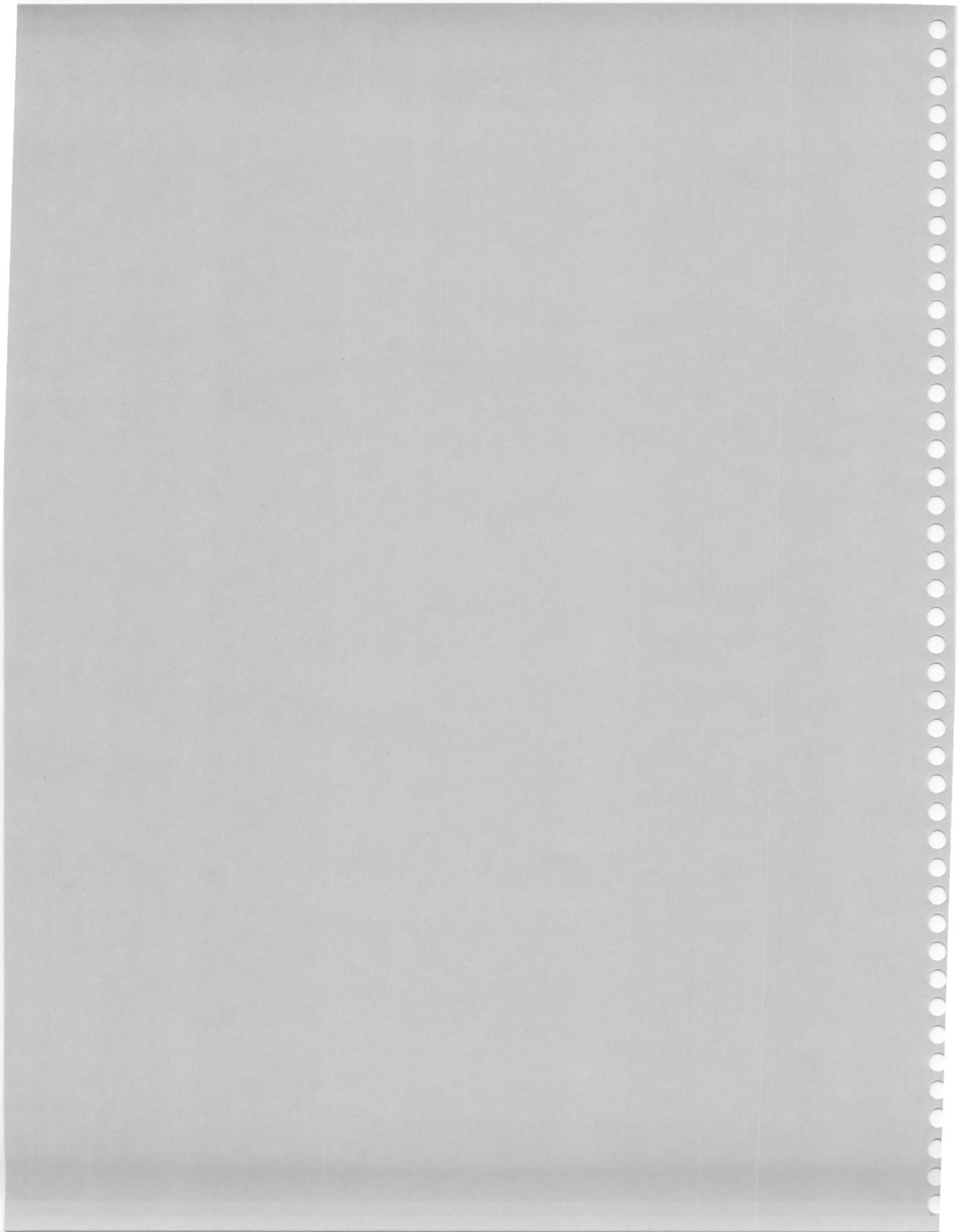

## DISCLAIMER STATEMENT

The contents of this report reflect the views of the authors who are responsible for the facts and the accuracy of the data presented herein. The contents do not necessarily reflect the official views or policies of the Iowa Department of Transportation or the Federal Highway Administration. This report does not constitute a standard, specification, or regulation.

retrofit concrete barrier rail section and 7 ft. of concrete endwall section on each end of the standard retrofit section. Two construction joints were located 35 ft. inward from both ends of the installation.

The tests were evaluated according to the safety criteria in the AASHTO guide specifications, performance level 2. The safety performance of the Iowa Retrofit Concrete Barrier Rail was determined to be satisfactory.



## TABLE OF CONTENTS

	Page
Abstract .....	i
Table of Contents .....	ii
List of Tables .....	iv
List of Figures .....	v
Acknowledgements .....	vi
1. INTRODUCTION .....	1
1.1. Problem Statement .....	1
1.2. Objective .....	2
2. TEST CONDITIONS .....	3
2.1. Test Facility .....	3
2.1.1. Test Site .....	3
2.1.2. Vehicle Tow System 3 .....	3
2.1.3. Vehicle Guidance System .....	4
2.2. Retrofit Concrete Barrier Design Details .....	9
2.3. Test Vehicle .....	15
2.4. Data Acquisition System .....	23
2.4.1. Accelerometers .....	23
2.4.2. High-Speed Photography .....	23
2.4.3. Speed Trap Switches .....	24
2.5. Test Parameters .....	29

	Page
3. PERFORMANCE EVALUATION CRITERIA .....	30
4. TEST RESULTS .....	33
4.1. Test I4-1 .....	33
4.2. Test I4-2 .....	39
5. CONCLUSIONS .....	45
6. RECOMMENDATIONS .....	49
7. REFERENCES .....	50
8. APPENDICES .....	51
Appendix A - Concrete Compressive Strengths .....	52
Appendix B - IDOT Correspondence .....	55
Appendix C - High-Speed Film Analysis .....	58

## LIST OF TABLES

	Page
1. Crash Test Conditions and Evaluation Criteria .....	31
2. Description of AASHTO Evaluation Criteria .....	32
3. AASHTO Evaluation Criteria .....	47
4. Summary of Test Results .....	48

## LIST OF FIGURES

	Page
1. Full-Scale Vehicle Crash Test Facility .....	5
2. Sketch of Cable Tow and Guidance Systems .....	6
3. Photographs of Tow Vehicles and Fifth Wheel .....	7
4. Photographs of Vehicle Guidance System .....	8
5. Photographs of the Iowa Retrofit Concrete Barrier Rail .....	11
6. Sketch of the Iowa Retrofit Concrete Barrier Rail .....	12
7. Photographs of Barrier Construction .....	13
8. Photographs of Barrier Construction .....	14
9. Photographs of Test Vehicle .....	17
10. Test Vehicle Dimensions .....	18
11. Location of Mass Centers .....	19
12. Ballast Construction .....	20
13. Photographs of Center of Mass Determination Using Suspension Method ..	21
14. Target Locations .....	22
15. Flowchart of Accelerometer Data Acquisition System .....	25
16. Photographs of Data Recorder and 386/AT Computer .....	26
17. Schematic of Camera Locations .....	27
18. Photographs of Speed Trap Switches .....	28
19. Test I4-1 Summary and Sequential Photos .....	35
20. Parallel Time-Sequential Photos, Test I4-1 .....	36

	Page
21. Photographs of Vehicle Damage, Test I4-1 .....	37
22. Retrofit Concrete Barrier Rail Damage, Test I4-1 .....	38
23. Test I4-2 Summary and Sequential Photos .....	41
24. Parallel Time-Sequential Photos, Test I4-2 .....	42
25. Photographs of Vehicle Damage, Test I4-2 .....	43
26. Retrofit Concrete Barrier Rail Damage, Test I4-2 .....	44

## **ACKNOWLEDGEMENTS**

The authors wish to express their appreciation and thanks to the following people who made a contribution to the outcome of this research project.

### **Iowa Department of Transportation**

This evaluation task was administered and directed by William A. Lundquist, Bridge Engineer for the Iowa Department of Transportation, who was assisted by IDOT Engineers David L. Little and Ron C. Welch.

### **Federal Highway Administration**

The Iowa Division Office of the Federal Highway Administration was represented by Bruce L. Brakke, Division Bridge Engineer, and John M. Latterell, Division Safety Engineer, who cooperated and advised during the evaluation.

### **Nebraska Department of Roads**

Dalyce Ronnau (Materials and Test Division Research Engineer)

### **University of Nebraska-Lincoln**

Ron Hoffman (Electrician - Maintenance)

Michael Cacak (Manager - Automobile Support Services)

Patrick Barrett (Assistant Manager - Automobile Support Services)

James Dunlap (Manager - Photographic Productions)

Gerald Fritz (E.E. Technician)

Tom Grady (E.E. Technician)



Tom Hoffman (Instrument Maker III)  
Jim McManis (Supervisor, Mechanical Engineering Shop)  
Edward Itzen (Instrument Maker III)  
Jack Somers (Instrument Maker III)  
William Kelly (Professor and C.E. Chairman)  
Eugene Matson (C.E. Research Technician)  
Syed Ataullah (C.E. Phd. Student)  
Wang Naitai (C.E. Phd Student)  
Mary Lou Tomka (C.E. Administrative Assistant)  
Wilma Ennenga (C.E. Research Analyst)  
Patricia Pederson (C.E. Secretary)

**Private**

Larry Storjahnn (Auto Buyer)  
Mike Collins (M.E. Collins Construction)  
Steve Buchanan (M.E. Collins Construction)  
Ron Hoffman (J.B. Truck Repair)  
John Magdaleno (Formerly at UNL, now at General Motors)

## 1. INTRODUCTION

### 1.1. Problem Statement

The Iowa Department of Transportation (IDOT) and the Federal Highway Administration (FHWA) are concerned with the safety and structural adequacy of highway and bridge railing systems installed on Iowa highways. The performance of certain Iowa railing systems now in service cannot be predicted or verified by conventional analysis.

Current AASHTO Standard Specifications for Highway Bridges permits the qualification of railing systems by full-scale vehicle crash testing. The Federal Highway Administration has directed that bridge railing systems be successfully crash tested before their use on Federal Aid Projects is approved.

The Iowa Retrofit Concrete Barrier Rail is currently constructed as a replacement bridge rail for bridges on the Iowa Primary and Interstate Systems. Thus, full-scale vehicle crash testing was to be performed to evaluate the structural adequacy, occupant risk, and redirection characteristics.

The results of this study will be used to help guide the IDOT in the identification and evaluation of current procedures in which to improve the safety of the roadway environment.

## 1.2. Objective of Study

The objective of the research study was to evaluate the safety performances of the Iowa Retrofit Concrete Barrier Rail by conducting full-scale vehicle crash tests in accordance with the "Recommended Procedures for the Safety Performance Evaluation of Highway Appurtenances", NCHRP 230 (1), and also in the "Guide Specifications for Bridge Railings," AASHTO (2).

The Iowa Retrofit Concrete Barrier Rail had been full-scale vehicle crash tested with the 1,800 lb. and the 5,400 lb. vehicles (3). Therefore, the barrier was to be full-scale vehicle crash tested with the 18,000 lb. vehicle to satisfy the PL-2 performance level in AASHTO (2).

## 2. TEST CONDITIONS

### 2.1. Test Facility

#### 2.1.1. Test Site

The test facility was located at Lincoln Air-Park on the Northwest end of the west apron of the Lincoln Municipal Airport. The test facility, shown in Figure 1, is approximately 5 miles Northwest of the University of Nebraska-Lincoln.

An 8 ft. high chain-link security fence surrounds the test facility to prevent vandalism to the test articles and vehicles, which could possibly disrupt the results of the test.

#### 2.1.2. Vehicle Tow System

A reverse cable tow, with a 1:2 mechanical advantage, was used to propel the test vehicle. The distance traveled and the speed of the tow vehicle are one-half of that of the test vehicle. A sketch of the cable tow system is shown in Figure 2. In both tests the test vehicle was released from the tow cable approximately 30 ft. before impact with the Retrofit Concrete Barrier Rail. Photographs of the tow vehicles and the attached fifth-wheel are shown in Figure 3.

The fifth-wheel, built by the Nucleus Corporation, with the aid of a digital speedometer in the tow vehicle, was used to accurately measure the speed of the test vehicle.

### **2.1.3. Vehicle Guidance System**

A vehicle guidance system, developed by Hinch (4), was used to steer the test vehicle. Photographs of the guidance system are shown in Figure 4, and a sketch of the guidance system is shown in Figure 2. The guide-flag, attached to the front left wheel and the guide cable, was sheared off 30 ft. before impact with the Retrofit Concrete Barrier Rail. The 3/8 in. diameter guide cable was tensioned to 3000 lbs., and was supported laterally and vertically every 100 ft. by hinged stanchions. The hinged stanchions stood upright while holding up the guide cable. As the test vehicle passed each stanchion, the attached guide flag struck the stanchions, knocking them to the ground. The test vehicle guidance cable was approximately 2000 ft. in length.

## 2. TEST CONDITIONS

### 2.1. Test Facility

#### 2.1.1. Test Site

The test facility was located at Lincoln Air-Park on the Northwest end of the west apron of the Lincoln Municipal Airport. The test facility, shown in Figure 1, is approximately 5 miles Northwest of the University of Nebraska-Lincoln.

An 8 ft. high chain-link security fence surrounds the test facility to prevent vandalism to the test articles and vehicles, which could possibly disrupt the results of the test.

#### 2.1.2. Vehicle Tow System

A reverse cable tow, with a 1:2 mechanical advantage, was used to propel the test vehicle. The distance traveled and the speed of the tow vehicle are one-half of that of the test vehicle. A sketch of the cable tow system is shown in Figure 2. In both tests the test vehicle was released from the tow cable approximately 30 ft. before impact with the Retrofit Concrete Barrier Rail. Photographs of the tow vehicles and the attached fifth-wheel are shown in Figure 3.

The fifth-wheel, built by the Nucleus Corporation, with the aid of a digital speedometer in the tow vehicle, was used to accurately measure the speed of the test vehicle.



### **2.1.3. Vehicle Guidance System**

A vehicle guidance system, developed by Hinch (4), was used to steer the test vehicle. Photographs of the guidance system are shown in Figure 4, and a sketch of the guidance system is shown in Figure 2. The guide-flag, attached to the front left wheel and the guide cable, was sheared off 30 ft. before impact with the Retrofit Concrete Barrier Rail. The 3/8 in. diameter guide cable was tensioned to 3000 lbs., and was supported laterally and vertically every 100 ft. by hinged stanchions. The hinged stanchions stood upright while holding up the guide cable. As the test vehicle passed each stanchion, the attached guide flag struck the stanchions, knocking them to the ground. The test vehicle guidance cable was approximately 2000 ft. in length.

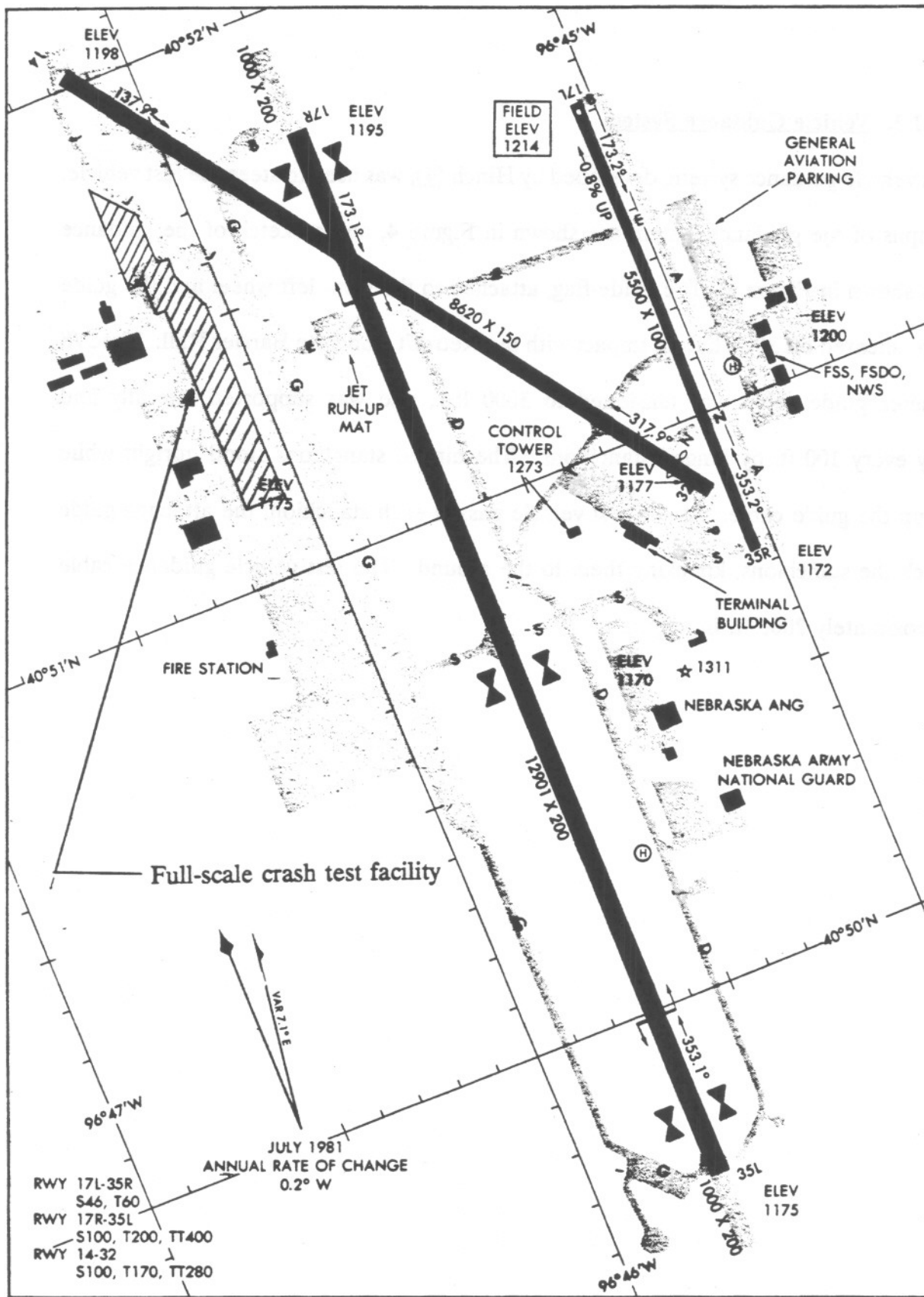

Figure 1. Full-scale crash test facility.

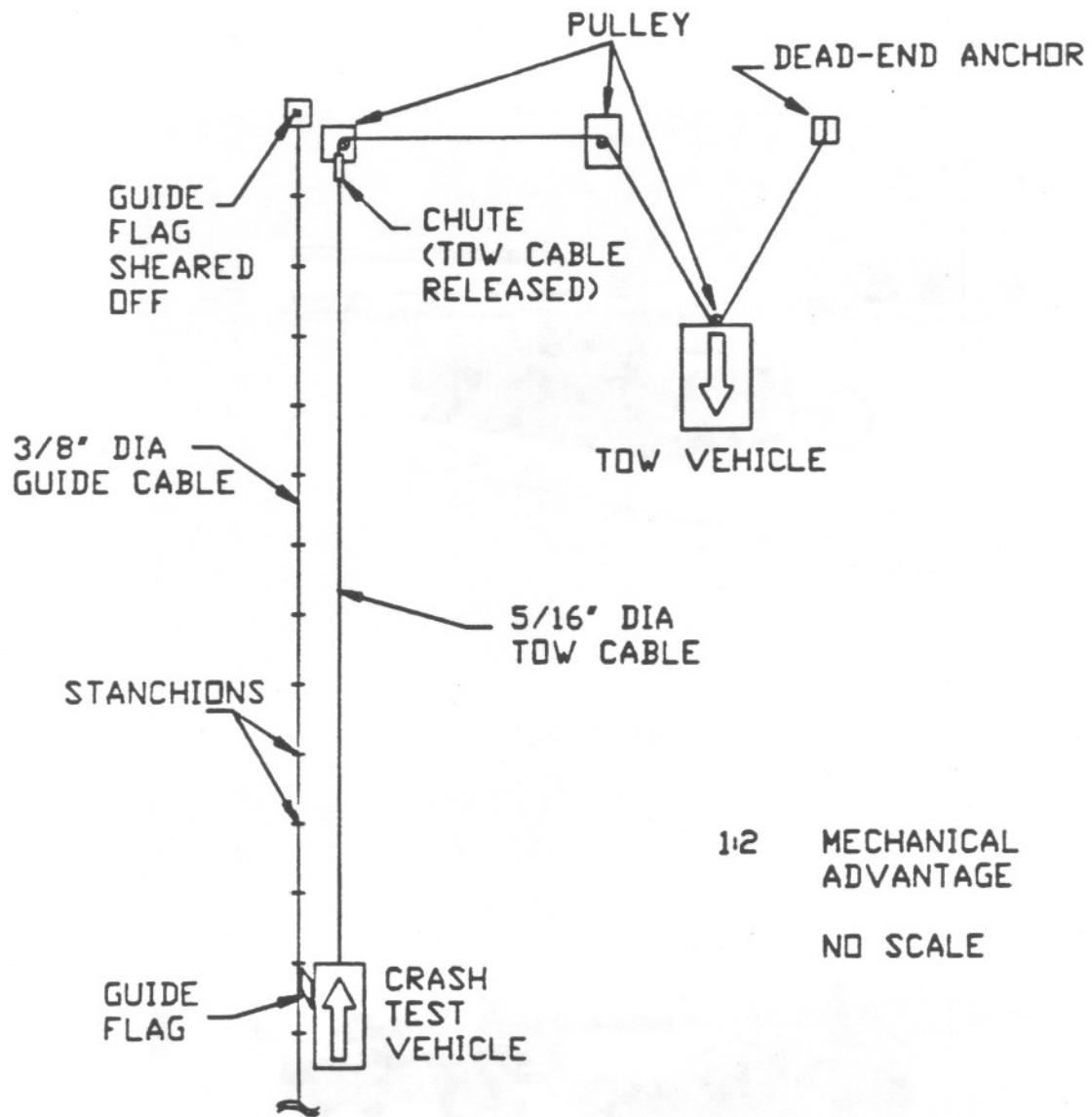
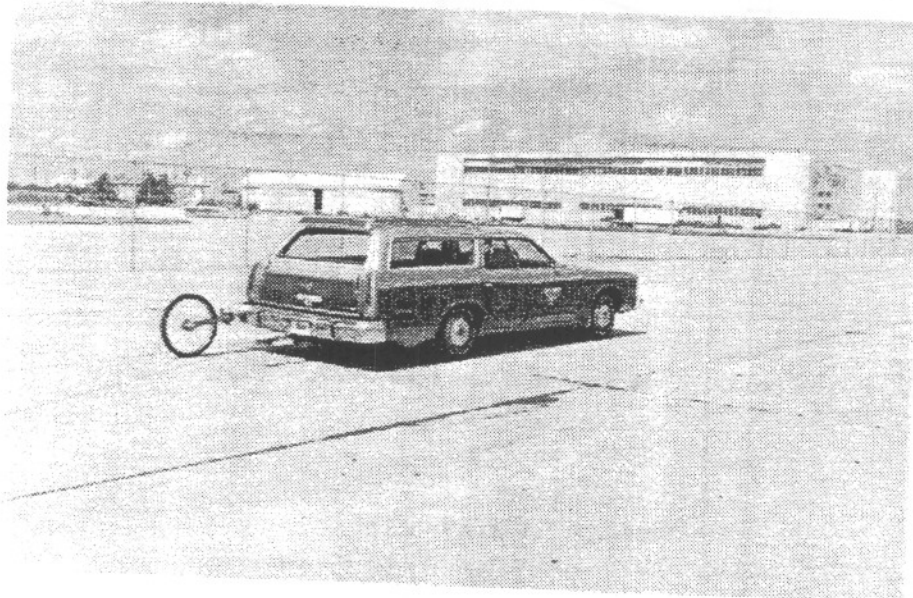
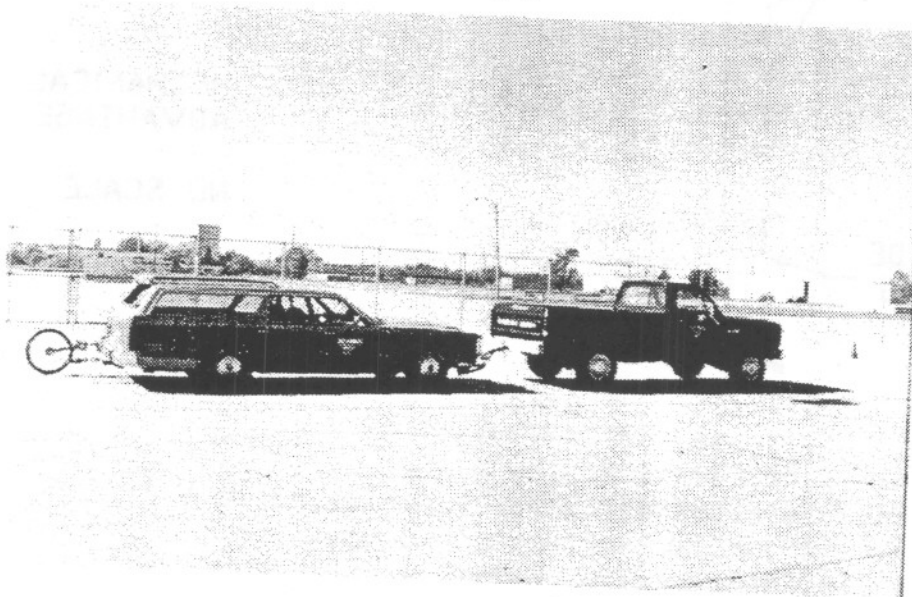

Figure 2. Sketch of cable tow and guidance systems.



TEST I4-1



TEST I4-2

Figure 3. Photographs of tow vehicles and fifth wheel.

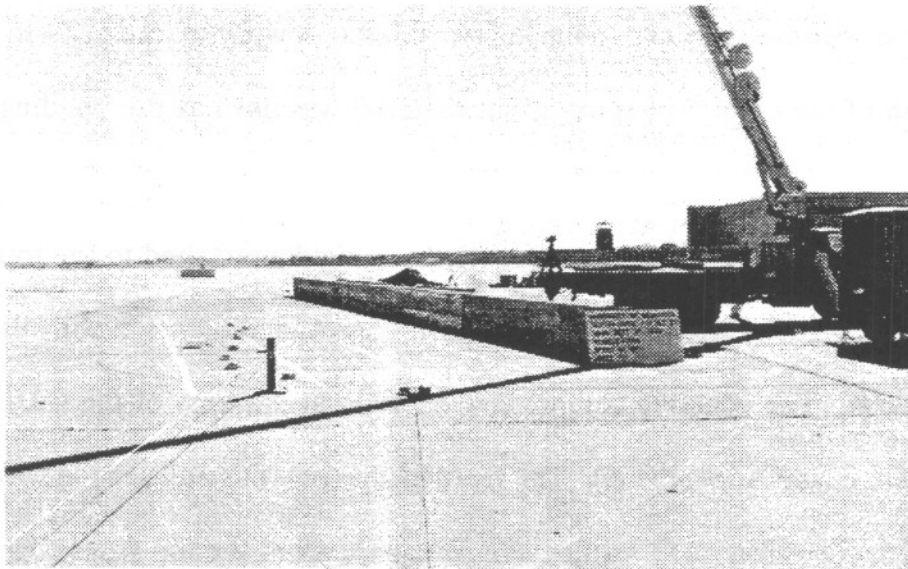
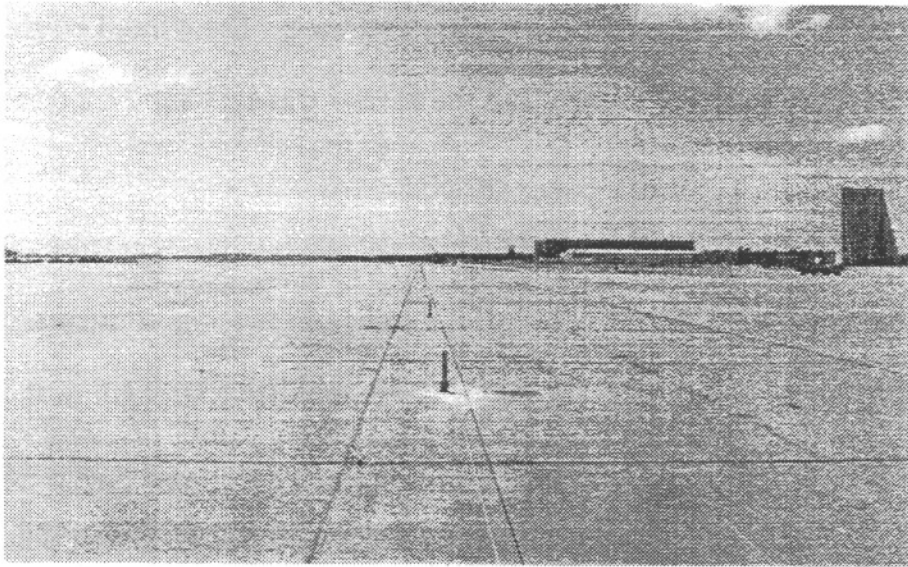
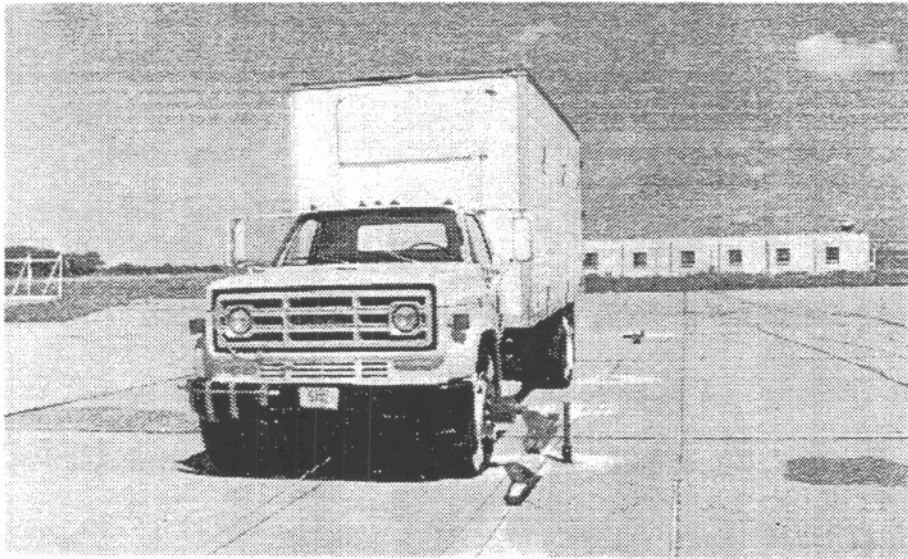

Figure 4. Photographs of vehicle guidance system.

## **2.2. Retrofit Concrete Barrier Design Details**

An overall view of the Iowa Retrofit Concrete Barrier Rail is shown in the photographs in Figure 5 and a detailed drawing is shown in Figure 6. The total length of the installation was 100 ft. It consisted of 86 ft. of standard retrofit concrete barrier rail section and 7 ft. of concrete end wall section on each end of the standard retrofit section. The bridge rail consisted of three major components: the existing concrete curb, the rectangular (retrofit) concrete wall section, and the concrete end walls. The overall height of the barrier was 32-in. above the roadway surface, and the barrier was set back 3-in. from the curb face.

The existing concrete curb remained from the full-scale vehicle crash tests performed on the Iowa Box-Aluminum Bridge Rail (5). The 12-in. high concrete curb was constructed with a Nebraska Class "47-B-PHE" design mix. The concrete compressive strength at the time of the crash tests (for the Box-Aluminum Bridge Rail) averaged about 6,000 psi (see Appendix A). The curb was 20-in. wide and 86 ft. in length. The curb was anchored 8-in. into the existing airport concrete apron by two L-shaped No. 5 rebar dowels, spaced at 14-in. on centers over the length of the curb. An epoxy grout material was used as the bonding agent for the dowels.

The 86 ft. rectangular (retrofit) concrete wall section was rigidly attached to the top of the existing 12-in. high concrete curb. The wall was also constructed with a Nebraska Class "47-B-PHE" design mix. The concrete compressive strength at the time of the crash tests averaged above 6,000 psi (see Appendix A). The rectangular concrete wall section was 10-in. wide and 20-in. high. The front face was located 3-in. back from the top front edge



of the existing concrete curb. This dimension may vary from 1-in. to 3-in. on existing installations. The rectangular concrete wall section was anchored 10-in. into the existing concrete curb by two vertical No. 6 rebar dowels, staggered at 15-in. on centers over the length of the wall section. An epoxy grout material was used as the bonding agent for the dowels. The rectangular concrete wall section was constructed with two construction joints located 28 ft. from each end of the 86 ft. section.

The 7 ft. concrete end walls were also constructed with the Nebraska concrete design mix and had the same concrete compressive strengths as the wall section (see Appendix A). The endwalls were rigidly anchored to the existing airport concrete apron by the existing, two No. 5 vertical dowels spaced at 13-in. on centers over the length of the end wall. An epoxy grout material was used as the bonding agent for dowels.

Photographs of the construction process are shown in Figures 7 and 8.

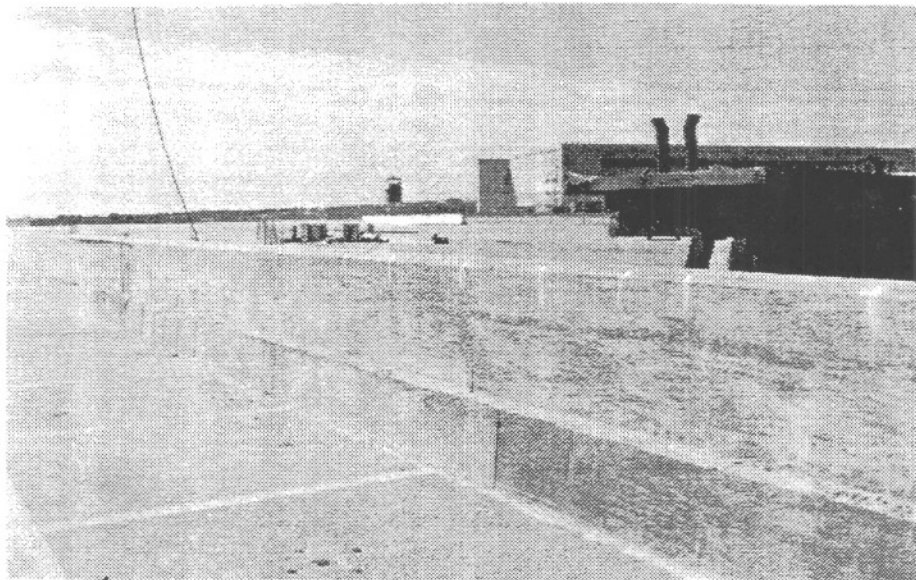
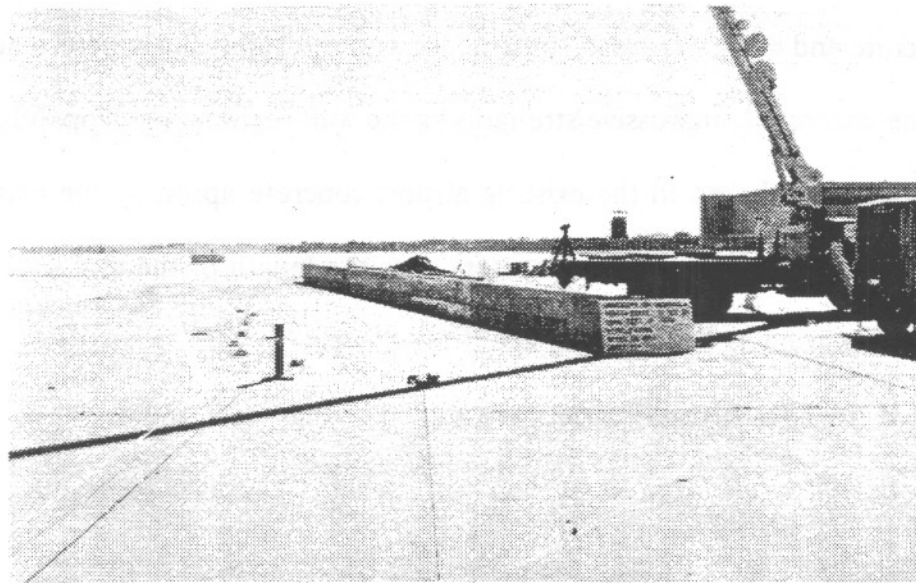
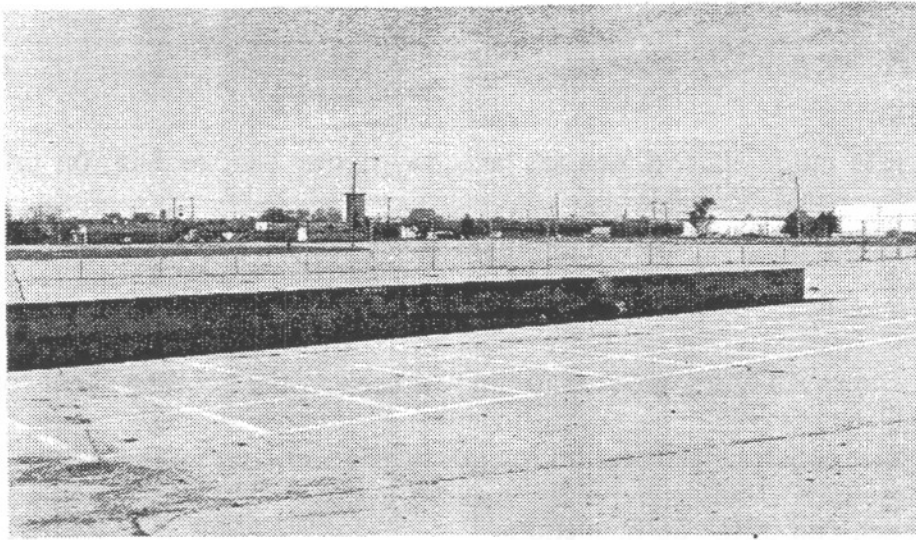
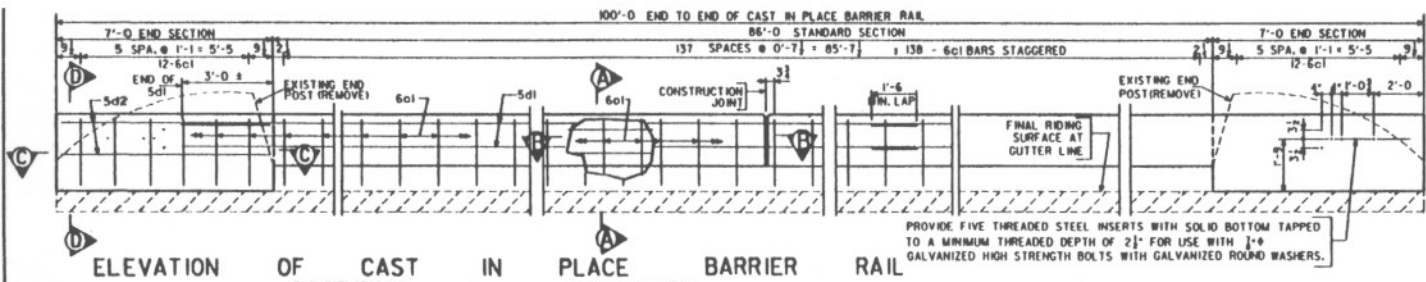

Figure 5. Photographs of the Iowa Retrofit Concrete Barrier Rail.



**EPOXY REINFORCING STEEL - ONE RAIL**

BAR	LOCATION	SHAPE	N <sup>o</sup> .	LENGTH	WEIGHT
6c1	RAIL, VERTICAL		162	2'-4"	568
5d1	STANDARD SECTION, LONGIT.		12	31'-8"	396
5d2	END SECTION, LONGIT.		8	6'-8"	56
TOTAL (lbs.)					1020

**CONCRETE PLACEMENT SUMMARY**

SECTION	TOTAL
END SECTIONS	2 @ 1.0 CU.YDS. PER SECTION = 2.0
STANDARD SECTION	86.0 L.F. @ 0.05 CU.Y./L.F. = 4.3
TOTAL (CU.YDS.)	6.3

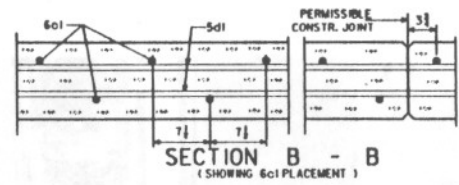
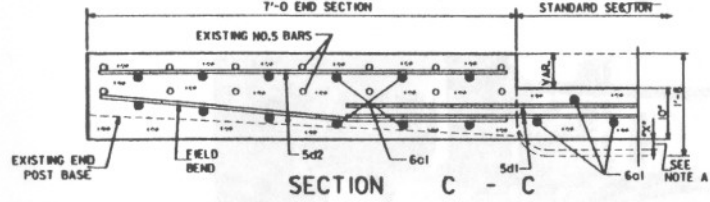

**CAST IN PLACE BARRIER RAIL NOTES:**

MINIMUM CLEAR DISTANCE FROM FACE OF CONCRETE TO NEAR REINFORCING BAR IS TO BE 2" UNLESS OTHERWISE NOTED OR SHOWN.

ALL EXPOSED CORNERS 90° OR SHARPER ARE TO BE FILLETED WITH A 1/2" DRESSED AND BEVELED STRIP.

CONSTRUCTION JOINTS ARE TO BE PLACED BETWEEN VERTICAL BARS. CONSTRUCTION JOINT CONTACT SURFACES ARE TO BE COATED WITH AN APPROVED BOND BREAKER.

ALL CAST IN PLACE BARRIER RAIL CONCRETE IS TO BE CLASS D.

ALL REINFORCING STEEL IS TO BE GRADE 60.

THE JOINT SEALER SHALL CONFORM TO FED. SPEC. TT-S00230 OR TT-S00227 FOR TYPE II, CLASS A OR B.

12

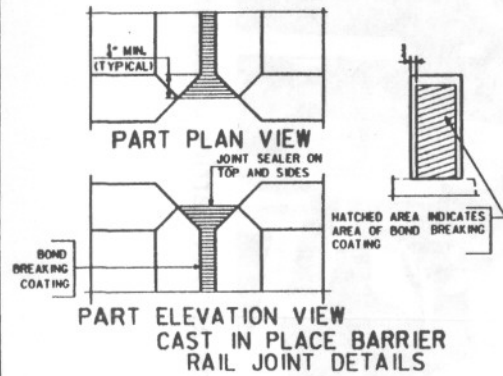
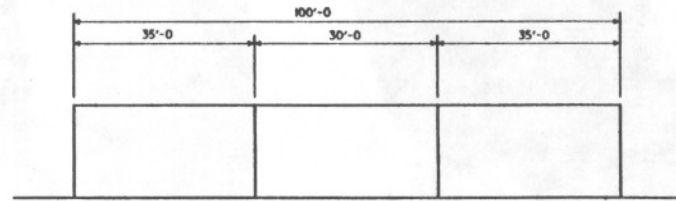
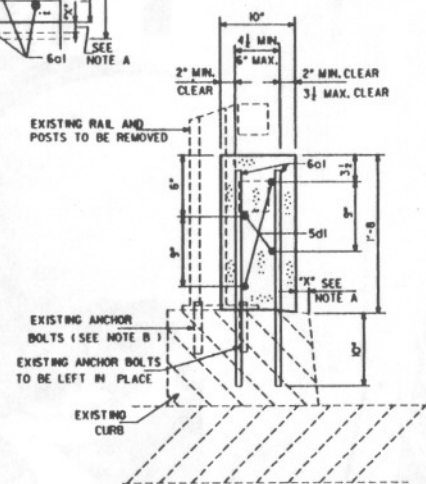
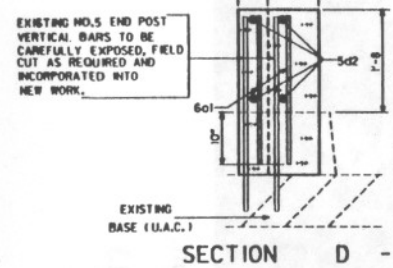

**NOTE B:**

EXISTING RAILS, RAIL POSTS, CONCRETE END POSTS SHALL BE REMOVED.

THE EXISTING ANCHOR BOLTS MAY BE LEFT IN PLACE AT THE CONTRACTOR'S OPTION SUBJECT TO APPROVAL OF THE ENGINEER.

**DOVEL SETTING NOTE:**

THE 6c1 BARS SHALL BE SET AS DOVELS IN DRILLED HOLES. HOLES ARE TO BE 10" DEEP, THE DOVELS SHALL BE INSTALLED IN ACCORDANCE WITH THE MANUFACTURER'S RECOMMENDATIONS.

EPOXY GROUT SYSTEM IN ACCORDANCE WITH STANDARD SPECIFICATIONS ARTICLE 230.15 SHALL BE USED.

REVISION 08-17-88:

GROUTING SYSTEM SPECIFIED FOR DOVELS. CONSTRUCTION JOINT SPACING SPECIFIED. DIMENSION "X" SET AT 3".

**CRASH TEST**

PROJECT BRP-0005(2)-38-00

**TASK N<sup>o</sup> 2**

**APPENDIX A**

PROJECT SHEET 3 of 4

IOWA DEPARTMENT OF TRANSPORTATION - HIGHWAY DIVISION

DESIGN SHEET NO. \_\_\_\_\_ OF \_\_\_\_\_ FILE NO. \_\_\_\_\_ DESIGN NO. \_\_\_\_\_

DESIGNED BY _____	TRACED BY _____	CAST IN PLACE BARRIER RAIL	STANDARD SHEET 1031A	COUNTY _____	PROJECT NUMBER _____	STATE IOWA	SECTION 7	DATE _____	SCALE _____	BY _____	DATE _____
-------------------	-----------------	----------------------------	----------------------	--------------	----------------------	------------	-----------	------------	-------------	----------	------------

HCRA5H.2 DEVICE # ZGAM200,003 ARCH. TAPE No. \_\_\_\_\_ DATE \_\_\_\_\_

Figure 6. Sketch of the Iowa Retrofit Concrete Barrier Rail.

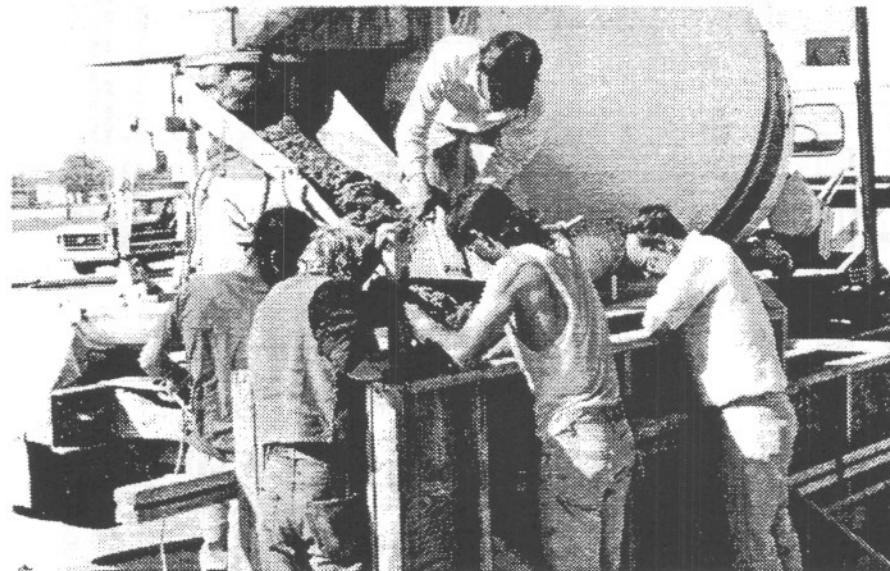
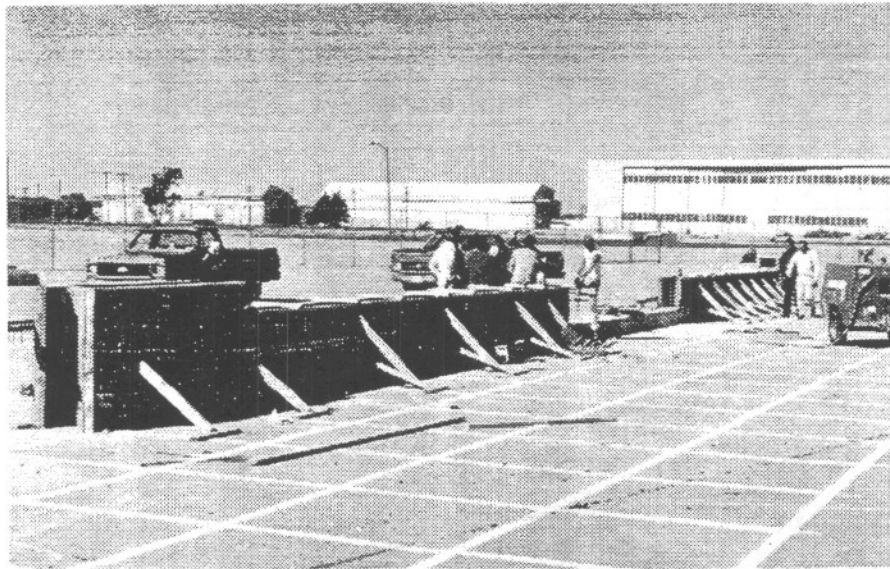
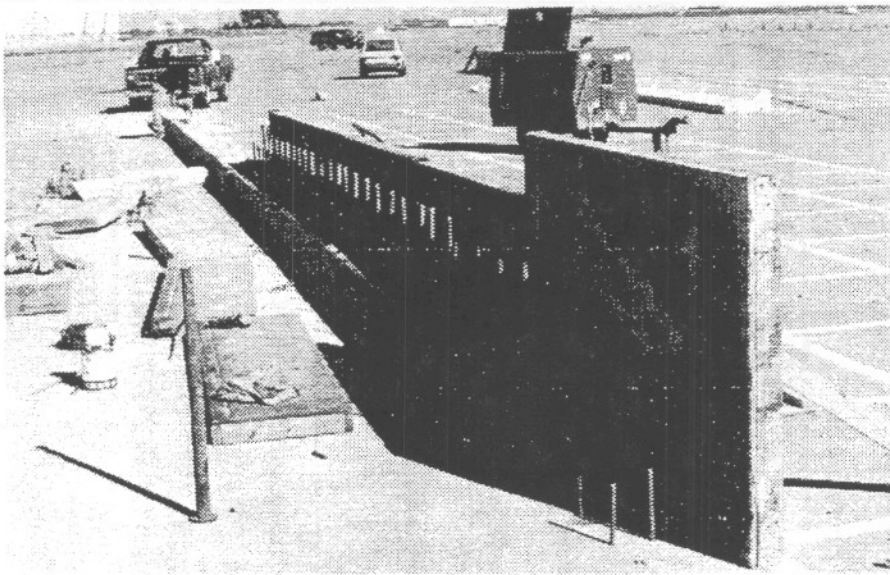

Figure 7. Photographs of barrier construction.



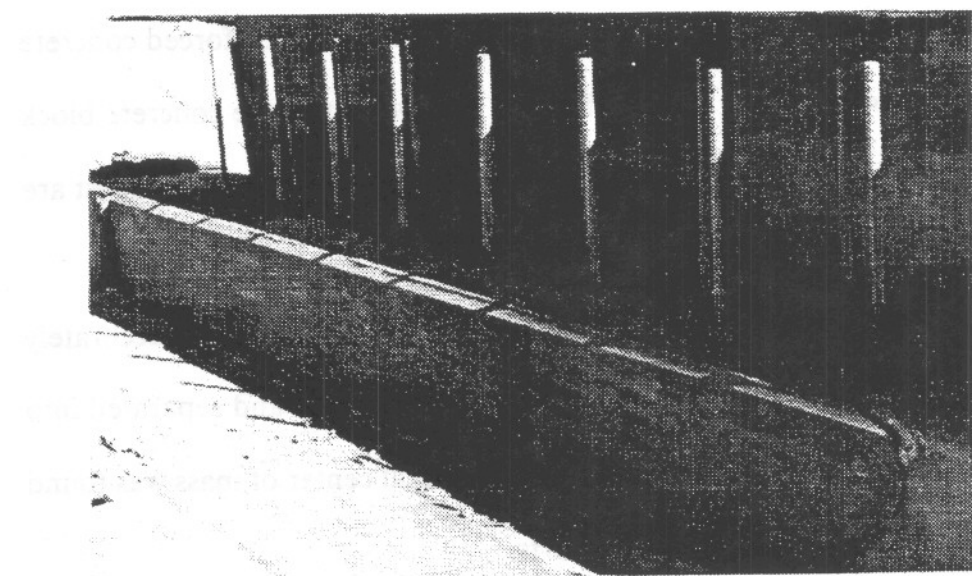
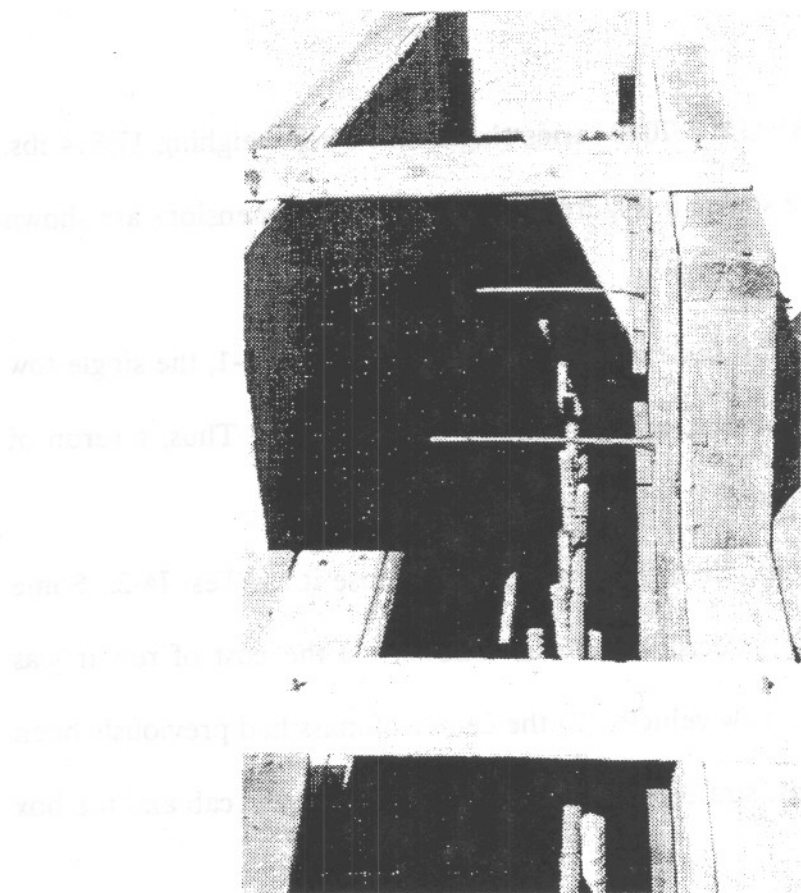

Figure 8. Photographs of barrier construction.

### 2.3. Test Vehicle

The test vehicle was a 1983 GMC 7000 series single-unit truck weighing 17,814 lbs. Photographs of the test vehicle are shown in Figure 9, and the vehicle dimensions are shown in Figure 10.

The same vehicle was used for Tests I4-1 and I4-2. During Test I4-1, the single tow vehicle was unable to get the test vehicle to the required impact speed. Thus, a rerun of the first test, Test I4-2, was performed.

The decision was made to rebuild the test vehicle and reuse it for Test I4-2. Some of the factors which influenced this decision were as follows: (1) the cost of repair was approximately half of the cost for a new vehicle, (2) the center of mass had previously been accurately calculated and the ballast strategically located, and (3) both the cab and the box received only minor damage.

The ballast was located according to the center-of-mass specification in AASHTO (2). The location of the ballast is shown in Figure 11. It consisted of a reinforced concrete block which was bolted to the walls and floor of the box. The weight of the concrete block was approximately 5100 lbs. Photographs of the location and construction of the ballast are shown in Figure 12.

The center-of-mass was calculated by two different methods in order to accurately locate the ballast. First the truck was treated as a composite rigid body and separated into three parts: (1) cab and frame, (2) box, and (3) ballast. The total center of mass was found by combining the centers-of-mass of the separate parts.

Secondly, the Suspension Method (6) was used as a check on the static method. The Suspension Method is based on the principle that the center of gravity of any freely suspended body is in the vertical plane through the point of suspension. The vehicle was successively suspended in three positions, and the respective planes containing the center of gravity were established. The intersection of these planes located the center of gravity. Photographs of the suspension process are shown in Figure 13.

Twelve, 12-in. square, black and white checkered targets were placed on the vehicle. These targets were used in the high speed film analysis. Two targets were located on the center-of-mass, one on the top and one on the side of the test vehicle. The remaining targets were located such that they could be used by both the perpendicular and overhead cameras. Stripes were also painted on the tires to indicate tire rotation. Dimensions of target locations are shown in Figure 14.

Four 5B flash bulbs were mounted on the roof of the box in order to record the time of impact with the barrier rail on the high speed film. The flash bulbs were fired by a pressure tape switch mounted on the front face of the test vehicle's bumper.

The front wheels of the test vehicle were aligned to a toe-in value of zero-zero so that the vehicle would track properly along the guide cable.

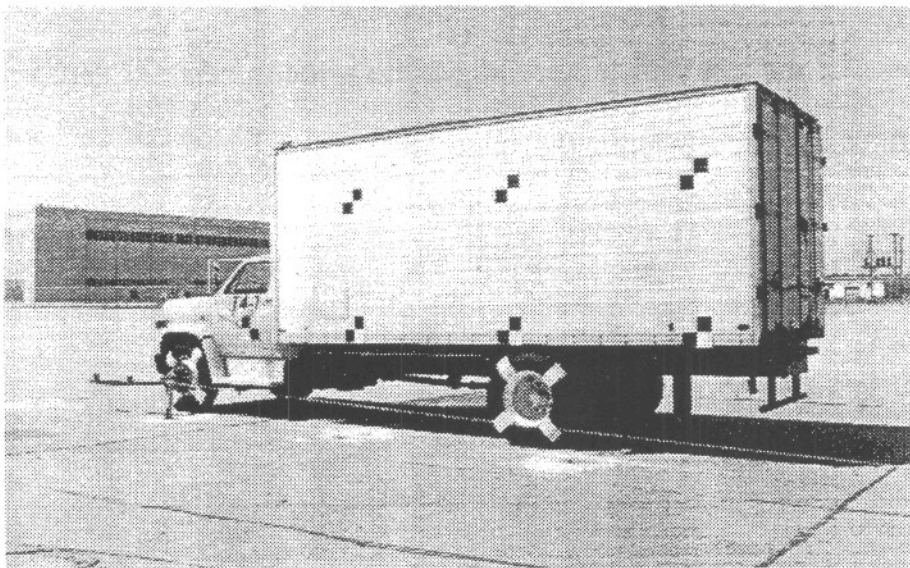
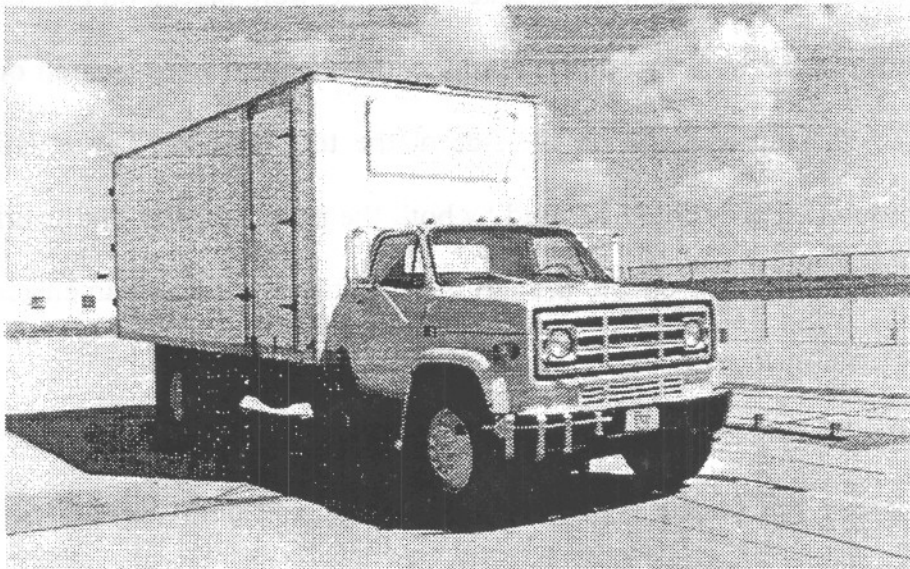
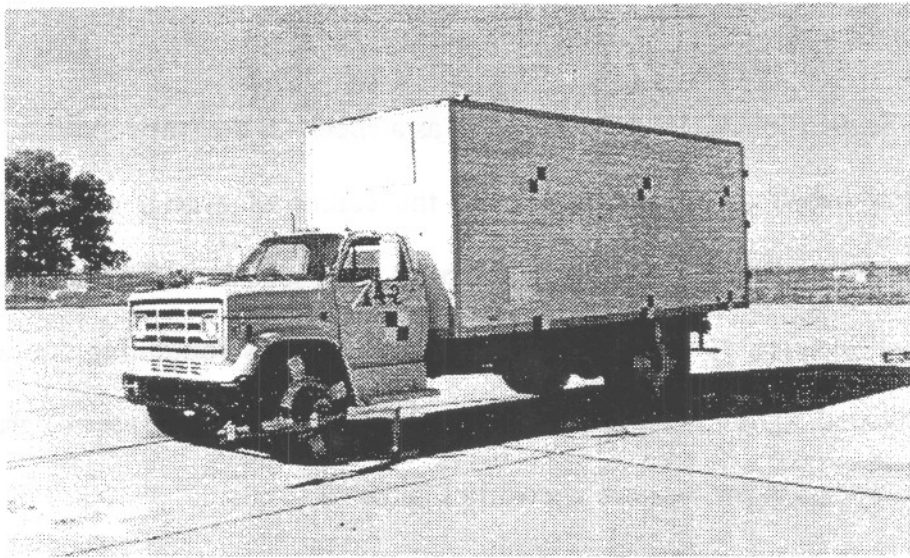
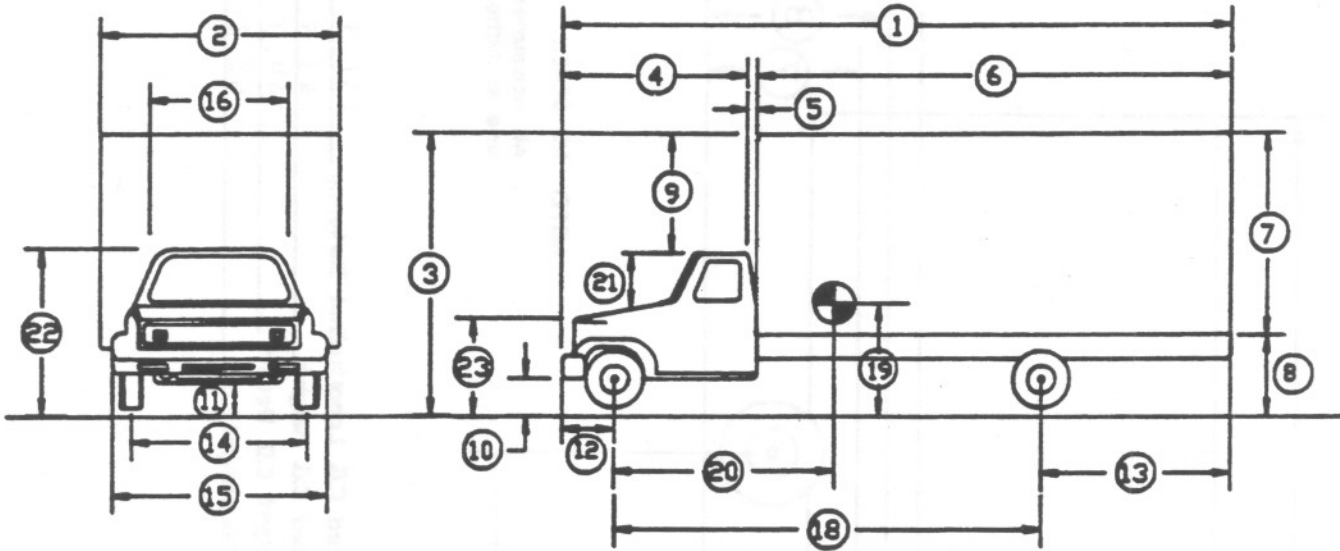

Figure 9. Photographs of test vehicle.



**VEHICLE DIMENSIONS  
FOR 18,000 LB.  
SINGLE UNIT TRUCK**



Model 1983 GMC 7000 Series

Total Weight 17,814 lb.

Front Weight 5,052 lb.

Rear Axle Weight 7,648 lb.

Ballast 5,114 lb.

① Overall Length <u>351.5</u>	⑬ Rear Overhang <u>100.0</u>
② Overall Width <u>96.0</u>	⑭ Front Track Width <u>76.0</u>
③ Overall Front Height <u>136.0</u>	⑮ Front Bumper Width <u>89.5</u>
④ Cab Length <u>97.0</u>	⑯ Roof Width <u>58.0</u>
⑤ Gap Length <u>7.5</u>	⑰ Typical Tire Size and Diameter <u>39.5</u>
⑥ Trailer/Box Length <u>247.0</u>	⑱ Wheel Base <u>218</u>
⑦ Rear Body Height <u>97.5</u>	⑲ C.G. Height <u>49.0</u>
⑧ Rear Ground Clearance <u>38.5</u>	⑳ C.G. Longitudinal Distance <u>125.6</u>
⑨ Roof Height Differential <u>49.0</u>	㉑ Roof-Hood Distance <u>22.5</u>
⑩ Front Ground Clearance <u>20.0</u>	㉒ Roof Height <u>87.0</u>
⑪ Minimum Ground Clearance <u>12.0</u>	㉓ Hood Height <u>64.5</u>
⑫ Front Overhang <u>28.0</u>	

NOTE: NO SCALE  
All measurements are in inches.

Figure 10. Test vehicle dimensions.

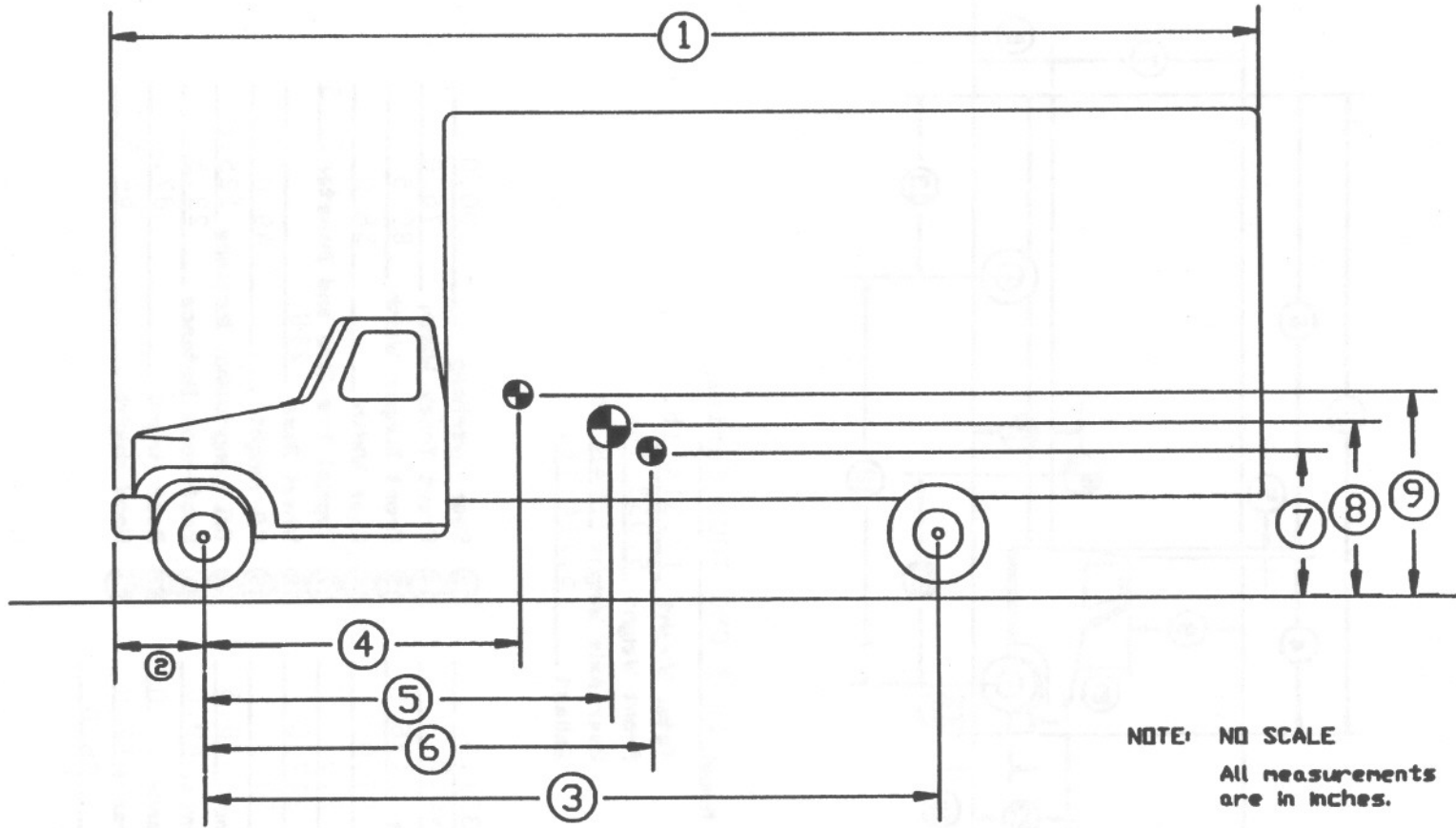

NOTE: NO SCALE  
All measurements are in inches.

① Overall Length	_____	351.5
② Front Overhang	_____	28.0
③ Wheel Base	_____	218.0
④ Ballast C.G. Longitudinal Distance	_____	112.2
⑤ Total Weight C.G. Longitudinal Distance	_____	125.6

⑥ Unballasted C.G. Longitudinal Distance	_____	131.3
⑦ Unballasted C.G. Height	_____	43.5
⑧ Total Weight C.G. Height	_____	49.0
⑨ Ballast C.G. Height	_____	62.2

Figure 11. Location of mass centers.

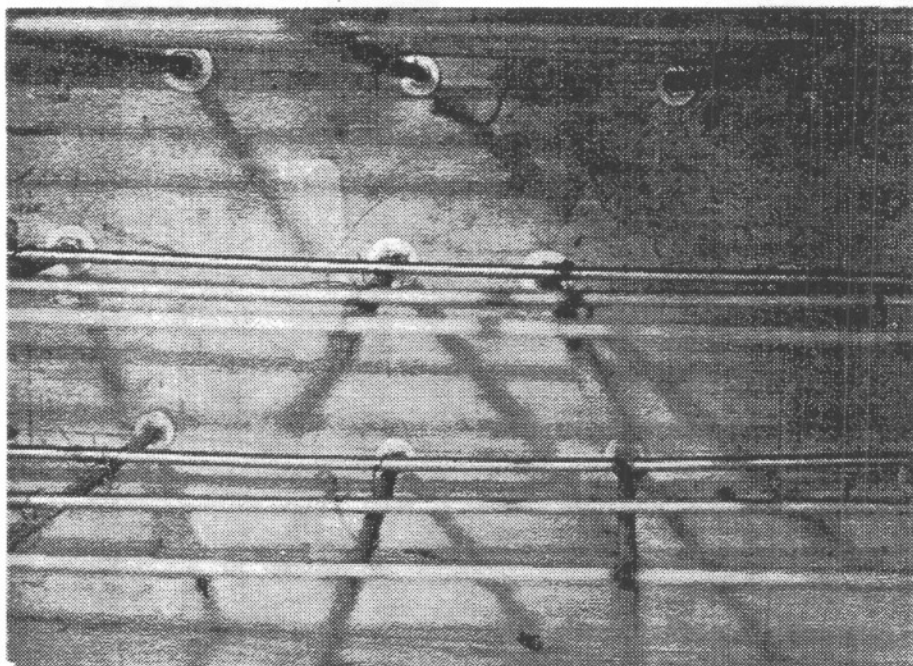
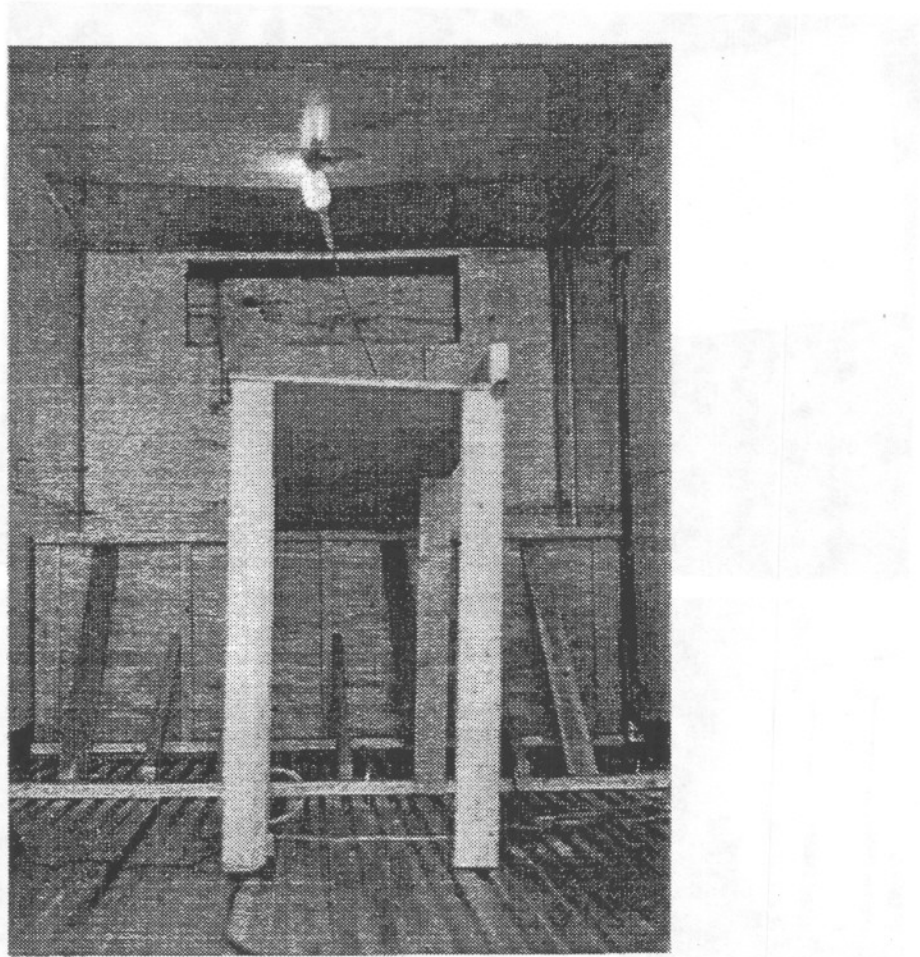

Figure 12. Ballast construction.

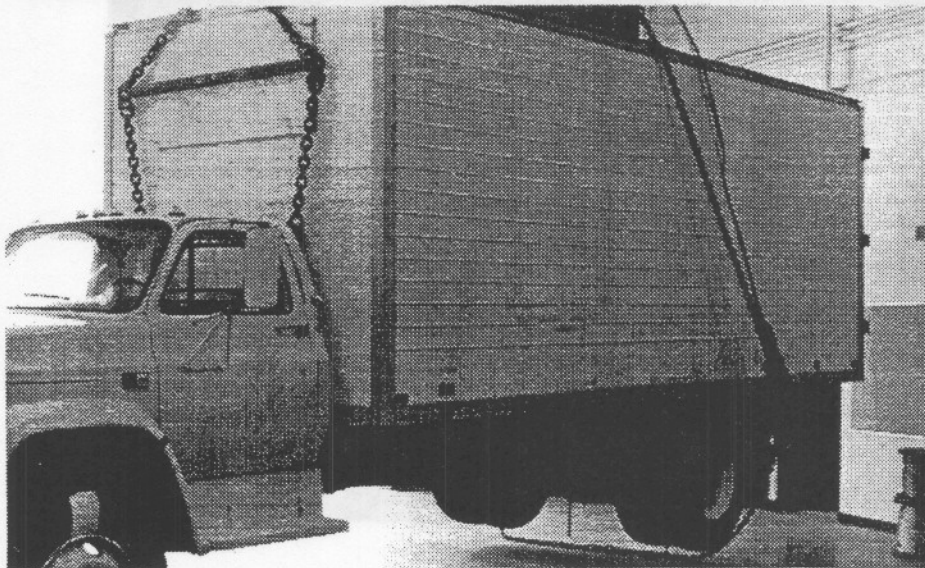
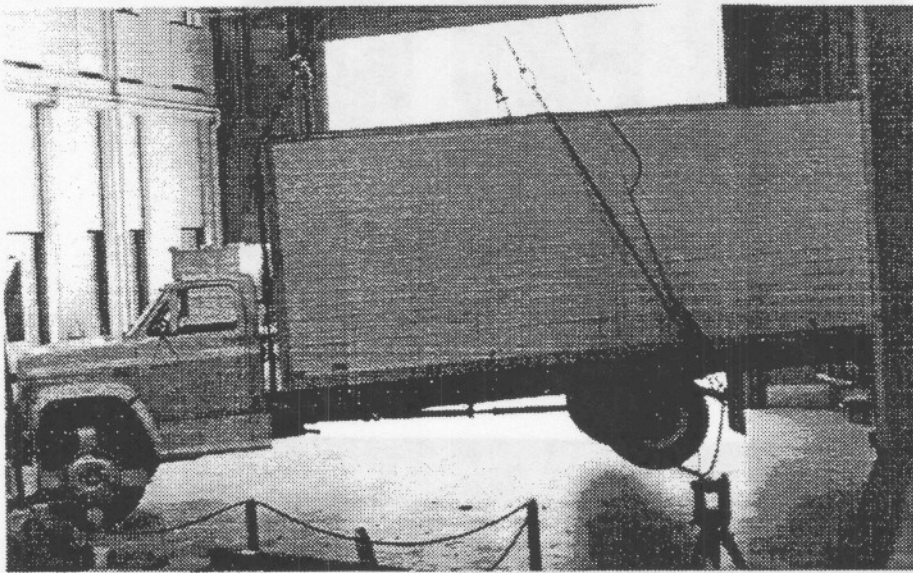
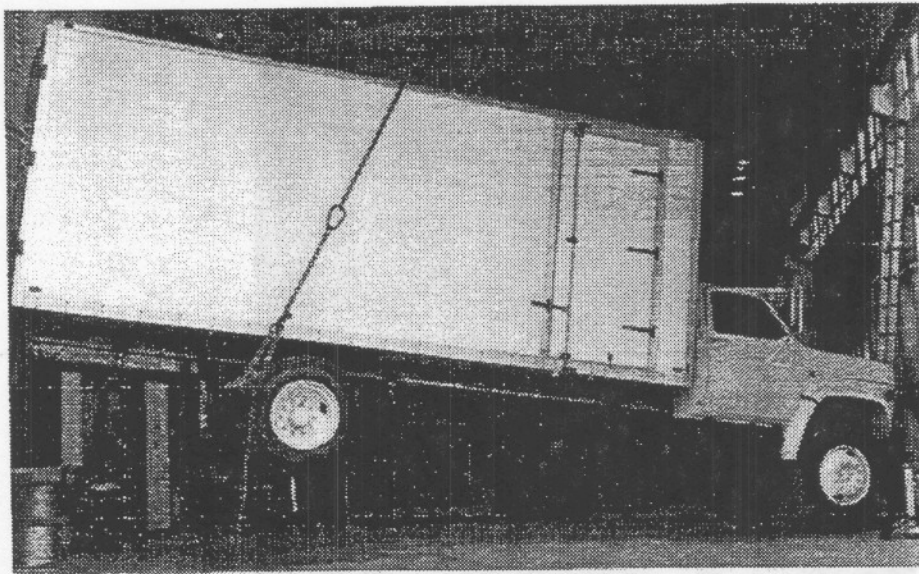
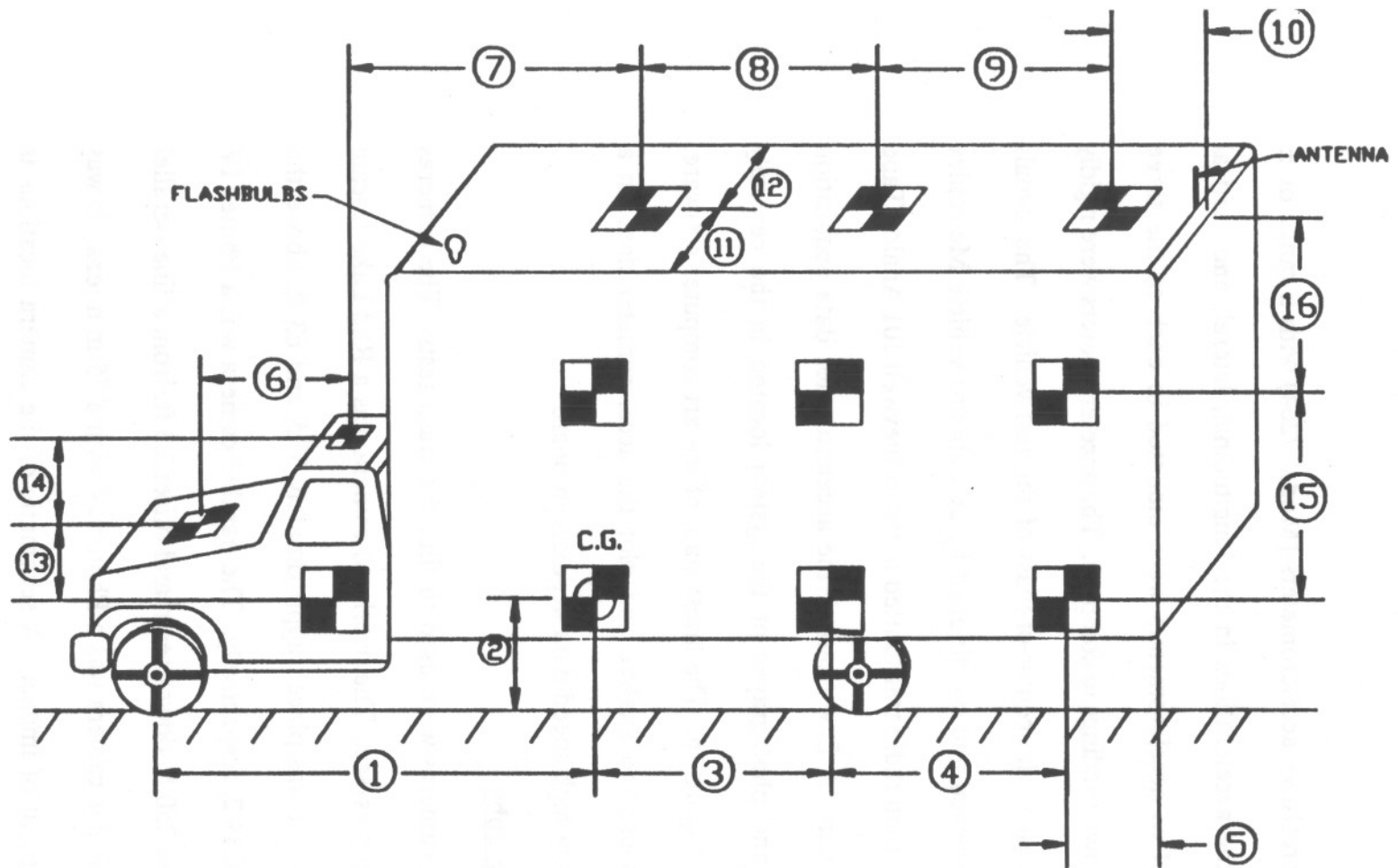

Figure 13. Photographs of center-of-mass determination using suspension method.





①	125.6	⑨	84.0
②	49.0	⑩	25.5
③	84.0	⑪	48.0
④	84.0	⑫	48.0
⑤	25.5	⑬	15.3
⑥	54.0	⑭	22.5
⑦	78.0	⑮	60.0
⑧	84.0	⑯	27.0

NOTE: NO SCALE  
All measurements  
are in inches.

Figure 14. Target locations.

## **2.4. Data Acquisition Systems**

### **2.4.1. Accelerometers**

Six endevco triaxial piezoresistive accelerometers (Model 7264) with a range of  $\pm 200$  g's were used to measure the accelerations in the longitudinal, lateral, and vertical directions of the test vehicle. Two accelerometers were mounted in each of the three directions so that there would be two readings to compare. The accelerometers were rigidly attached to a metal block mounted at the center-of-mass of the test vehicle. The signals from the accelerometers were received and conditioned by an onboard vehicle Metraplex Unit. The multiplexed signal was then radio transmitted to the Honeywell 101 Analog Tape Recorder in the central control van. A flow chart of the accelerometer data acquisition system is shown in Figure 15, and photographs of the system located in the centrally controlled step van are shown in Figure 16. The latest state of the art computer software, "Computerscope and DSP", was used to analyze and plot the accelerometer data on a cyclone 386/AT, which uses a very high-speed data acquisition board.

### **2.4.2. High-Speed Photography**

Three high-speed 16 mm cameras were used to film the crash tests. The cameras operated at approximately 500 frames/sec. The overhead camera was a Red Lake Locam with a wide angle 12.5 mm lens. It was placed approximately 57.5 and 63 ft. above the concrete apron for Tests I4-1 and I4-2, respectively. The parallel camera was a Photec IV with an 80 mm lens. It was placed 250 ft. downstream and offset 3.3 ft. from a line parallel to the barrier rail. The perpendicular camera was a Photec IV with a 55 mm lens. It was placed 165 ft. from the vehicle point of impact. A schematic of the camera locations is

shown in Figure 17.

A 20 ft. wide by 100 ft. long grid layout, shown in Figures 7 and 18, was painted on the concrete slab surface parallel and perpendicular to the barrier. The white-colored grid was incremented with 5 ft. divisions in both directions to give a visible reference system which could be used in the analysis of the overhead high-speed film.

The film was analyzed using the Vanguard Motion Analyzer. The camera divergence correction factors were also taken into consideration in the analysis of the high-speed film.

#### **2.4.3. Speed Trap Switches**

Eight tape pressure switches spaced at 5 ft. intervals, as shown in Figure 18, were used to determine the speed of the vehicle before and after impact. Each tape switch fired a blue 5B flash-bulb located near each switch on the concrete slab as the front tires of the vehicle passed over it. The average speed of the test vehicle between the tape switches was determined by knowing the distance between pressure switches, the calibrated camera speed, and the number of frames from the high-speed film between flashes. In addition, the average speed was determined from electronic timing mark data recorded on the oscilloscope software used with the 386/AT computer as the test vehicle passed over each tape switch.

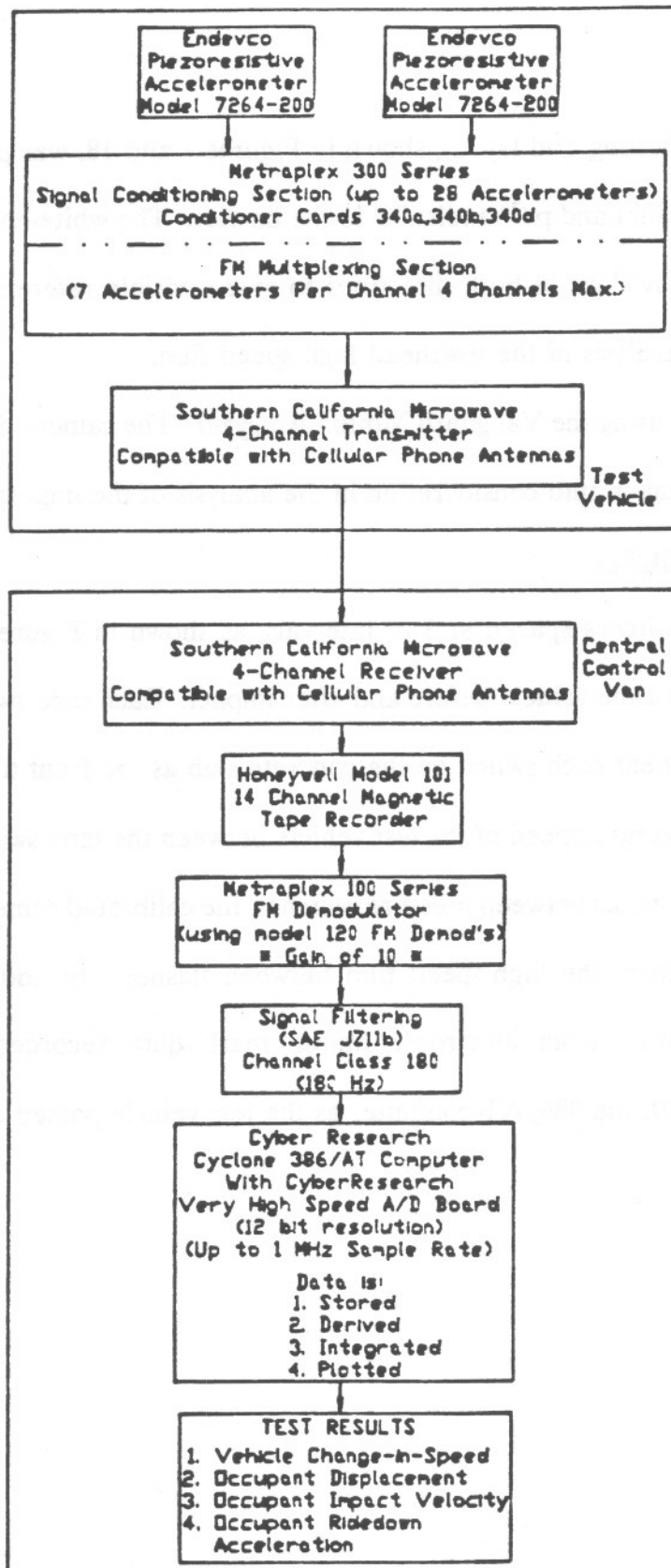

Figure 15. Flowchart of accelerometer data acquisition system.



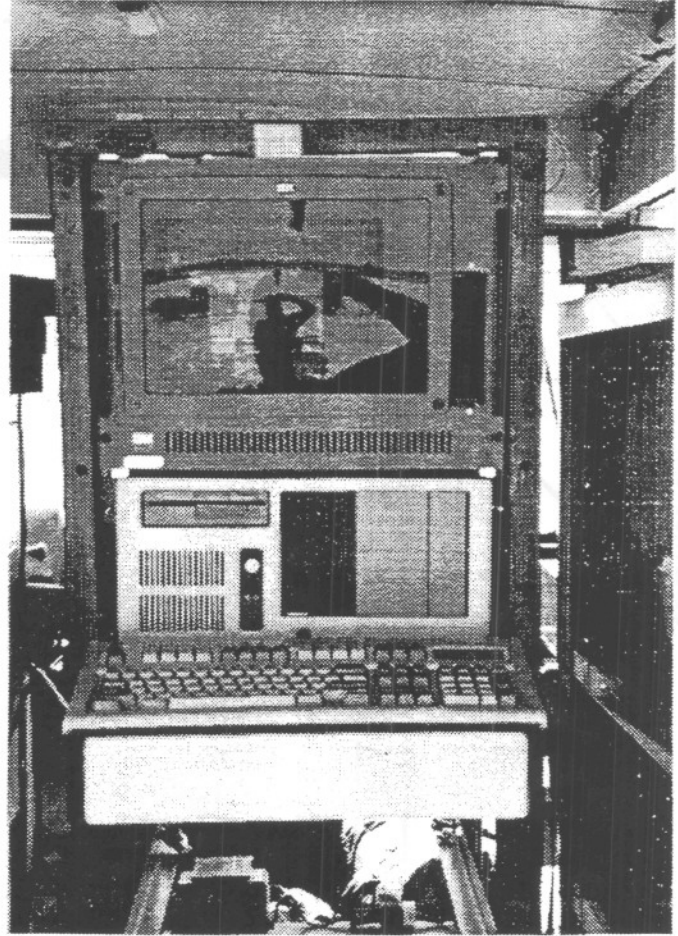
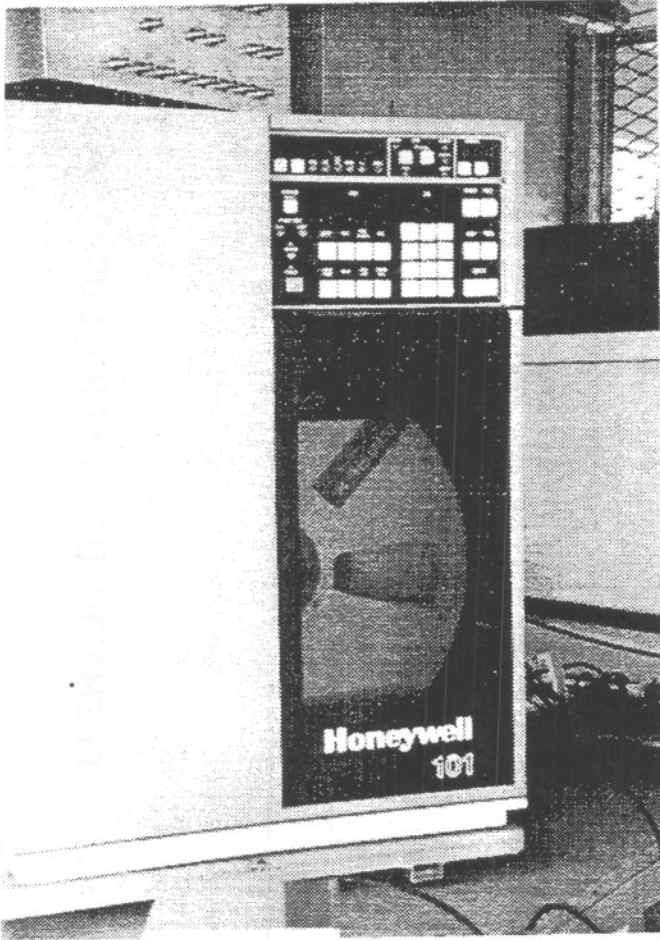

Figure 16. Photographs of data recorder and 386/AT computer.

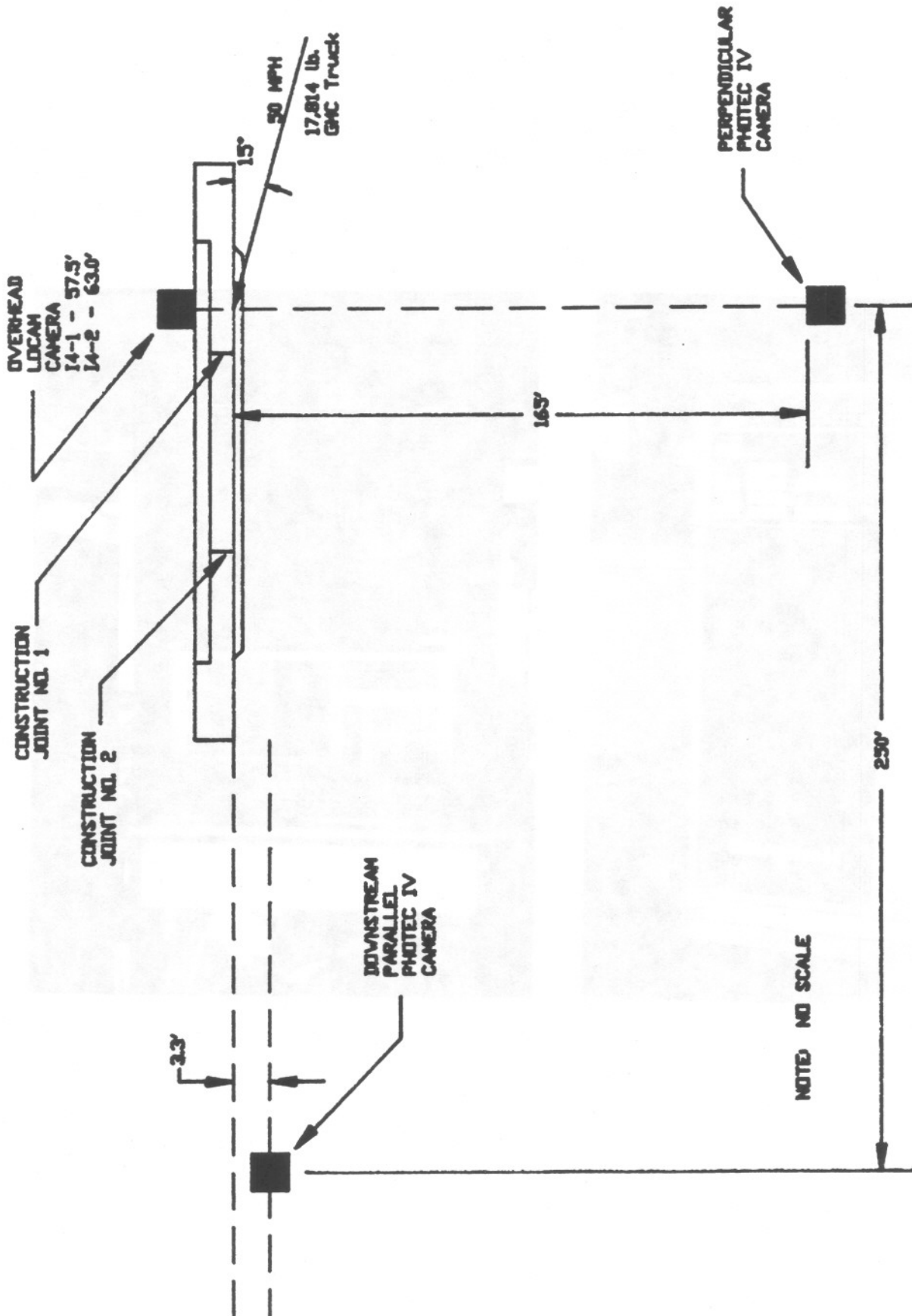

FIGURE 17. SCHEMATIC OF CAMERA LOCATIONS

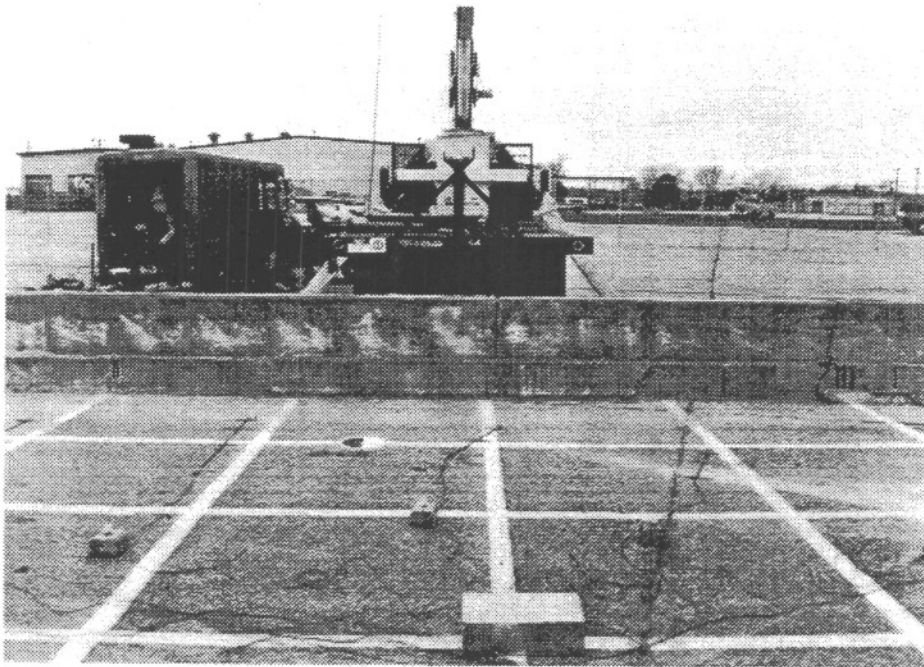

Figure 18. Photographs of speed trap switches.

## 2.5. Test Parameters

Tests I4-1 and I4-2 were conducted at a target speed of 50 mph with a target impact angle of 15 degrees. A 1983 GMC 7000 Series single-unit truck weighing 17,814 lbs. was used as the crash test vehicle. The location of impact was 22.5 ft. from the upstream end of the Iowa Retrofit Concrete Barrier Rail.

### 3. PERFORMANCE EVALUATION CRITERIA

The safety performance objective of a highway appurtenance is to minimize the consequences of a vehicle leaving the roadway to create an off-road incident. The safety goal is met when the appurtenance (Retrofit Concrete Barrier Rail) smoothly redirects the vehicle away from a hazard zone without subjecting the vehicle occupants to major injury producing forces.

Safety performance of a highway appurtenance cannot be measured directly, but it can be evaluated according to three major factors: (1) structural adequacy, (2) occupant risk, and (3) vehicle trajectory after collision. These three factors are defined and explained in NCHRP 230 (1). Similar criteria is presented in the new AASHTO (2) criteria.

Currently, there is not a specific test designation for the 18,000 lb. crash test in the NCHRP 230 Report (1). Therefore, there is not a specific set of evaluation criteria to meet from the NCHRP 230 Report (1). Thus, the evaluation criteria used to evaluate the crash tests was taken from the AASHTO Report (2). The test conditions for the matrix are shown in Table 1. Also, the specific evaluation criteria used to determine the adequacy of the barrier are listed in Table 2.

After each test, the vehicle damage was assessed by the traffic accident data scale (TAD) (7) and the vehicle damage index (VDI) (8).

**TABLE 1. CRASH TEST CONDITIONS AND EVALUATION CRITERIA**

<b>TEST AGENCY</b>	<b>SERVICE LEVEL</b>	<b>TYPE BARRIER RAILING</b>	<b>TEST VEHICLE</b>	<b>SPEED (MPH)</b>	<b>ANGLE (DEG)</b>	<b>REQUIRED CRITERIA†</b>	<b>DESIRED CRITERIA†</b>
AASHTO (1989)	PL-2	BRIDGE	18,000 LB TRUCK	50	15	A,B,C	D,E,F,H

†Description of Criteria is located in Table 2.

**TABLE 2. DESCRIPTION OF AASHTO EVALUATION CRITERIA**

A.	The test article shall contain the vehicle; neither the vehicle nor its cargo shall penetrate or go over the installation. Controlled lateral deflection of the test article is acceptable.								
B.	Detached elements, fragments, or other debris from the test article shall not penetrate or show potential for penetrating the passenger compartment or present undue hazard to other traffic.								
C.	Integrity of the passenger compartment must be maintained with no intrusion and essentially no deformation.								
D.	The vehicle shall remain upright during and after collision.								
E.	The test article shall smoothly redirect the vehicle. A redirection is deemed smooth if the rear of the vehicle does not yaw more than 5 degrees away from the railing from time of impact until the vehicle separates from the railing.								
F.	The smoothness of the vehicle- railing interaction is further assessed by the effective coefficient of friction $\mu$ , where $\mu = (\cos\theta - V_p/V)/\sin\theta$ .								
	<table border="0"> <thead> <tr> <th style="text-align: center;"><u><math>\mu</math></u></th> <th style="text-align: center;"><u>Assessment</u></th> </tr> </thead> <tbody> <tr> <td style="text-align: center;">0.00 - 0.25</td> <td style="text-align: center;">Good</td> </tr> <tr> <td style="text-align: center;">0.26 - 0.35</td> <td style="text-align: center;">Fair</td> </tr> <tr> <td style="text-align: center;">&gt; 0.35</td> <td style="text-align: center;">Marginal</td> </tr> </tbody> </table>	<u><math>\mu</math></u>	<u>Assessment</u>	0.00 - 0.25	Good	0.26 - 0.35	Fair	> 0.35	Marginal
<u><math>\mu</math></u>	<u>Assessment</u>								
0.00 - 0.25	Good								
0.26 - 0.35	Fair								
> 0.35	Marginal								
H.	Vehicle exit angle from the barrier shall not be more than 12 degrees. Within 100 ft. plus the length of the test vehicle from the point of initial impact with the railing, the railing side of the vehicle shall move no more than 20 ft. from the line of the traffic face of railing.								



## 4. TEST RESULTS

### 4.1. Test No. I4-1

Test No. I4-1 was conducted with a 1983 7000 Series GMC single unit truck weighing 17,814 lb. The impact occurred 22.5 ft. from the upstream end of the barrier at a speed of 44.8 mph and at an angle of 15.6 degrees. A summary of the test results and sequential photos is shown in Figure 19. Additional sequential photos are shown in Figure 20.

Upon impact with the retrofit concrete barrier rail, the right front corner of the vehicle was crushed and the wheel was bent inward. After the initial impact, the vehicle rode up on the barrier and slid along the remaining length. There was significant clockwise rolling motion as the vehicle slid along the barrier with a maximum roll angle of 31.4 degrees. After the vehicle exited from the barrier, it rolled in the counterclockwise direction for a short period of time. Hence, the momentum of the vehicle caused it to roll in the clockwise direction and tip over onto the passenger side of the vehicle. The vehicle came to rest on the passenger side of the vehicle approximately 160 ft. downstream from the point of impact.

Photographs of the vehicle damage are shown in Figure 21. The TAD (7) and VDI (8) damage classifications are shown in Figure 19. Photographs of the minimal damage to the retrofit concrete barrier rail are shown in Figure 22. Some concrete spalling occurred due to the initial impact of the vehicle.

The radio transmitted signal from the accelerometers was not adequately received by the central control van. This was thought to occur due to the location of the antenna at the rear of the long metal truck box. Thus, it was necessary to analyze the high-speed film



to determine the change in velocity and deceleration curves for the test. Graphs of the longitudinal and lateral deceleration, vehicle change in speed, lateral occupant impact velocity, and longitudinal and lateral occupant displacement versus time are given in Appendix C.

The longitudinal occupant displacement did not reach 24 inches while the vehicle was within the field of view of the overhead camera so there was no longitudinal occupant impact velocity or ridedown decelerations available.

Due primarily to a strong headwind, the vehicle did not reach the required impact speed in Test I4-1. The test was repeated as I4-2 with two tow vehicles rigidly connected to each other, as shown in Figure 3. Several practice runs were made prior to the test to ensure that this system would be adequate. It was found that the horsepower from the two vehicles was sufficient to overcome a small head wind.

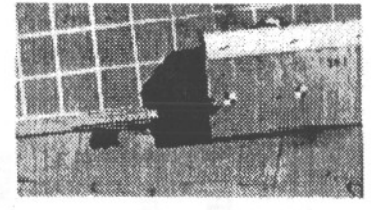
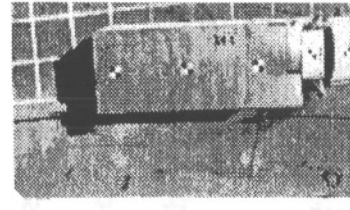
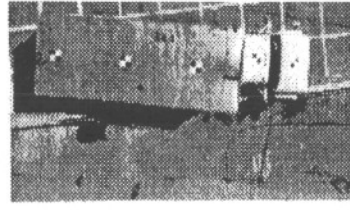
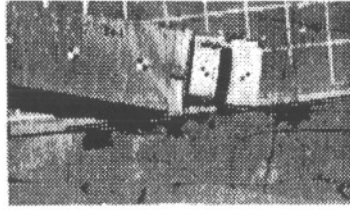
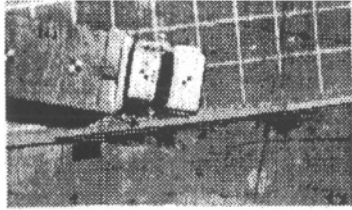

Impact

87.2 msec

184.3 msec

305.2 msec

453.9 msec

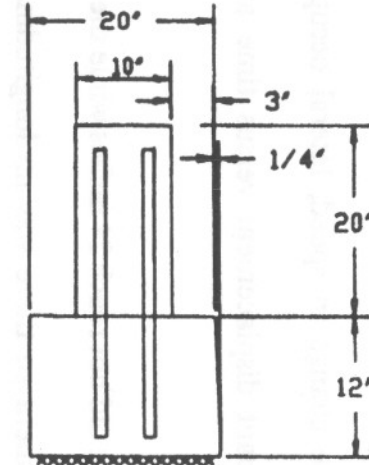
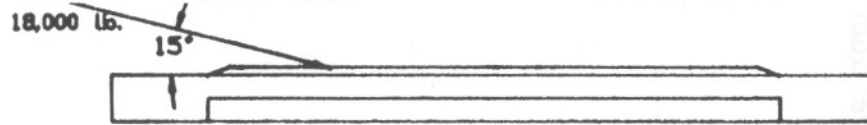

35

Test No. . . . . I4-1  
 Date. . . . . 8/23/89  
 Installation . . . . . Retrofit Concrete  
                   Barrier Rail  
 Drawing No. . . . . BRF-0005(2)-38-00  
 Length (ft) . . . . . 100  
**Concrete Barrier**  
 Material . . . . . Nebraska Class  
                   '47-B-PHE' Mix  
 Member . . . . . Rectangular Concrete  
                   Wall-Section  
 Length . . . . . 86  
**Dimensions**  
     Width (in) . . . . . 10  
     Height (in) . . . . . 20  
 Member . . . . . Existing Concrete  
                   Curb-Section  
 Length (ft) . . . . . 86  
**Dimensions**  
     Width (in) . . . . . 20  
     Height (in) . . . . . 12  
 Member . . . . . Concrete Endwalls  
     Length (ft) . . . . . 7 (each end)  
**Dimensions**  
     Width (in) . . . . . 20  
     Height (in) . . . . . 32

**Vehicle**  
 Model. . . . . 1983 7000 Series GMC  
 Weight. . . . .  
     Test Inertia (lb) . . . . . 17,814  
     Gross Static (lb) . . . . . 17,814  
**Vehicle Speed**  
     Impact (mph) . . . . . 44.8  
     Exit (mph) . . . . . 40.7  
**Vehicle Angle**  
     Impact (deg) . . . . . 15.6  
     Exit (deg) . . . . . 6.0  
**Vehicle Snagging** . . . . . none  
**Vehicle Stability** . . . . . satisfactory  
**Occupant Impact Velocity**  
     Longitudinal (fps) . . . . . NA  
     Lateral (fps) . . . . . 4.75  
**Occupant Ridedown Decelerations**  
     Longitudinal (g's) . . . . . NA  
     Lateral (g's) . . . . . +2.5  
**Vehicle Damage**  
     TAD . . . . . 1-RFQ-3  
     VDI . . . . . 01RFES2  
**Vehicle Rebound Dist (ft)** . . . . . 22.2 AT 130  
**Bridge Rail Damage** . . . . . Minor concrete spalling

Figure 19. Test I4-1 summary and sequential photos.



-69.4 msec



705.6 msec



Impact

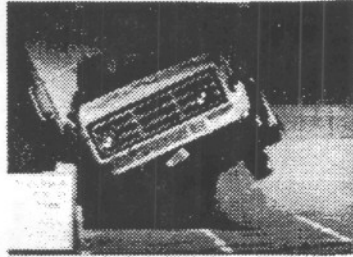

1052.4 msec



87.2 msec

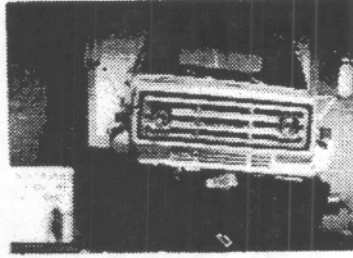

1627.1 msec



184.3 msec

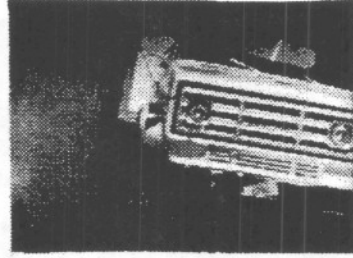

2116.7 msec



305.2 msec

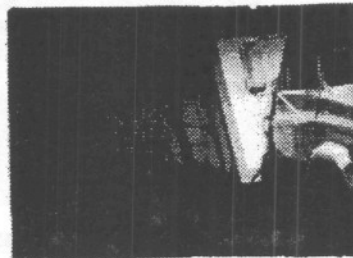

2594.3 msec

Figure 20. Parallel time-sequential photos, Test I4-1.

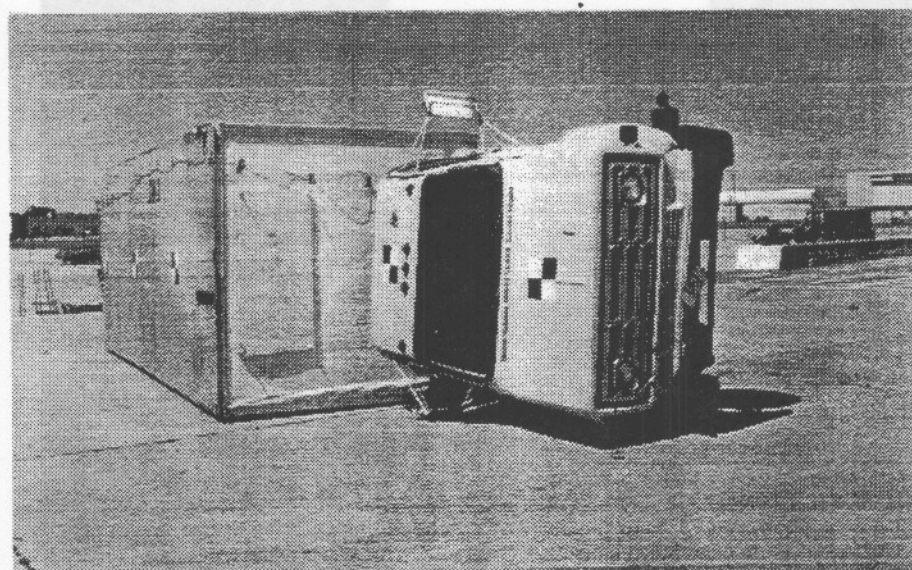
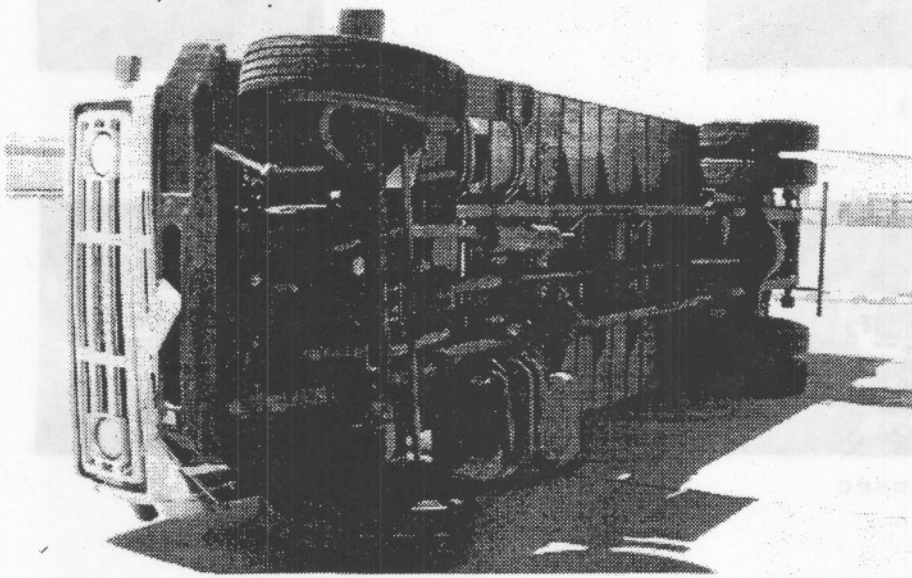
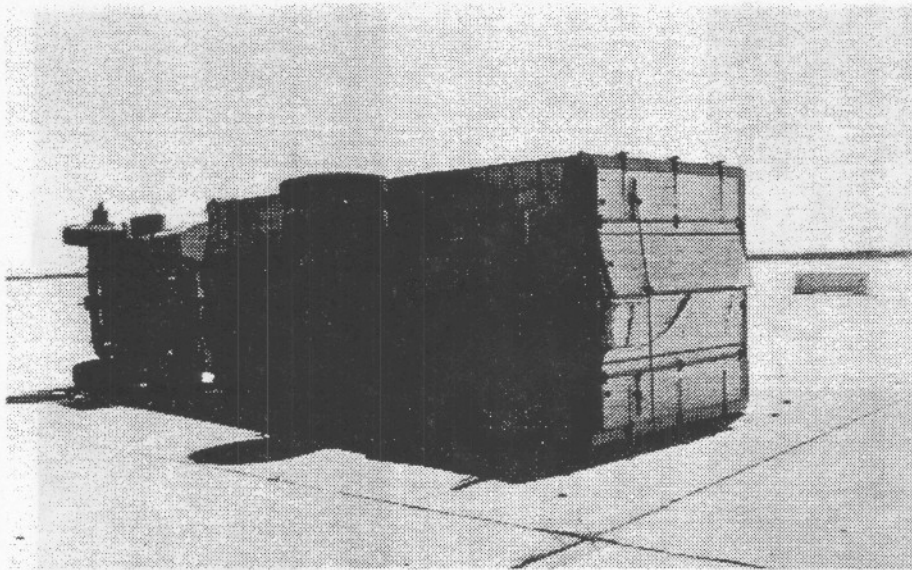

Figure 21. Photographs of vehicle damage, Test I4-1.



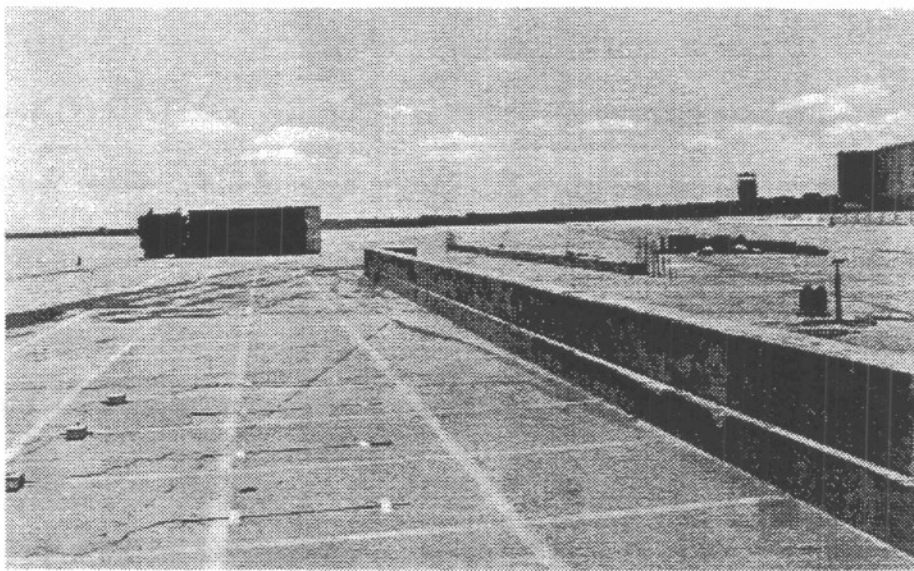
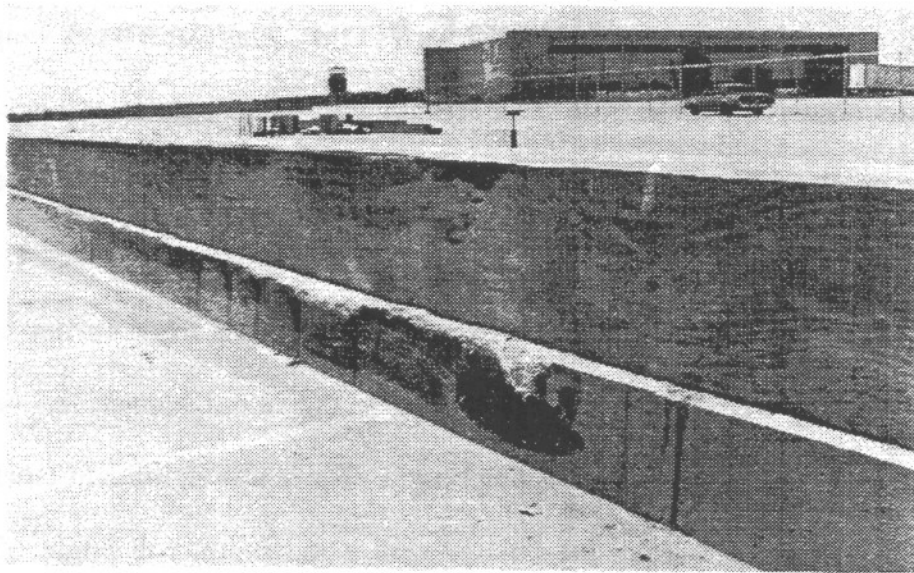

Figure 22. Retrofit Concrete Barrier Rail Damage, Test I4-1.

#### 4.2. Test No. I4-2

Test No. I4-2 was conducted with a 1983 7000 Series GMC single unit truck weighing 17,814 lb. The impact occurred 22.5 ft. from the upstream end of the barrier at a speed of 49.9 mph. and at an angle of 15.1 degrees. A summary of the test results and sequential photos is shown in Figure 23. Additional sequential photos are shown in Figure 24.

Upon impact with the retrofit concrete barrier rail, the right front corner of the vehicle was crushed and the wheel was bent inward. After the initial impact, the vehicle rode up on the barrier and slid along the remaining length. There was significant clockwise rolling motion as the vehicle slid along the barrier with a maximum roll angle of 28.7 degrees. After the vehicle exited from the barrier, it rolled in the counterclockwise direction for a short period of time. Hence, the momentum of the vehicle caused it to roll in the clockwise direction and tip over onto the passenger side of the vehicle. The vehicle came to rest on the passenger side of the vehicle approximately 160 ft. downstream from the point of impact.

Photographs of the vehicle damage are shown in Figure 25. The TAD (7) and VDI (8) damage classifications are shown in Figure 23. Photographs of the minimal damage to the retrofit concrete barrier rail are shown in Figure 26. Some concrete spalling occurred due to the initial impact of the vehicle.

The radio transmitted signal from the accelerometers was not adequately received by the central control van. This was thought to occur due to the location of the antenna at the rear of the long metal truck box. Thus, it was necessary to analyze the high-speed film to determine the change in velocity and deceleration curves for the test. Graphs of the

longitudinal and lateral deceleration, vehicle change in speed, lateral occupant impact velocity, and longitudinal and lateral occupant displacement versus time are given in Appendix C.

The longitudinal occupant displacement did not reach 24 inches while the test vehicle was within the field of view of the overhead camera so there was no longitudinal occupant impact velocity or ridedown decelerations available.

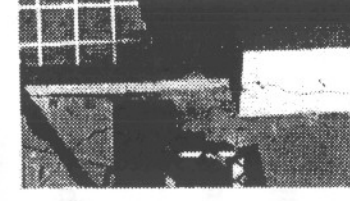
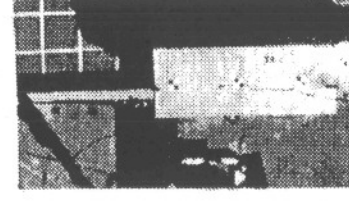
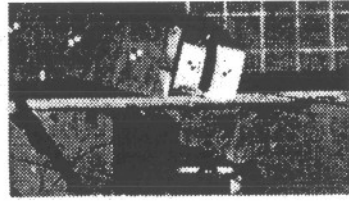
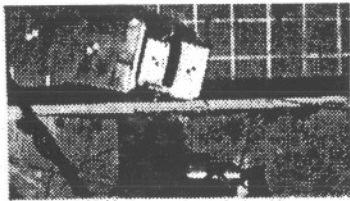

Impact

74.2 msec

176.4 msec

336.8 msec

485.3 msec

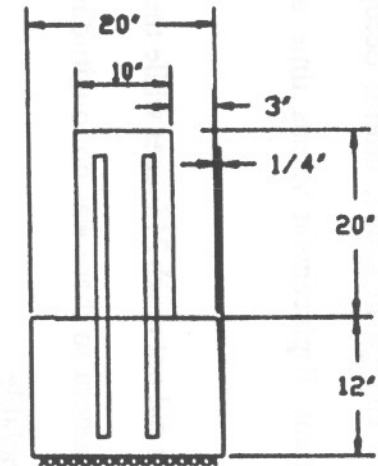
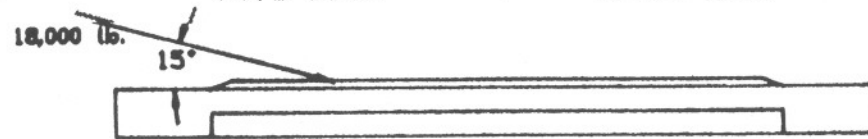

41

Test No. . . . . I4-2  
 Date. . . . . 10/12/89  
 Installation . . . . . Retrofit Concrete  
                     Barrier Rail  
 Drawing No. . . . . BRF-0005(2)-38-00  
 Length (ft) . . . . . 100  
**Concrete Barrier**  
 Material . . . . . Nebraska Class  
                     '47-B-PHE' Mix  
 Member . . . . . Rectangular Concrete  
                     Wall-Section  
 Length . . . . . 86  
**Dimensions**  
     Width (in) . . . . . 10  
     Height (in) . . . . . 20  
 Member . . . . . Existing Concrete  
                     Curb-Section  
 Length (ft) . . . . . 86  
**Dimensions**  
     Width (in) . . . . . 20  
     Height (in) . . . . . 12  
 Member . . . . . Concrete Endwalls  
     Length (ft) . . . . . 7 (each end)  
**Dimensions**  
     Width (in) . . . . . 20  
     Height (in) . . . . . 32

**Vehicle**  
 Model . . . . . 1983 7000 Series GMC  
 Weight . . . . .  
     Test Inertia (lb) . . . . . 17,814  
     Gross Static (lb) . . . . . 17,814  
**Vehicle Speed**  
 Impact (mph) . . . . . 49.9  
 Exit (mph) . . . . . 44.1  
**Vehicle Angle**  
 Impact (deg) . . . . . 15.1  
 Exit (deg) . . . . . 4.1  
**Vehicle Snagging** . . . . . none  
**Vehicle Stability** . . . . . satisfactory  
**Occupant Impact Velocity**  
     Longitudinal (fps) . . . . . NA  
     Lateral (fps) . . . . . 8.8  
**Occupant Ridedown Decelerations**  
     Longitudinal (g's) . . . . . NA  
     Lateral (g's) . . . . . +4.0  
**Vehicle Damage**  
     TAD . . . . . I-RFQ-3  
     VDI . . . . . 01RFES2  
 Vehicle Rebound Dist (ft) . . . . . 9.3 at 130  
 Bridge Rail Damage . . . . . Minor concrete spalling

Figure 23. Test I4-2 summary and sequential photos.



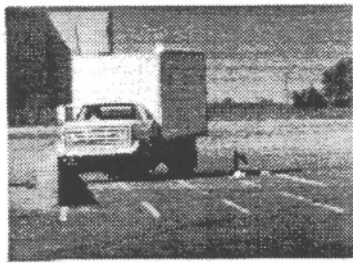

Impact



74.2 msec



176.4 msec



336.8 msec



705.7 msec



1349.3 msec



2221.5 msec



2652.5 msec



2983.3 msec

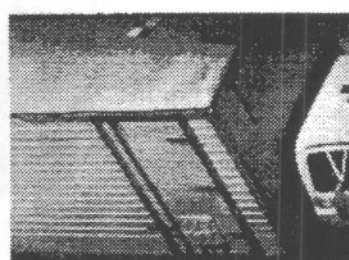

3424.4 msec

Figure 24. Parallel time-sequential photos, Test I4-2.

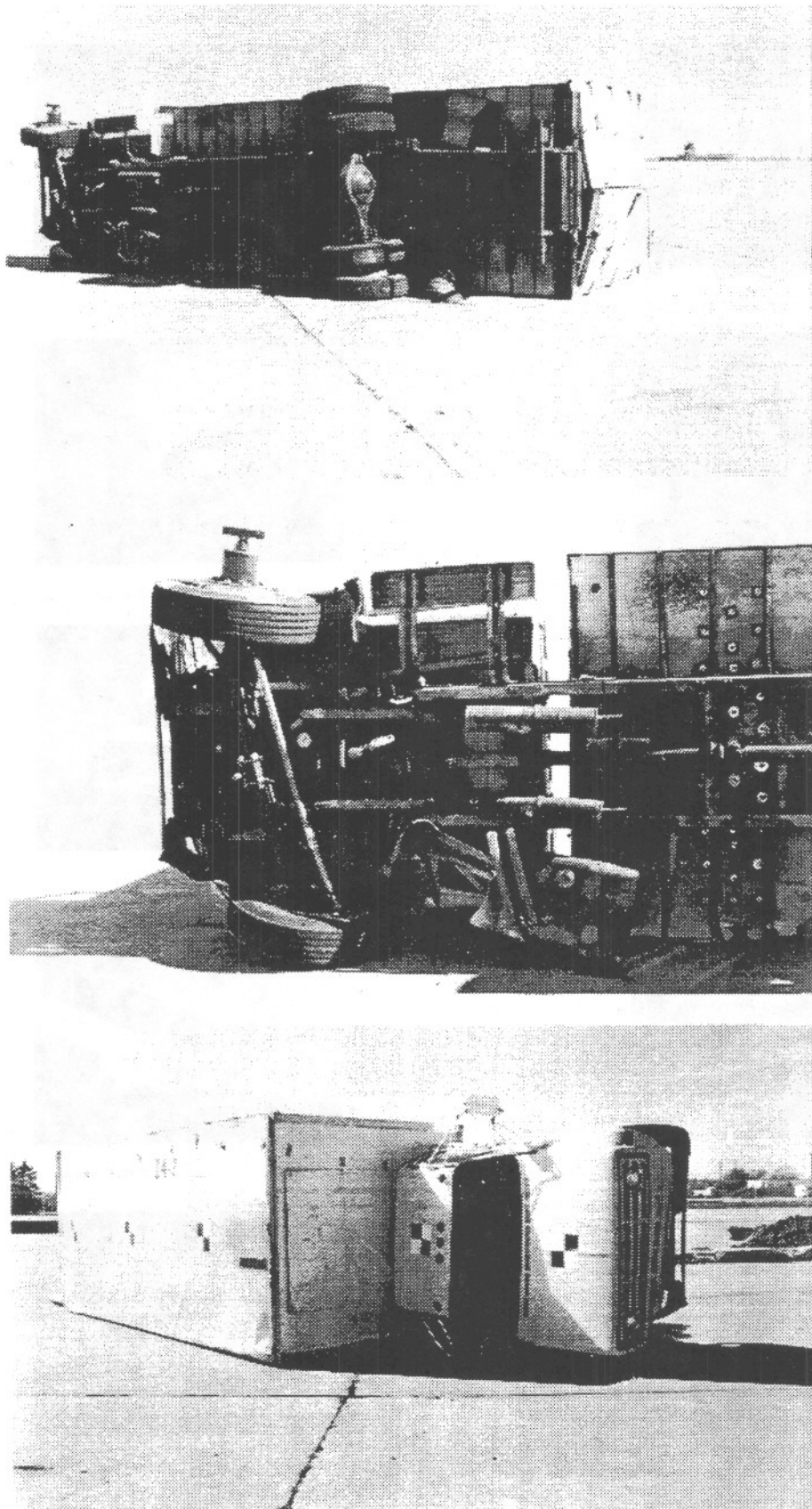

Figure 25. Photographs of vehicle damage, Test I4-2.

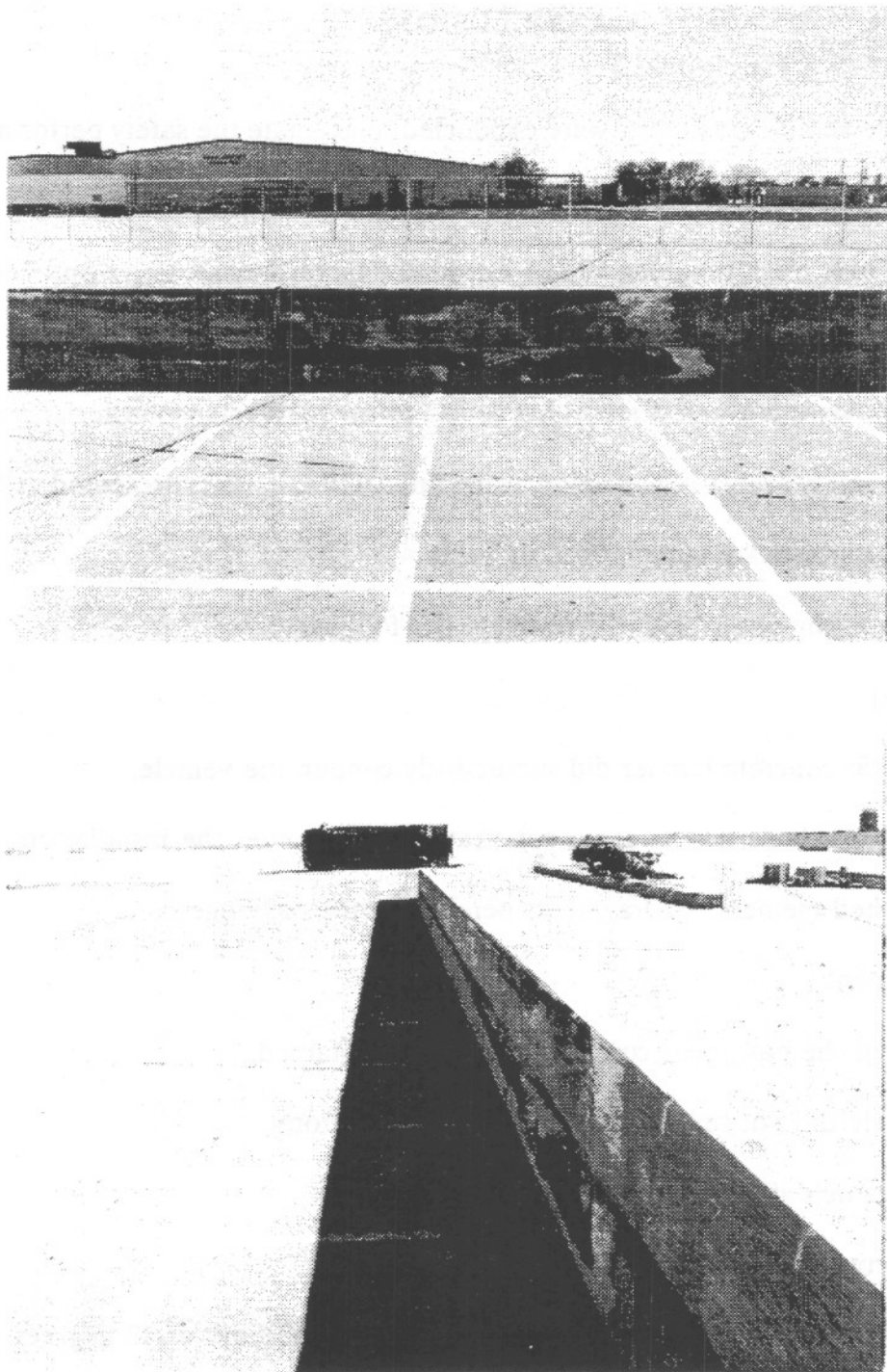

Figure 26. Retrofit Concrete Barrier damage, Test I4-2.

## 5. CONCLUSIONS

Two full-scale vehicle crash tests were conducted to evaluate the safety performance of the Iowa Retrofit Concrete Barrier Rail. Both tests were conducted with a 1983 7000 Series GMC single unit truck weighing 17,814 lbs. with a target impact angle and velocity of 15 degrees and 50 mph, respectively.

The two tests were evaluated according to the safety performance criteria given in AASHTO (2). The safety evaluation summary using this set of criteria is presented in Table 3. The results of both tests are summarized in Table 4.

The analysis of the two crash tests revealed the following:

### Test No. I4-1

1. The retrofit concrete barrier did successively contain the vehicle.
2. Neither the vehicle nor its cargo penetrated or went over the installation.
3. No detached elements or fragments penetrated the passenger compartment.
4. Integrity of the passenger compartment was maintained.
5. The vehicle did not remain upright after the collision.
6. The test article did smoothly redirect the vehicle.
7. The effective coefficient of friction was good.
8. The vehicle's exit angle of 6 degrees was less than the limit of 12 degrees.

Test No. I4-2

1. The retrofit concrete barrier did successively contain the vehicle.
2. Neither the vehicle nor its cargo penetrated or went over the installation.
3. No detached elements or fragments penetrated the passenger compartment.
4. Integrity of the passenger compartment was maintained.
5. The vehicle did not remain upright after the collision.
6. The test article did smoothly redirect the vehicle.
7. The effective coefficient of friction was good.
8. The vehicle's exit angle of 4.1 degrees was less than the limit of 12 degrees.

Based upon the items listed above, the results of Tests I4-1 and I4-2 proved to be both consistent and acceptable to the AASHTO (2) guidelines.

TABLE 3. AASHTO EVALUATION CRITERIA

EVALUATION CRITERIA	TEST I4-1	TEST I4-2								
<b>REQUIRED</b>										
A. The test article shall contain the vehicle; neither the vehicle nor its cargo shall penetrate or go over the installation. Controlled lateral deflection of the test article is acceptable.	S	S								
B. Detached elements, fragments, or other debris from the test article shall not penetrate or show potential for penetrating the passenger compartment or present undue hazard to other traffic.	S	S								
C. Integrity of the passenger compartment must be maintained with no intrusion and essentially no deformation.	S	S								
<b>DESIRABLE</b>										
D. The vehicle shall remain upright during and after collision.	U	U								
E. The test article shall smoothly redirect the vehicle. A redirection is deemed smooth if the rear of the vehicle does not yaw more than 5 degrees away from the railing from time of impact until the vehicle separates from the railing.	S	S								
F. The smoothness of the vehicle-railing interaction is further assessed by the effective coefficient of friction $\mu$ ; where $\mu = (\cos\theta - V_p/V)/\sin\theta$ .	0.10	0.10								
<table border="0" style="width: 100%;"> <tr> <td style="text-align: center;"><u><math>\mu</math></u></td> <td style="text-align: center;"><u>Assessment</u></td> </tr> <tr> <td style="text-align: center;">0.00 - 0.25</td> <td style="text-align: center;">Good</td> </tr> <tr> <td style="text-align: center;">0.26 - 0.35</td> <td style="text-align: center;">Fair</td> </tr> <tr> <td style="text-align: center;">&gt; 0.35</td> <td style="text-align: center;">Marginal</td> </tr> </table>	<u><math>\mu</math></u>	<u>Assessment</u>	0.00 - 0.25	Good	0.26 - 0.35	Fair	> 0.35	Marginal		
<u><math>\mu</math></u>	<u>Assessment</u>									
0.00 - 0.25	Good									
0.26 - 0.35	Fair									
> 0.35	Marginal									
H. Vehicle exit angle from the barrier shall not be more than 12 degrees. Within 100 ft. plus the length of the test vehicle from the point of initial impact with the railing, the railing side of the vehicle shall move no more than 20 ft. from the line of the traffic face of the railing.	S	S								

S - Satisfactory      M - Marginal      U - Unsatisfactory      G - Good



TABLE 4. SUMMARY OF TEST RESULTS

TEST ITEM	TEST NO. I4-1	TEST NO. I4-2
Vehicle Weight (lb.)	17,814	17,814
Vehicle Impact Speed (mph)	44.8	49.9
Vehicle Exit Speed (mph)	40.7	44.0
Vehicle Impact Angle (deg.)	15.6	15.1
Vehicle Exit Angle (deg.)	6.0	4.1
Vehicle Rebound Distance (ft.)	22.2	11.8
Vehicle Damage (TAD) (7)	1-RFQ-3	1-RFQ-3
Vehicle Damage (VDI) (8)	01RFES2	01RFES2
Longitudinal Occupant Impact Velocity (fps)	N.A.	N.A.
Lateral Occupant Impact Velocity (fps)	4.75	8.8
Longitudinal Occupant Ridedown Deceleration (g's)	N.A.	N.A.
Lateral Occupant Ridedown Deceleration (g's)	2.5	4.0
Did snagging occur?	No	No
Did vehicle remain upright?	No	No

## 6. RECOMMENDATIONS

The Iowa Retrofit Concrete Barrier Rail has met the criteria for all three of the vehicle classifications of the PL-2 performance level in the AASHTO guide specifications (2).

Therefore, it is recommended that the Federal Highway Administration approve this appurtenance as a safe design and qualify it for use on Federal Aid Projects.

## 7. REFERENCES

1. "Recommended Procedures for the Safety Performance Evaluation of Highway Appurtenances", National Cooperative Highway Research Program Report 230, Transportation Research Board, Washington, D.C. March, 1981.
2. "Guide Specifications for Bridge Railings," American Association of State Highways and Transportation Officials, Washington, D.C., 1989.
3. Faller, R.K., Magdaleno, J.A., Post, E.R., "Full-Scale Vehicle Crash Tests on the Iowa Retrofit Concrete Barrier Rail", Final Report to Iowa Department of Transportation, Report No. TRP-03-015-89, Civil Engineering Department, University of Nebraska-Lincoln, January, 1989.
4. Hinch, J., Yang, T.L., and Owings, R., "Guidance Systems for Vehicle Testing", ENSCO, Inc., Springfield, VA, 1986.
5. Faller, R.K., Magdaleno, J.A., Post, E.R., "Full-Scale Vehicle Crash Tests on the Iowa Box-Aluminum Bridge Rail", Final Report to Iowa Department of Transportation, Report No. TRP-03-013-88, Civil Engineering Department, University of Nebraska-Lincoln, November, 1988.
6. "Center of Gravity Test Code - SAE J874 March 1981", SAE Handbook Vol. 4, Society of Automotive Engineers, Inc., Warrendale, Penn., 1986.
7. "Vehicle Damage Scale for Traffic Accident Investigators", Traffic Accident Data Project Technical Bulletin No. 1, National Safety Council, Chicago, Ill., 1971.
8. "Collision Deformation Classification, Recommended Practice J224 March 1980", SAE Handbook Vol. 4, Society of Automotive Engineers, Warrendale, Penn., 1985.

## 8. APPENDICES

1. The first appendix is the report of the ...  
2. The second appendix is the report of the ...  
3. The third appendix is the report of the ...

4. The fourth appendix is the report of the ...  
5. The fifth appendix is the report of the ...

6. The sixth appendix is the report of the ...  
7. The seventh appendix is the report of the ...  
8. The eighth appendix is the report of the ...

9. The ninth appendix is the report of the ...  
10. The tenth appendix is the report of the ...

11. The eleventh appendix is the report of the ...  
12. The twelfth appendix is the report of the ...  
13. The thirteenth appendix is the report of the ...

14. The fourteenth appendix is the report of the ...  
15. The fifteenth appendix is the report of the ...

16. The sixteenth appendix is the report of the ...  
17. The seventeenth appendix is the report of the ...

18. The eighteenth appendix is the report of the ...  
19. The nineteenth appendix is the report of the ...





# STATE OF NEBRASKA

## DEPARTMENT OF ROADS

**KAY A. ORR**  
GOVERNOR

**G. C. STROBEL**  
DIRECTOR-STATE ENGINEER

Dr. Edward R. Post  
University of Nebraska  
Department of Civil Engineering  
W348 Nebraska Hall  
Lincoln, NE 68588-0531

November 3, 1988

Reference: Project No. BRF-0005(2)--38--00

Dear Dr. Post:

Final inspection on phase 2 of the above referenced project has been made. It is our opinion that the work is in reasonable conformity to the plans and specifications and is acceptable.

Compressive strengths of concrete cylinders fabricated during this phase are as follows:

ITEM	DATE PLACED	AGE (days)	COMPRESSIVE STRENGTH
Curb Repair	10/11/88	7	5090 psi
		14	5620 psi
Barrier rail (35' sec's.) and both end sections	10/14/88	7	5450 psi
		10	4880 psi
		14	5090 psi
Barrier rail-center section	10/17/88	7	4530 psi
		14	5940 psi

Results of the 28 day breaks will be forwarded when completed. Cylinders were cured under field conditions so compressive strengths should be representative of the material in the structure.

Best Regards,

Dalyce Ronnau  
Assistant Engineer  
Materials & Tests Division

DR/bb





# STATE OF NEBRASKA

## DEPARTMENT OF ROADS

KAY A. ORR  
GOVERNOR

G. C. STROBEL  
DIRECTOR-STATE ENGINEER

Dr. Edward R. Post  
University of Nebraska  
Department of Civil Engineering  
W348 Nebraska Hall  
Lincoln, NE 68588-0531

November 22, 1988

Reference: Project No. BRF-0005(2)--38--00

Dear Dr. Post:

Compressive strengths of concrete cylinders fabricated during Phase 2 of the above referenced project are as follows:

ITEM	DATE PLACED	AGE (days)	Compressive Strength
Curb Repair	10/11/88	7	5090 psi
		14	5620 psi
		28	5620 psi
Barrier rail (35' sec's.) and both end sections	10/14/88	7	5450 psi
		10	4880 psi
		14	5090 psi
		28	6050 psi
Barrier rail-center section	10/17/88	7	4530 psi
		14	5940 psi
		35	6440 psi

Please advise should further information on the concrete placements be needed.

Best Regards,

Dalcyce Ronnau  
Assistant Engineer  
Materials & Tests Division

DR/bb

APPENDIX B.

G. STANLEY  
DIRECTOR STATE ENGINEER

1911  
1912

IDOT CORRESPONDENCE

November 22, 1911

1911	1912
1913	1914
1915	1916
1917	1918
1919	1920
1921	1922
1923	1924
1925	1926
1927	1928
1929	1930
1931	1932
1933	1934
1935	1936
1937	1938
1939	1940
1941	1942
1943	1944
1945	1946
1947	1948
1949	1950
1951	1952
1953	1954
1955	1956
1957	1958
1959	1960
1961	1962
1963	1964
1965	1966
1967	1968
1969	1970
1971	1972
1973	1974
1975	1976
1977	1978
1979	1980
1981	1982
1983	1984
1985	1986
1987	1988
1989	1990
1991	1992
1993	1994
1995	1996
1997	1998
1999	2000
2001	2002
2003	2004
2005	2006
2007	2008
2009	2010
2011	2012
2013	2014
2015	2016
2017	2018
2019	2020
2021	2022
2023	2024
2025	2026
2027	2028
2029	2030
2031	2032
2033	2034
2035	2036
2037	2038
2039	2040
2041	2042
2043	2044
2045	2046
2047	2048
2049	2050
2051	2052
2053	2054
2055	2056
2057	2058
2059	2060
2061	2062
2063	2064
2065	2066
2067	2068
2069	2070
2071	2072
2073	2074
2075	2076
2077	2078
2079	2080
2081	2082
2083	2084
2085	2086
2087	2088
2089	2090
2091	2092
2093	2094
2095	2096
2097	2098
2099	2100



# Iowa Department of Transportation

800 Lincoln Way, Ames, Iowa 50010 515/239-1206

August 31, 1988

Ref. No. Statewide Safety  
BRF-000S(2)--38-00

Dr. Edward R. Post  
Civil Engineering Department  
University of Nebraska  
W348 Nebraska Hall  
Lincoln, Nebraska 68588-0531

Dear Dr. Post:

In order to more accurately represent existing installations as they are actually constructed, we will require certain changes or restrictions to the details for the Retrofit Concrete Barrier Rail to be tested. Project Sheet 3 of 4, showing the installation for task No. 2 of our testing contract, shall be changed as follows:

1. For dowel setting, the epoxy grout system shall be used.
2. Provide two construction joints within the length of rail. Vehicle impact should be just behind a construction joint. As shown by the project sheet, longitudinal reinforcing shall extend through the construction joint.
3. Vertical bars are to be spaced transversely as shown by the project sheet. The dimensions as shown are clear dimensions.
4. The front vertical face of the retrofit barrier shall be a constant 3 inches from the top front edge of the curb i.e. keep dimension "x" at 3 inches.

Please notify the Nebraska Department of Roads and your subcontractor, M. E. Collins Contracting Co., of these revisions. Three copies of the revised project sheet are enclosed for your use.

Sincerely,

A handwritten signature in cursive script that reads "William A. Lundquist".

William A. Lundquist  
Bridge Engineer

WAL:WCE/dlt  
enclosure

cc: R. Humphrey, G. Anderson  
B. Brown, B. Brakke, FHWA



# Iowa Department of Transportation

800 Lincoln Way, Ames, Iowa 50010 515/239-1206

September 9, 1988

Ref. No. 521.5

Dr. Edward R. Post  
Civil Engineering Department  
University of Nebraska  
W348 Nebraska Hall  
Lincoln, Nebraska 68588-0531

Dear Dr. Post:

This memo is to advise you that, based on the tests run previously, no further testing of the box-aluminum rail system (Task I) is required. You may proceed to remove that rail system and construct the concrete retrofit wall in preparation for the testing required for Task II.

The Iowa Department of Transportation and FHWA have agreed that the vehicles used in Task II be as follows:

<u>Vehicle (lb)</u>	<u>Speed (mph)</u>	<u>Impact Angle (degrees)</u>
1800	60	20
5400 (pickup)	60	20

Also, construction details shall be as listed in my memo of August 31, 1988.

Inspection of the damage to the rail and curb section due to Task I testing indicated that all of the reinforcing bars for the curb were not placed in accordance with the plan. Although this apparent misplacement probably did not affect that testing it is imperative that the rebars be placed correctly for Task II testing. I would request that this requirement be brought to the attention of the Contractor and Inspector.

Sincerely,

*William A. Lundquist*  
William A. Lundquist  
Bridge Engineer

WAL:dlt  
cc: R. Humphrey, G. Anderson  
B. Brown, G. Sisson  
B. Brakke, FHWA

## APPENDIX C.

### HIGH-SPEED FILM ANALYSIS

	Page
C-1. Graph of Longitudinal Deceleration, Test I4-1 .....	59
C-2. Graph of Vehicle Change in Speed, Test I4-1 .....	60
C-3. Graph of Longitudinal Occupant Displacement, Test I4-1 .....	61
C-4. Graph of Lateral Deceleration, Test I4-1 .....	62
C-5. Graph of Lateral Occupant Impact Velocity, Test I4-1 .....	63
C-6. Graph of Lateral Occupant Displacement, Test I4-1 .....	64
C-7. Graph of Longitudinal Deceleration, Test I4-2 .....	65
C-8. Graph of Vehicle Change in Speed, Test I4-2 .....	66
C-9. Graph of Longitudinal Occupant Displacement, Test I4-2 .....	67
C-10. Graph of Lateral Deceleration, Test I4-2 .....	68
C-11. Graph of Lateral Occupant Impact Velocity, Test I4-2 .....	69
C-12. Graph of Lateral Occupant Displacement, Test I4-2 .....	70

LONGITUDINAL DECELERATION - TEST I4-1

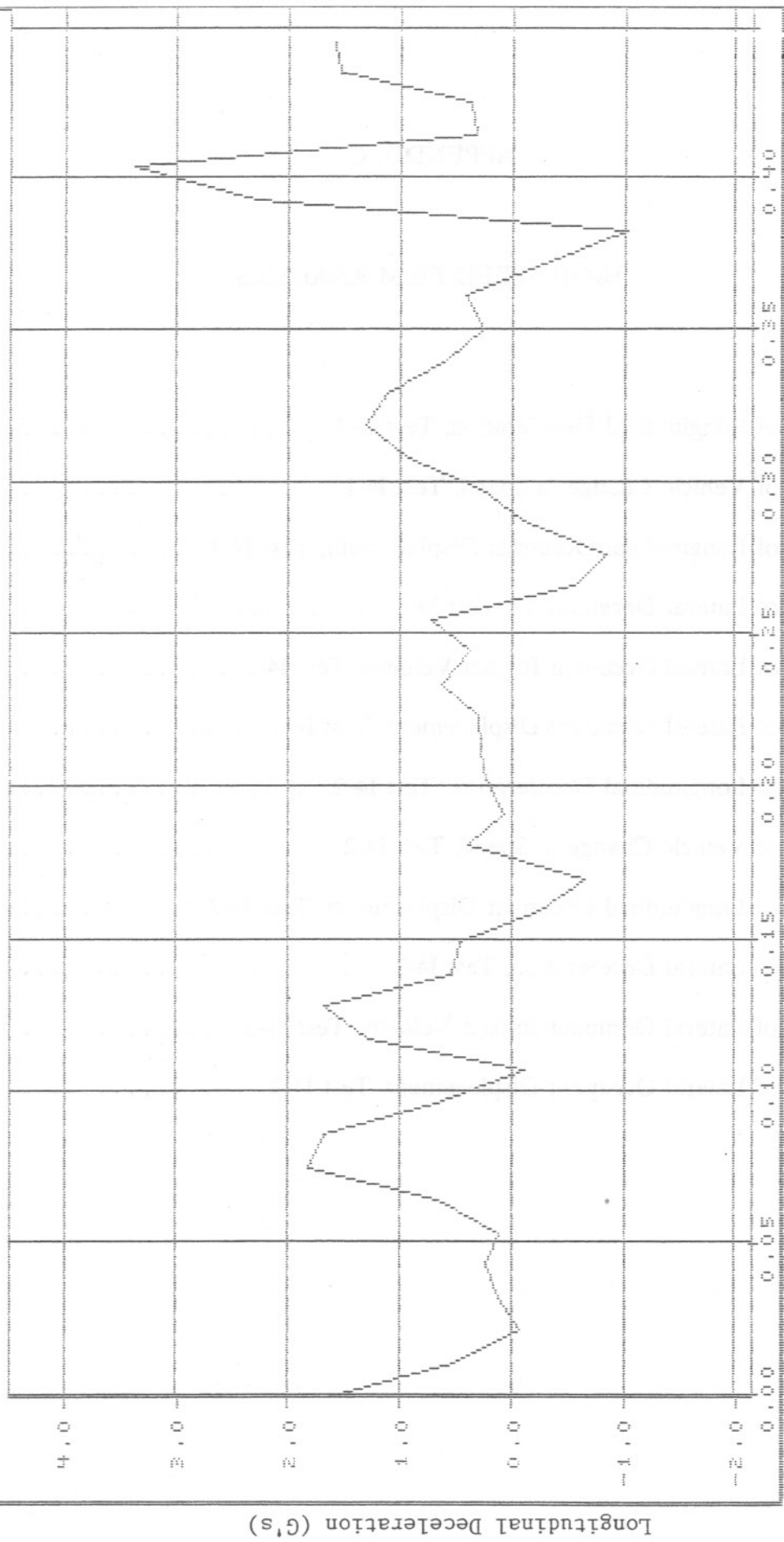

FIGURE C-1. GRAPH OF LONGITUDINAL DECELERATION, TEST I4-1



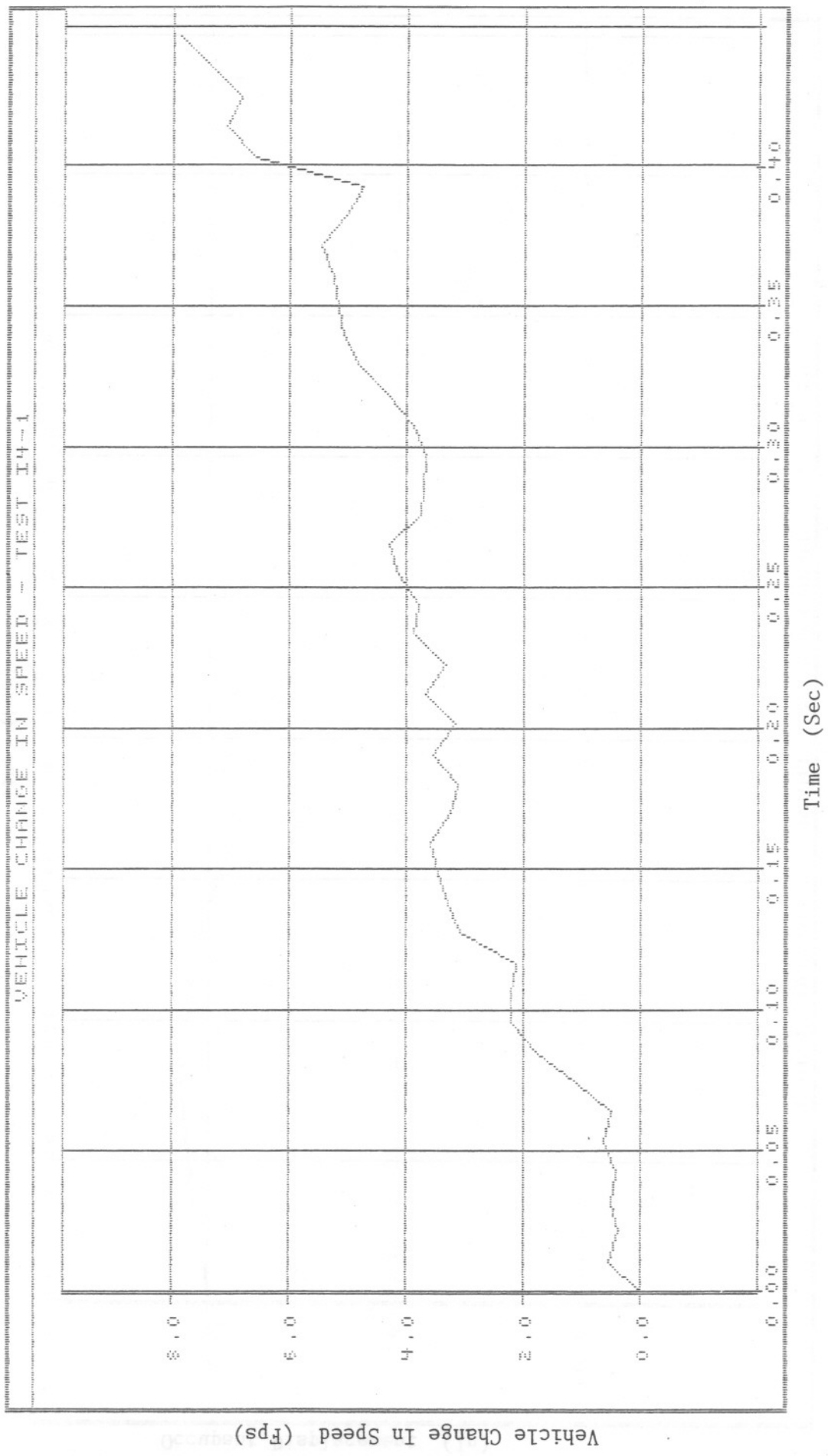

FIGURE C-2. GRAPH OF VEHICLE CHANGE IN SPEED, TEST I4-1

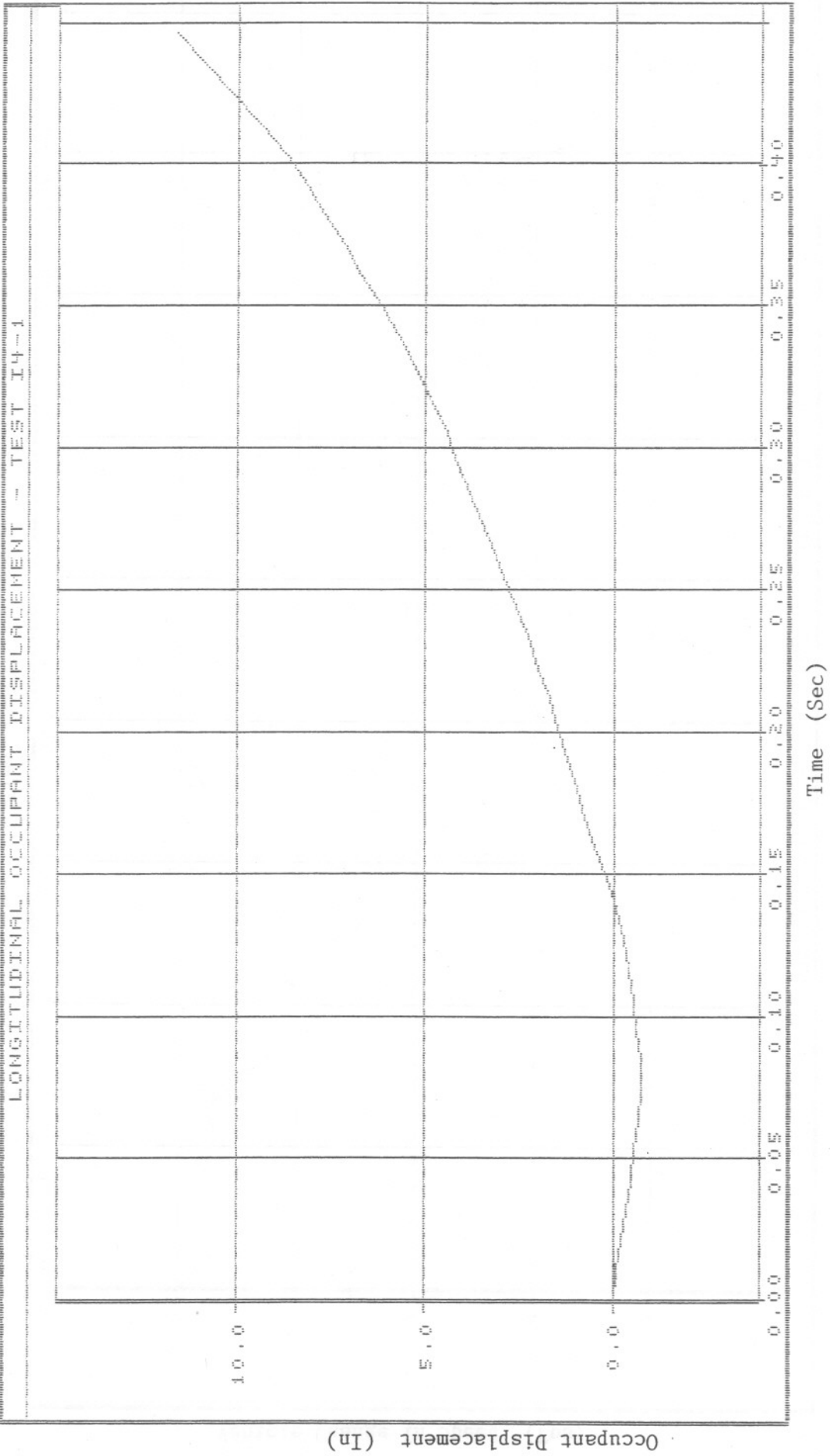

FIGURE C-3. GRAPH OF LONGITUDINAL OCCUPANT DISPLACEMENT, TEST I4-1

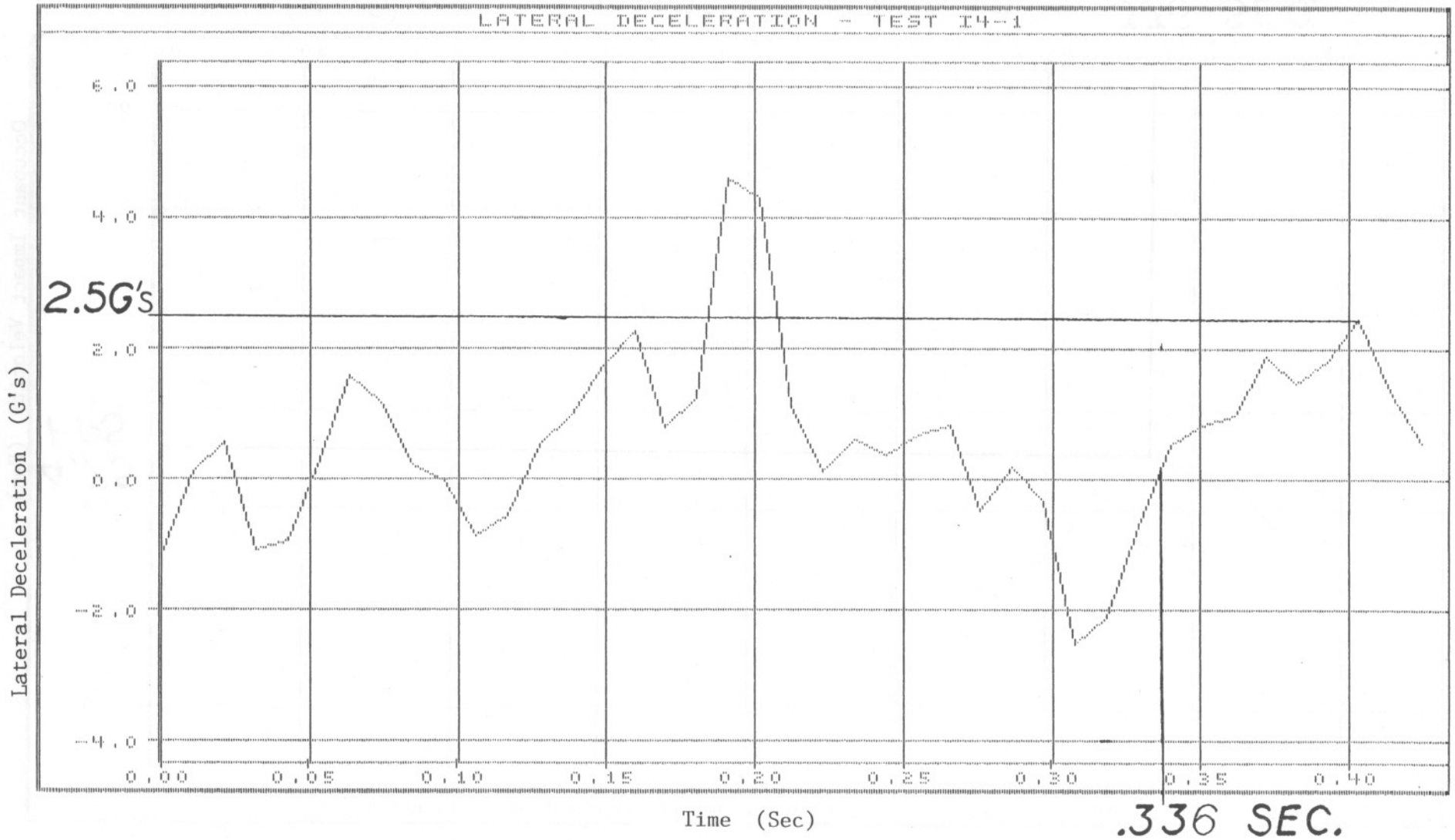
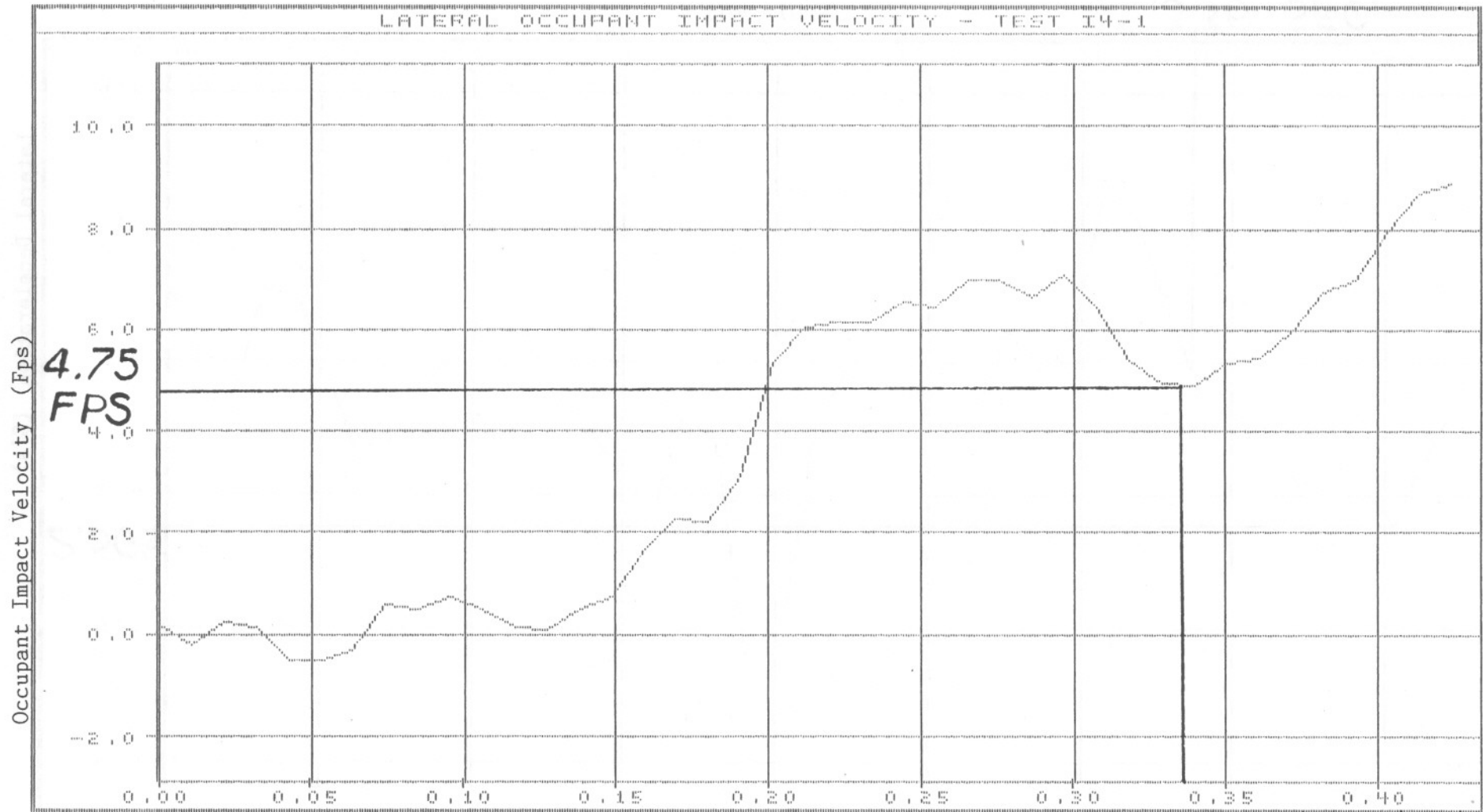

FIGURE C-4. GRAPH OF LATERAL DECELERATION, TEST I4-1



$$(\Delta V)^* = (\Delta V) \frac{(V \sin \theta)_{\text{Target}}}{(V \sin \theta)_{\text{Actual}}} = 4.75 \frac{(50 \sin 15^\circ)}{(46.05 \sin 15.6^\circ)} = 4.96 \text{ FPS Time (Sec) } .336 \text{ SEC.}$$

FIGURE C-5. GRAPH OF LATERAL OCCUPANT IMPACT VELOCITY, TEST I4-1

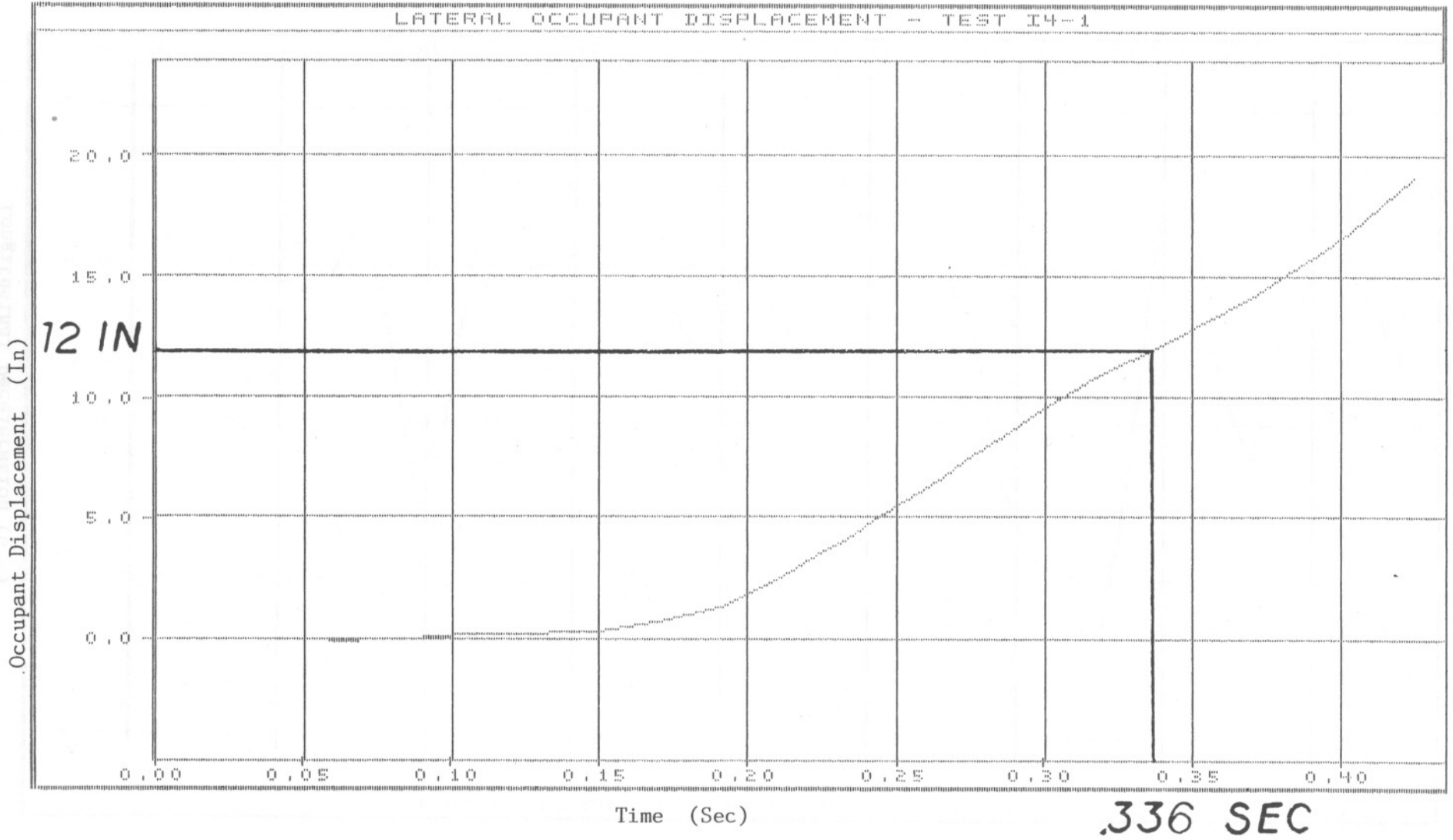

FIGURE C-6. GRAPH OF LATERAL OCCUPANT DISPLACEMENT, TEST I4-1

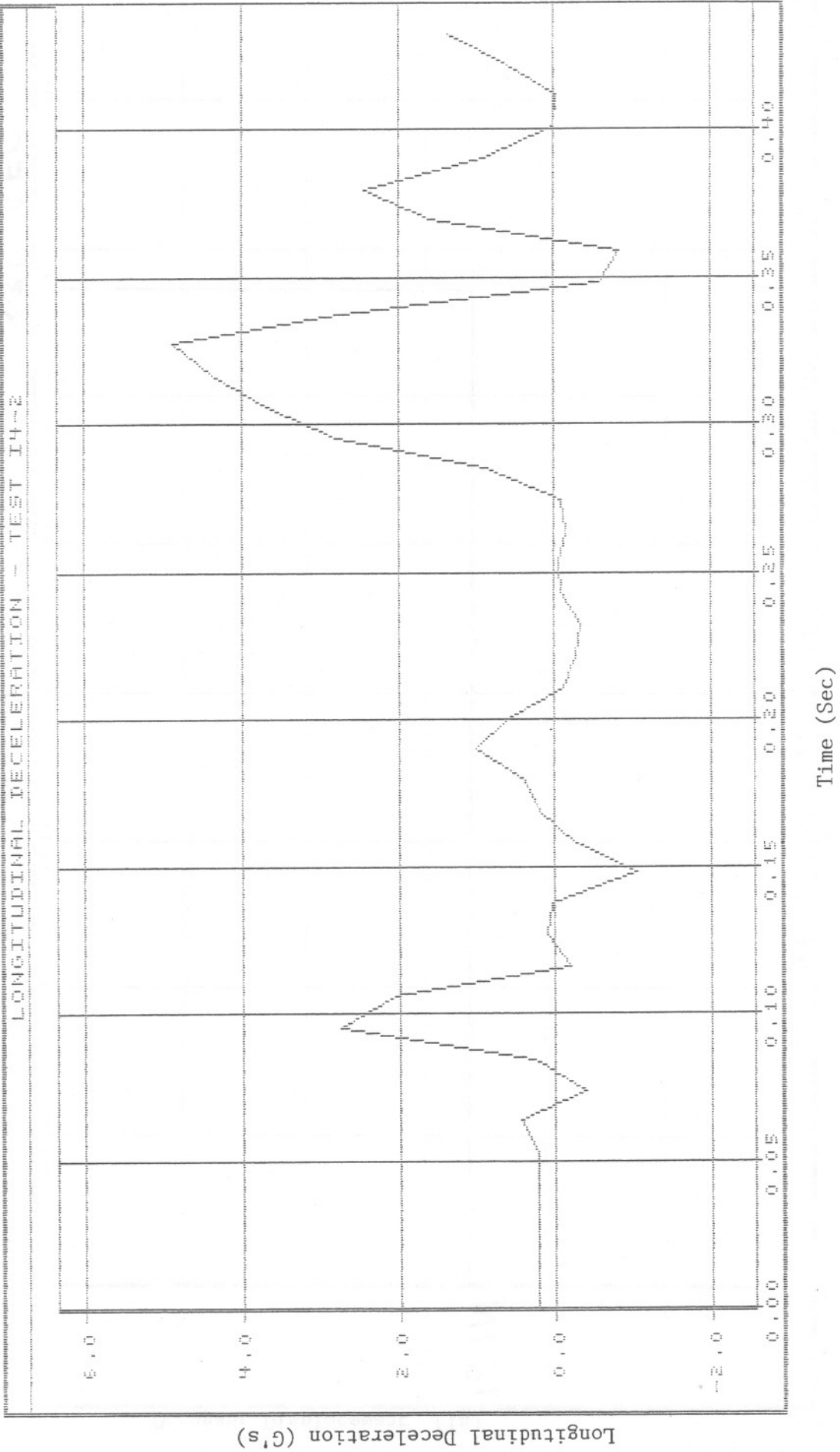
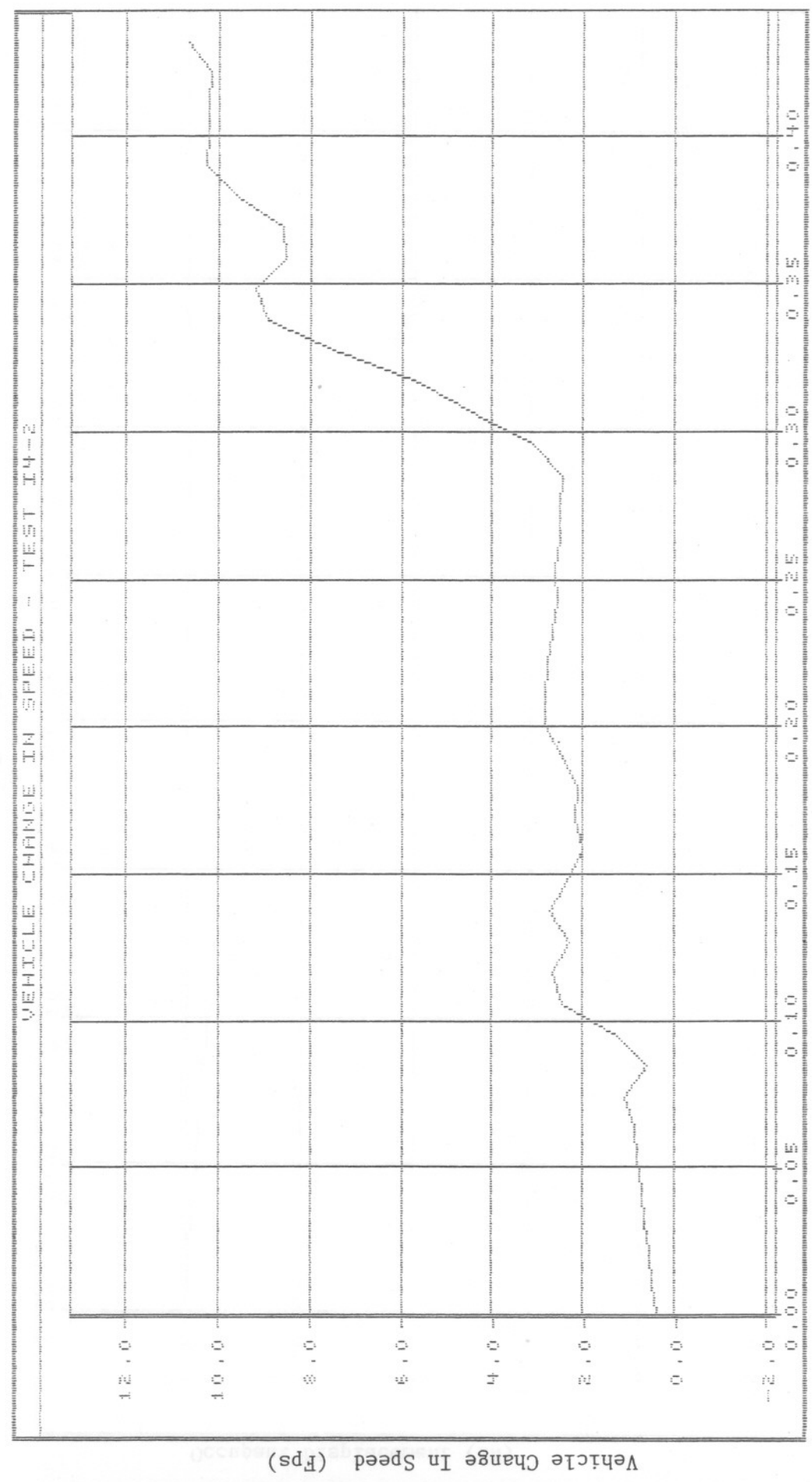

FIGURE C-7. GRAPH OF LONGITUDINAL DECELERATION, TEST I4-2



VEHICLE CHANGE IN SPEED - TEST I4-2



Time (Sec)

FIGURE C-8. GRAPH OF VEHICLE CHANGE IN SPEED, TEST I4-2

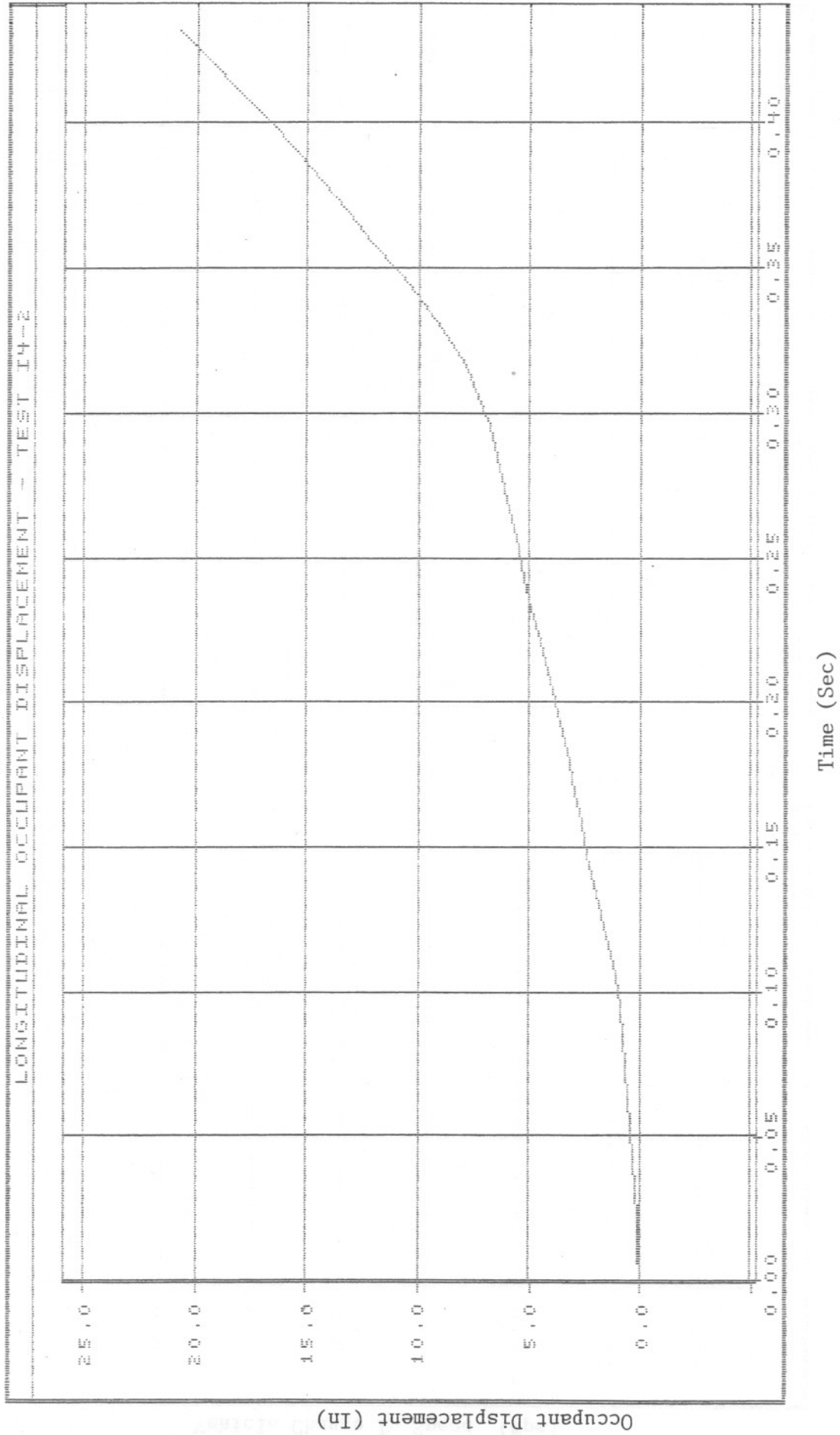

FIGURE C-9. GRAPH OF LONGITUDINAL OCCUPANT DISPLACEMENT, TEST I4-2

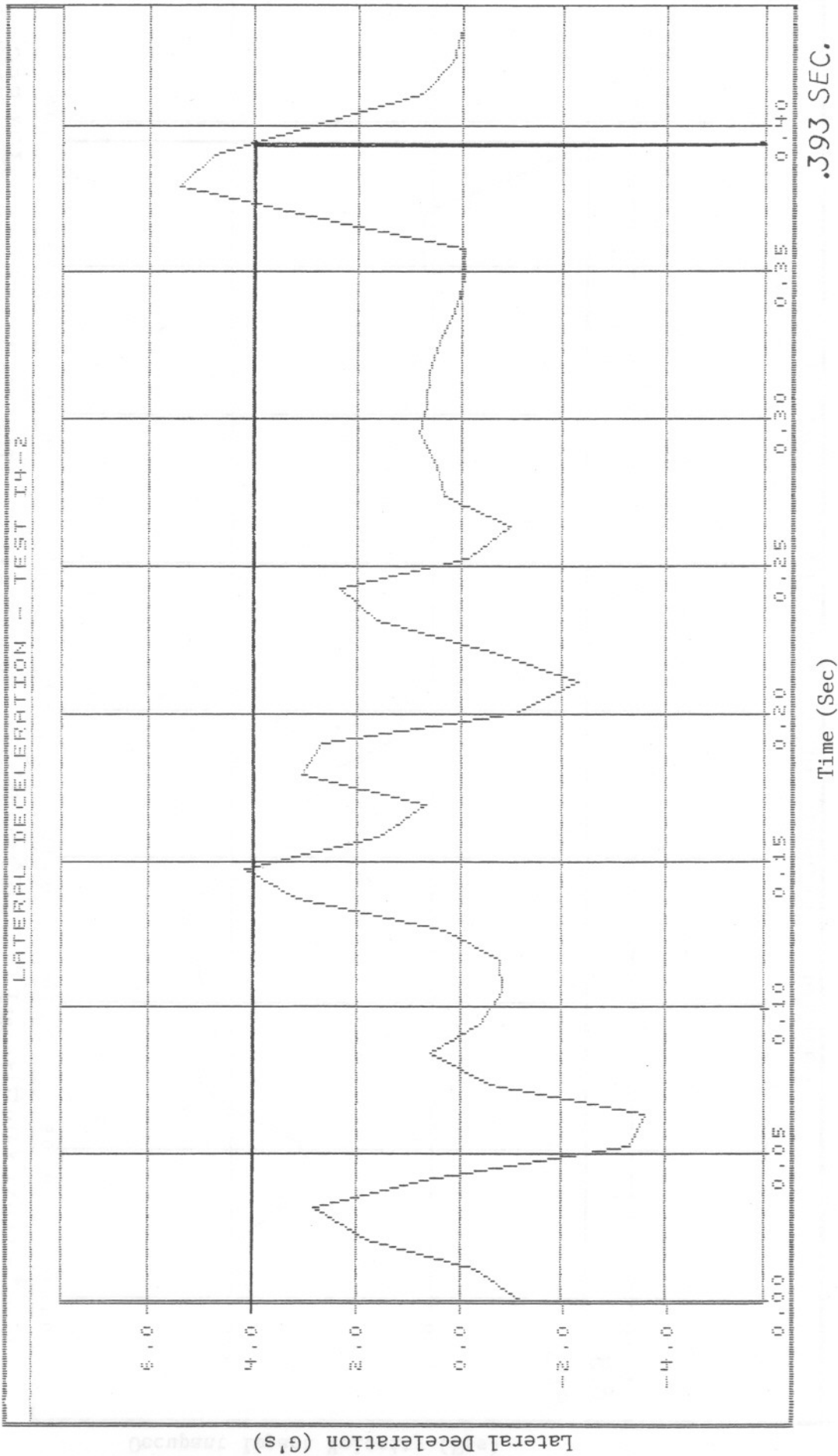

FIGURE C-10. GRAPH OF LATERAL DECELERATION, TEST I4-2

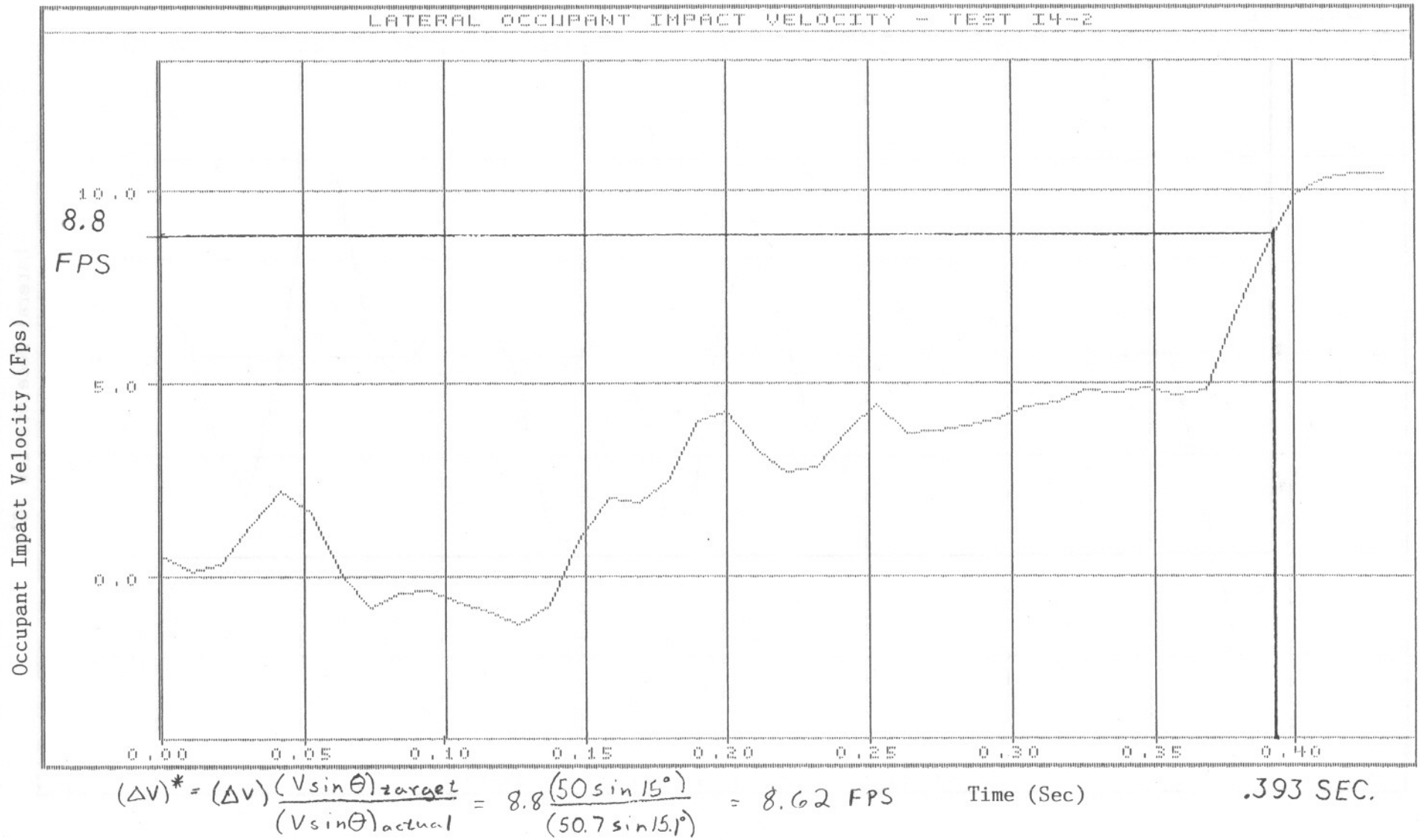

FIGURE C-11. GRAPH OF LATERAL OCCUPANT IMPACT VELOCITY, TEST I4-2

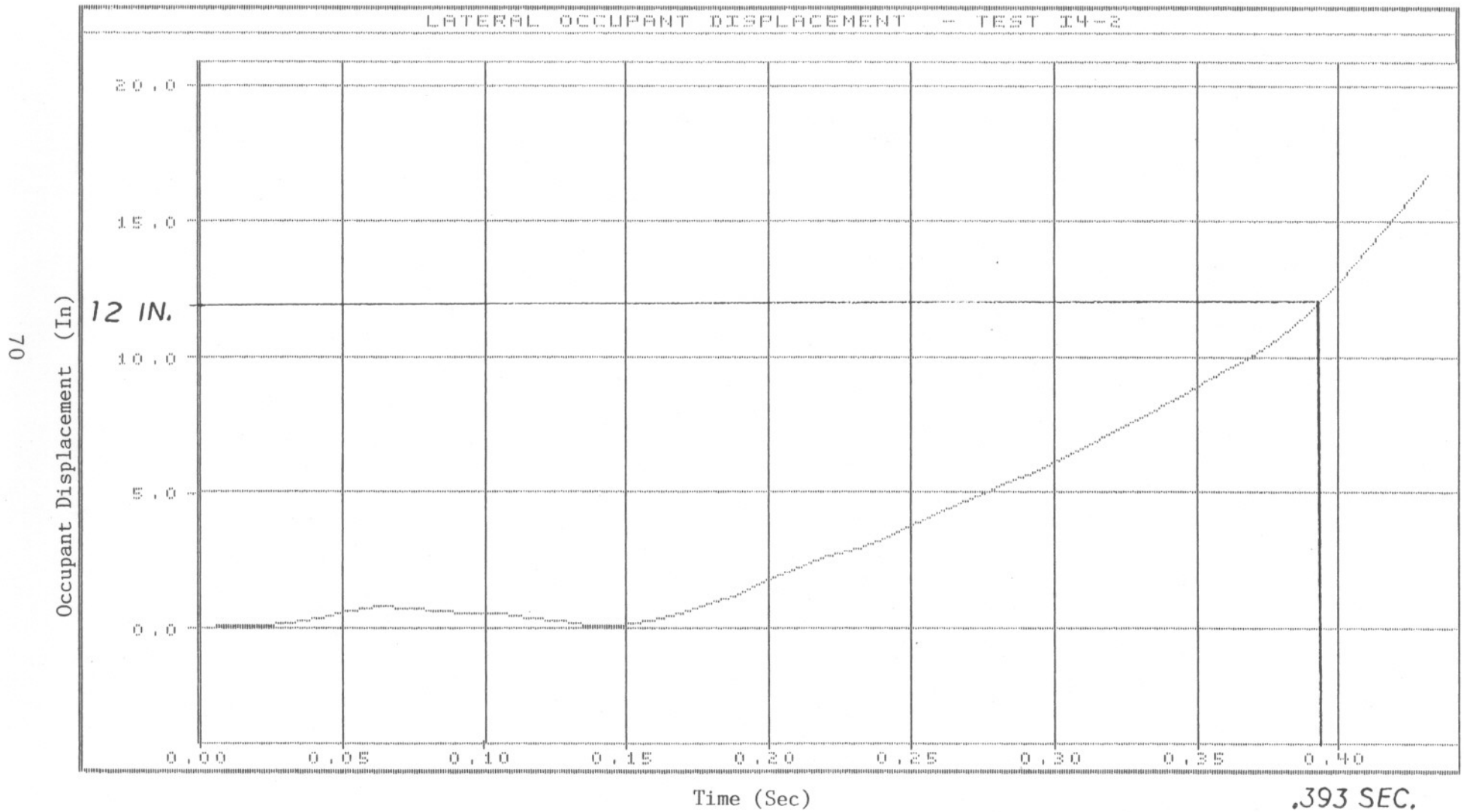

FIGURE C-12. GRAPH OF LATERAL OCCUPANT DISPLACEMENT, TEST I4-2

