



U.S. Department
of Transportation
**Federal Highway
Administration**

March 11, 2008

1200 New Jersey Avenue, SE.
Washington, DC 20590

In Reply Refer To: HSSD/CC-69E

Dean L. Sicking, P.E., Ph.D.
Safety by Design Company
5931 The Knolls
Lincoln, NE 68512

Dear Dr. Sicking:

Thank you for your December 14, 2007, letter requesting Federal Highway Administration (FHWA) acceptance of an extension to the Road Systems, Inc., Single Sided Crash Cushion (SSCC) as a test level 3 (TL-3) device for use on the National Highway System (NHS). You requested that we find the extended SSCC acceptable for use on the NHS under the provisions of National Cooperative Highway Research Program (NCHRP) Report 350 "Recommended Procedures for the Safety Performance Evaluation of Highway Features."

Introduction

The FHWA guidance on crash testing of roadside safety hardware is contained in a memorandum dated July 25, 1997, titled "INFORMATION: Identifying Acceptable Highway Safety Features."

The primary purpose of the request is to provide an end treatment option for bridge rail ends placed close to an intersecting street or driveway that restricts the ability to utilize conventional guardrail designs, such as a short-radius guardrail system. There is no NCHRP Report 350 approved short-radius guardrail system and even the older designs extend as much as 50 ft beyond the end of the bridge railing. There are many situations where there is less than 45 ft available for a barrier end treatment. On the other hand, it is desirable to extend the approach guardrail as far as possible to reduce the risk of a vehicle traveling behind the bridge rail while maintaining adequate end-on safety performance. Most such applications could be treated if the SSCC could be extended up to an additional 16 ft.

The SSCC was originally accepted by FHWA in 2002 (CC-69B) in a soil mounted configuration and in 2004 (CC-69D) in a pavement mounted option. Both of these designs incorporate a 27 ft – 11.5 inch long design with a total of 8 breakaway posts. The spacing between the first and second post was 6 feet 6 inches. The next three posts were spaced 4 feet apart, and the final three posts were reduced to 2 feet apart. It is proposed that the SSCC be lengthened by incorporating additional box beam railing in the 4 foot post spacing region. As shown on the enclosed drawing, extensions of 4, 8, 12, and 16 feet are proposed.



Testing

No additional testing was conducted on the extended SSCC. You claim that the modification would have no adverse effect on the performance of the SSCC. You enumerated the various crash tests that are required for a barrier terminal:

Test 30, Test 31, Test 32, Test 33 all involve end-on impacts. As the proposed change extends the second stage energy absorber, the only effect would be to increase the terminal's energy dissipation capacity for end-on impacts.

Test 34 and Test 35 involve impacts on the side. As the proposed extension does not introduce components that would change the terminal's redirective capacity, there is no need to run either test.

Test 39 is a reverse direction test. As was the case for the same-direction side impacts discussed above, no new design elements are introduced to alter the redirection capability of the device.

Findings

We concur in your claim that the optional extension of the SSCC would not adversely affect the crashworthy performance of the device. Therefore, the requested modification is acceptable for use on the NHS, when permitted by a highway or transportation authority, under the range of conditions the original design was tested.

Please note the following standard provisions that apply to the FHWA letters of acceptance:

- This acceptance is limited to the crashworthiness characteristics of the device(s).
- Any changes that may adversely influence the crashworthiness of the device will require a new acceptance letter.
- Should the FHWA discover that the qualification testing was flawed, that in-service performance reveals unacceptable safety problems, or that the device being marketed is significantly different from the version that was crash tested, it reserves the right to modify or revoke its acceptance.
- You will be expected to supply potential users with sufficient information on design and installation requirements to ensure proper performance.
- You or the manufacturer will be expected to certify to potential users that the hardware furnished has essentially the same chemistry, mechanical properties, and geometry as that submitted for acceptance, and that they will meet the crashworthiness requirements of the FHWA and the NCHRP Report 350.
- To prevent misunderstanding by others, this letter of acceptance, designated as number CC-69E, shall not be reproduced except in full. This letter and the test documentation upon which this letter is based are public information. All such letters and documentation may be reviewed at our office upon request.
- The Single Sided Crash Cushion is a patented device and is considered "proprietary". If proprietary devices are *specified by a highway agency* for use on a Federal-aid project, except exempt, non-NHS projects, they: (a) must be supplied through competitive bidding with equally suitable unpatented items; (b) the highway agency must certify that it is essential for synchronization with existing highway facilities or that no equally suitable

alternative exists; or (c) they must be used for research or for a distinctive type of construction on relatively short sections of road for experimental purposes. Our regulations concerning proprietary products are contained in Title 23, Code of Federal Regulations, Section 635.411, a copy of which is enclosed.

- This acceptance letter shall not be construed as authorization or consent by the FHWA to use, manufacture, or sell any patented device for which the applicant is not the patent holder. The acceptance letter is limited to the crashworthiness characteristics of the candidate device, and the FHWA is neither prepared nor required to become involved in issues concerning patent law. Patent issues, if any, are to be resolved by the applicant.

Sincerely yours,



David A. Nicol, P.E.
Director, Office of Safety Design
Office of Safety

Enclosures

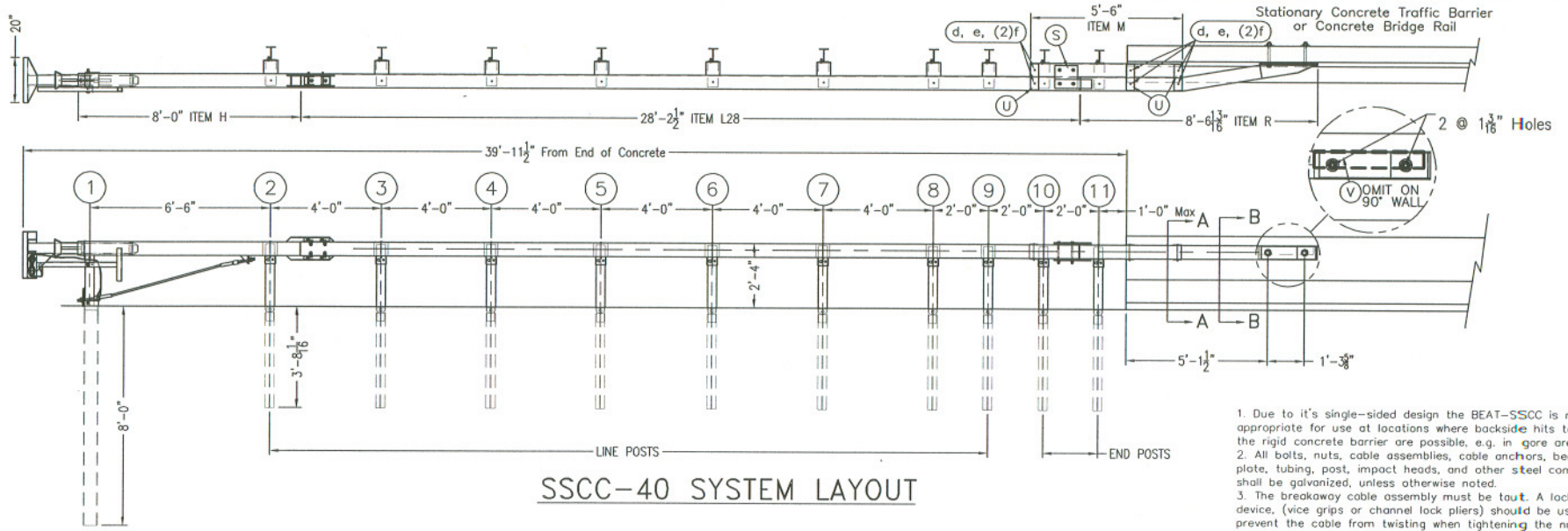

SSCC-40 SYSTEM LAYOUT

1. Due to its single-sided design the BEAT-SSCC is not appropriate for use at locations where backside hits toward the rigid concrete barrier are possible, e.g. in gore areas.
2. All bolts, nuts, cable assemblies, cable anchors, bearing plate, tubing, post, impact heads, and other steel components shall be galvanized, unless otherwise noted.
3. The breakaway cable assembly must be **LAUL**. A locking device, (vice grips or channel lock pliers) should be used to prevent the cable from twisting when tightening the nuts.
4. When site conditions permit, posts may be driven. The lower section of post #1 should not be driven with the upper post section attached. If posts are placed in a drilled hole, the backfill material must be satisfactorily compacted to prevent settlement.
5. If rock excavation is encountered, see manufacturer's installation booklet for installation recommendations.
6. Post shall not be set full depth in concrete.
7. The appropriate connection of the SSCC to the stationary rigid structure is a critical component to insure proper performance of the system. The length of the 1" bolts used to attach the system to the rigid structure will vary with the wall structure and will need to be determined in the field.
8. The approach area in front of the SSCC and the area within the system itself shall be free of fixed obstacles greater than 4 inches in height and have a fill slope or a cut slope of 1V:10H or flatter.
9. Unless otherwise shown in the plans, SSCC rail placed in the vicinity of curbs shall be blocked out so that the face of curb is located directly below the face of rail. The steel posts shall be installed at the proper ground elevation above the gutter pan or roadway surface. Curbs located along or in front of the SSCC system shall not be greater than 4 inches in height.
10. An object marker may be installed on the front of the impact head as specified by the user agency.

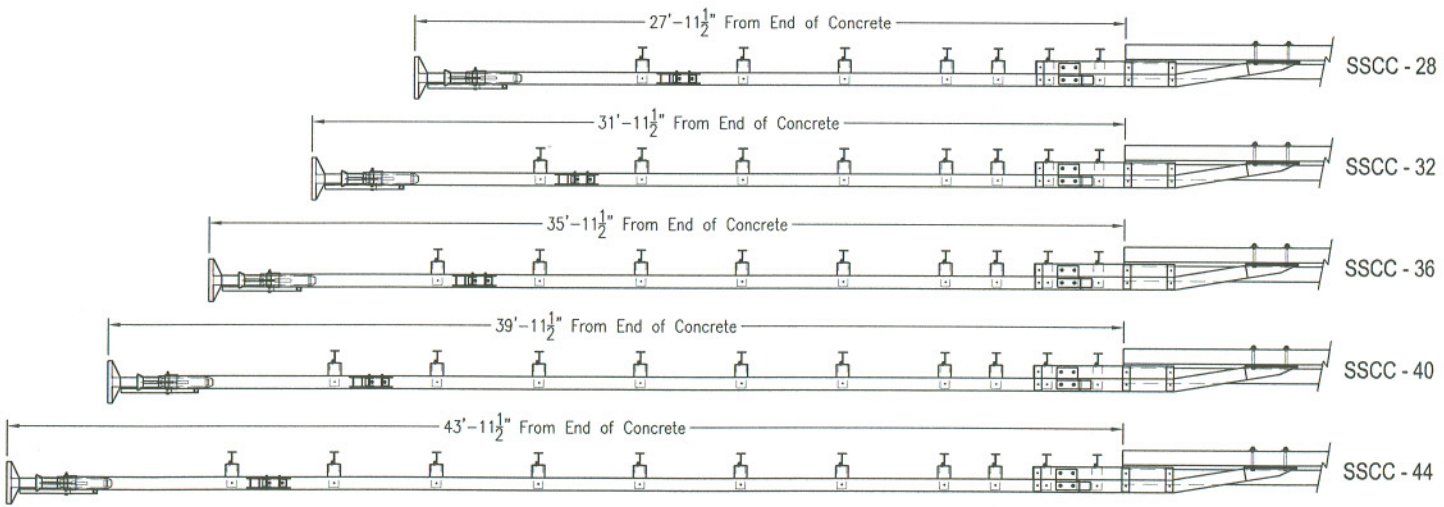

AVAILABLE SYSTEM CONFIGURATIONS

<p>Big Spring, TX Phone: 432-263-2435 or Phone: 330-346-0721</p>	BEAT-SSCC Single Sided Crash Cushion Variable Length System Configurations		Sheet:	S1	
			Date:	11/27/2007	
			By:	JRR	
	Drawing Name:		Scale:	None	Rev:
		BEAT SSCC VAR			

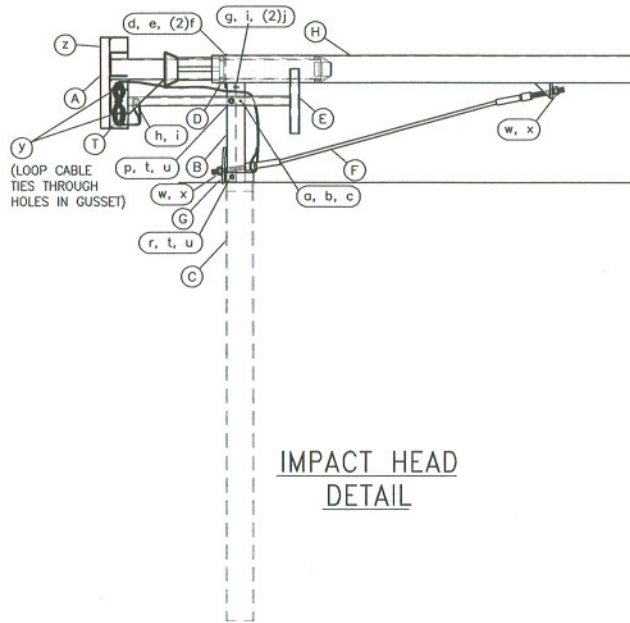

**IMPACT HEAD
DETAIL**

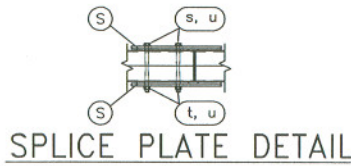

**SPLICE PLATE
DETAIL**

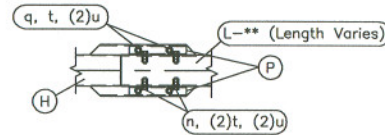

**END SPLICE
DETAIL**

Item P (splice channels) will set on top and bottom of Item L (second rail). The bent plates welded to the end of Item H (end tube rail) will set on top of Item P (splice channels).

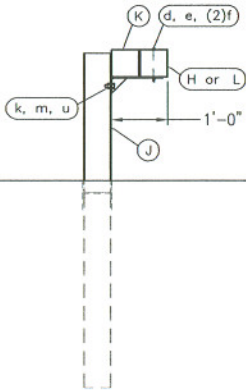

LINE POSTS

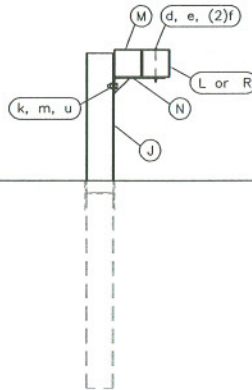

END POSTS (2)

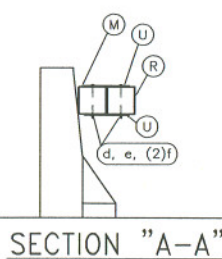

SECTION "A-A"

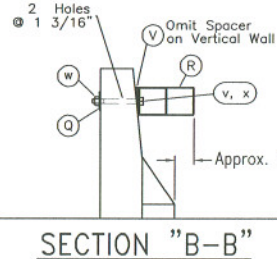

SECTION "B-B"

ITEM	QUANTITY				DESCRIPTION	ITEM NO.	
	SSCC-28	SSCC-32	SSCC-36	SSCC-40			
A	1	1	1	1	Box-Beam Impact Head	B3000	
B	1	1	1	1	Upper End Post - W6x9 x 1'-9 1/2" LG.	BEAT-UP	
C	1	1	1	1	Lower End Post - W6x15 x 8'-0" LG.	BEAT-LP	
D	1	1	1	1	Support Bracket - L4x2 x 4" LG.	BEAT-SB	
E	1	1	1	1	Post Breaker - Welded TS2x2x1/4"	BEAT-PB	
F	1	1	1	1	Cable Anchor Assembly	E770	
G	1	1	1	1	Cable Anchor Bearing Plate	E750	
H	1	1	1	1	End Tube Rail - 8'-0" LG.	B-SS102	
J	7	8	9	10	11	Steel Breakaway Post - W6x9 x 6'-0" LG.	PB621
K	5	6	7	8	9	Support Bracket w/Blockout - TS6x6 w/ Bent PL.	B-SS104
L16						Second Rail - 16'-2 1/2" LG.	B-SS106-16
L20		1				Second Rail - 20'-2 1/2" LG.	B-SS106-20
L24						Second Rail - 24'-2 1/2" LG.	B-SS106-24
L28				1		Second Rail - 28'-2 1/2" LG.	B-SS106-28
L32					1	Second Rail - 32'-2 1/2" LG.	B-SS106-32
M	1	1	1	1	1	Transition Blockout - 5'-6" LG.	B-SS108
N	2	2	2	2	2	Transition Support Bracket - 3/16" Bent PL.	B-SS110
P	2	2	2	2	2	End Tube Splice Channel - 1/4" Bent PL.	BP-SC
Q	2	2	2	2	2	1" Square Washer - 4x4x1/4" PL.	B-SS112
R	1	1	1	1	1	Anchor Rail - 8'-6 1.3/16" LG.	B-SS114
S	2	2	2	2	2	Splice Plate - 10x10x3/8" PL.	B-SS116
T	1	1	1	1	1	3/8" GALV. Cable - 20'-0"	C3820
U	6	6	6	6	6	Tie Plate - 11 1/2 x 3 1/2 x 3/16" PL.	B-SS120
V	1	1	1	1	1	Spacer (OMIT ON 90° WALL)	B-SS122

HARDWARE

a	1	1	1	1	1	1/4" x 3" Hex Bolt Grade 2	B140304
b	1	1	1	1	1	1/4" Hex Nut	N014
c	1	1	1	1	1	1/4" Washer	W014
d	14	15	16	17	18	5/16" x 7 1/2" Hex Bolt Grade 5	B51607504A
e	14	15	16	17	18	5/16" Hex Nut	N0516
f	28	30	32	34	36	5/16" Washer	W0516
g	1	1	1	1	1	1/2" x 2" Hex Bolt Grade 2	B120204
h	1	1	1	1	1	1/2" x 5" Hex Bolt Grade 5	B120504A
i	2	2	2	2	2	1/2" Hex Nut	N012
j	2	2	2	2	2	1/2" Washer	W012
k	7	8	9	10	11	5/8" x 1 1/2" Guardrail Bolt	B580154
m	7	8	9	10	11	5/8" HGR Nut	N050
n	4	4	4	4	4	5/8" x 2" Hex Bolt Grade 5	B580204A
p	1	1	1	1	1	5/8" x 3" Hex Bolt Grade 5	B580304A
q	4	4	4	4	4	5/8" x 6" Hex Bolt Grade 5	B580604A
r	1	1	1	1	1	5/8" x 8" Hex Bolt Grade 5	B580804A
s	4	4	4	4	4	5/8" x 9" Hex Bolt Grade 5	B580904A
t	18	18	18	18	18	5/8" Hex Nut	N055
u	33	34	35	36	37	5/8" Washer	W050
v	2	2	2	2	2	1" x 16" Hex Bolt Grade 5 (Length Varies see Note)	B101604A
w	4	4	4	4	4	1" Hex Nut	N100
x	4	4	4	4	4	1" Washer	W100
y	2	2	2	2	2	Cable Tie	CT100
z	1	1	1	1	1	Object Marker	E3151

Note: Bolt length depends on wall thickness. Anchorage systems that develop the full capacity of the bolt may be used as an alternative to drilling through the concrete section.

<p>Big Spring, TX Phone: 432-863-2435 or Phone: 330-346-0721</p>	BEAT-SSCC Single Sided Crash Cushion		Sheet: S2
	Variable Length Details		Date: 11/27/2007
	Drawing Name: BEAT SSCC VAR		By: JRR
	Scale: None		Rev: 0

§ 635.411

consider all appropriate factors including, but not limited to, cost, administrative burden, and delay that would be imposed if the provision were not waived.

(d) Standard State and Federal-aid contract procedures may be used to assure compliance with the requirements of this section.

[48 FR 53104, Nov. 25, 1983, as amended at 49 FR 18821, May 3, 1984; 58 FR 38975, July 21, 1993]

EDITORIAL NOTE: For a waiver document affecting § 635.410, see 60 FR 15478, Mar. 24, 1995.

§ 635.411 Material or product selection.

(a) Federal funds shall not participate, directly or indirectly, in payment for any premium or royalty on any patented or proprietary material, specification, or process specifically set forth in the plans and specifications for a project, unless:

(1) Such patented or proprietary item is purchased or obtained through competitive bidding with equally suitable unpatented items; or

(2) The State transportation department certifies either that such patented or proprietary item is essential for synchronization with existing highway facilities, or that no equally suitable alternate exists; or

(3) Such patented or proprietary item is used for research or for a distinctive type of construction on relatively short sections of road for experimental purposes.

(b) When there is available for purchase more than one nonpatented, nonproprietary material, semifinished or finished article or product that will fulfill the requirements for an item of work of a project and these available materials or products are judged to be of satisfactory quality and equally acceptable on the basis of engineering analysis and the anticipated prices for the related item(s) of work are estimated to be approximately the same, the PS&E for the project shall either contain or include by reference the specifications for each such material or product that is considered acceptable for incorporation in the work. If the State transportation department wishes to substitute some other acceptable

23 CFR Ch. I (4-1-03 Edition)

material or product for the material or product designated by the successful bidder or bid as the lowest alternate, and such substitution results in an increase in costs, there will not be Federal-aid participation in any increase in costs.

(c) A State transportation department may require a specific material or product when there are other acceptable materials and products, when such specific choice is approved by the Division Administrator as being in the public interest. When the Division Administrator's approval is not obtained, the item will be nonparticipating unless bidding procedures are used that establish the unit price of each acceptable alternative. In this case Federal-aid participation will be based on the lowest price so established.

(d) Appendix A sets forth the FHWA requirements regarding (1) the specification of alternative types of culvert pipes, and (2) the number and types of such alternatives which must be set forth in the specifications for various types of drainage installations.

(e) Reference in specifications and on plans to single trade name materials will not be approved on Federal-aid contracts.

(f) In the case of a design-build project, the following requirements apply: Federal funds shall not participate, directly or indirectly, in payment for any premium or royalty on any patented or proprietary material, specification, or process specifically set forth in the Request for Proposals document unless the conditions of paragraph (a) of this section are applicable.

[41 FR 36204, Aug. 27, 1976, as amended at 67 FR 75926, Dec. 10, 2002]

§ 635.413 Guaranty and warranty clauses.

The STD may include warranty provisions in National Highway System (NHS) construction contracts in accordance with the following:

(a) Warranty provisions shall be for a specific construction product or feature. Items of maintenance not eligible for Federal participation shall not be covered.