

UNLESS OTHERWISE SPECIFIED:
 ALL DIMENSIONS ARE IN INCHES(mm).
 TOLERANCES:
 FRACTIONAL: X/X ± 1/16" [1.4mm]
 DECIMAL: X.X ± .0625
 X.XX ± .032
 DEGREES: ± 0.5°

Traffix Devices Inc.  160 Avenida La Pata
 San Clemente, CA 92673
 (949) 361-5063
 FAX (949) 361-9205
 www.traffixdevices.com

TITLE:
**Big Sandy
 12 Barrel Array**

2. Weight: lbs. [kg]
 1. Units: Inches [mm]
 NOTES: UNLESS OTHERWISE SPECIFIED

DRAWN BY:
 Christopher Jaime
 CHECKED BY:
 FA
 APPROVED BY:
 FA

DATE:
 2/22/17
 DATE:
 2/22/17
 DATE:
 2/22/17

SIZE
B

DWG. NO.
200-100

REV
C

SHEET 1 OF 1

8 7 6 5 4 3 2 1

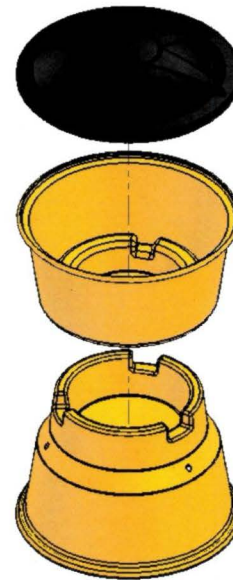
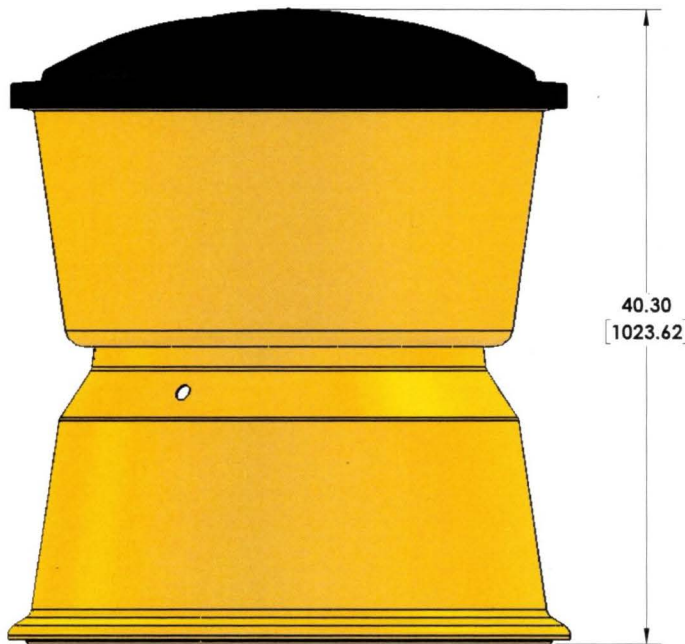

Exploded View



Assembled View

UNLESS OTHERWISE SPECIFIED:
 ALL DIMENSIONS ARE IN INCHES(mm).
 TOLERANCES:
 FRACTIONAL: X/X ± 1/16" [1.4mm]
 DECIMAL: X.X ± .0625"
 X.XX ± .032"
 X.XXX ± .015"
 DEGREES: ± 0.5°



100 Avenida La Pata
 San Clemente, CA 92673
 (949) 361-5865
 FAX (949) 361-9205
 www.traffixdevices.com

TITLE:

Big Sandy Combo Barrel

DRAWN BY:
 Christopher Jaime
 CHECKED BY:
 FA
 APPROVED BY:
 FA

DATE:
 2/23/17
 DATE:
 2/23/17
 DATE:
 2/23/17

SIZE
B

DWG. NO.
200-101

REV
C

SHEET 1 OF 1

1. Units: Inches [mm]
 NOTES: UNLESS OTHERWISE SPECIFIED

8 7 6 5 4 3 2 1

D

D

C

C

B

B

A

A

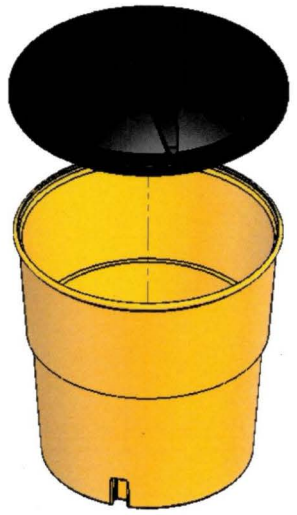
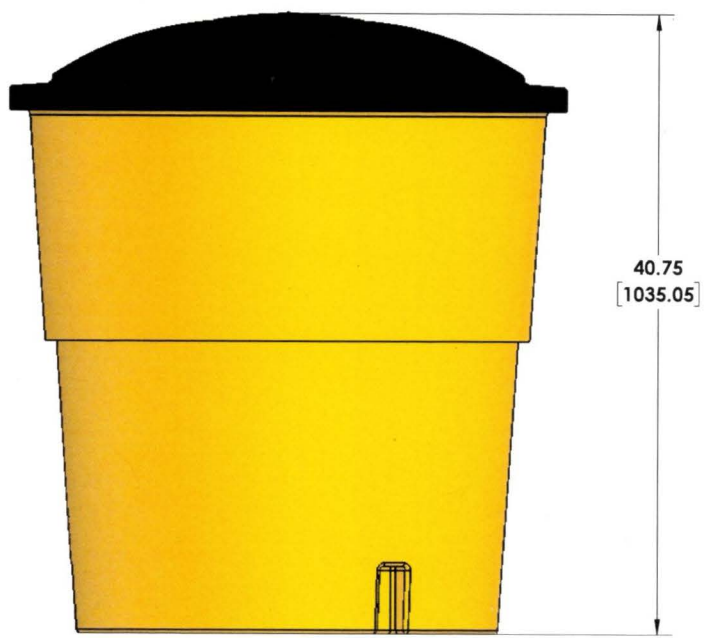

Exploded View

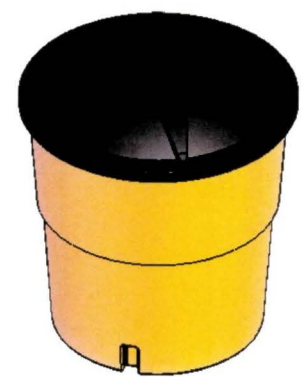

Assembled View

UNLESS OTHERWISE SPECIFIED:
ALL DIMENSIONS ARE IN INCHES(mm).
TOLERANCES:
FRACTIONAL: X/16 ± 1/16" (1.4mm)
DECIMAL: X.X ± .0425"
X.XX ± .032"
X.XXX ± .015"
DEGREES: ± 0.5°



160 Avenida La Pata
San Clemente, CA 92673
(949) 381-5883
FAX (949) 361-9205
www.traffixdevices.com

TITLE:

Big Sandy 1400 lbs. Barrel

1. Units: Inches [mm]
NOTES: UNLESS OTHERWISE SPECIFIED

8 7 6 5 4 3 2 1

DRAWN BY:
Christopher Jaime
CHECKED BY:
FA
APPROVED BY:
FA

DATE:
2/23/17
DATE:
2/23/17
DATE:
2/23/17

SIZE
B

DWG. NO.
200-102

REV
C

SHEET 1 OF 1

8 7 6 5 4 3 2 1

D
C
B
A

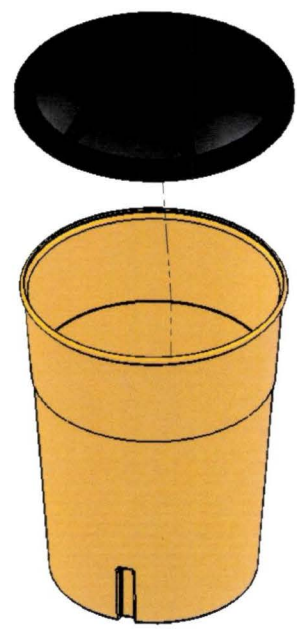
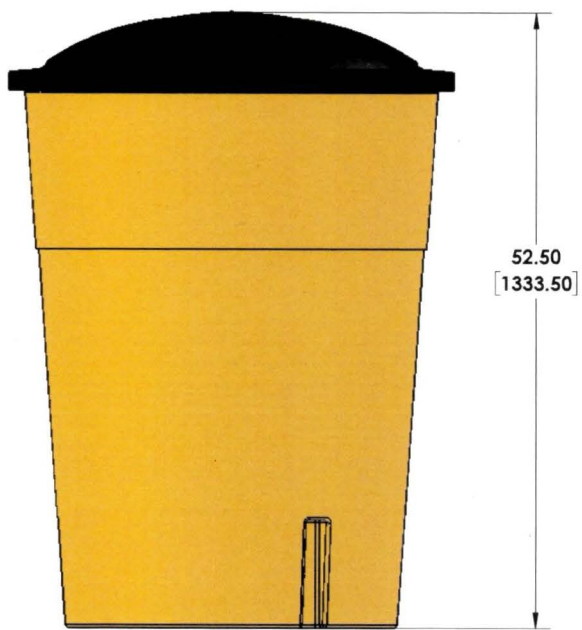

Exploded View



Assembled View

D
C
B
A

1. Units: Inches [mm]
NOTES: UNLESS OTHERWISE SPECIFIED

8 7 6 5 4 3 2 1

UNLESS OTHERWISE SPECIFIED:
ALL DIMENSIONS ARE IN INCHES(mm).
TOLERANCES:
FRACTIONAL: X/16 ± 1/16" (1.4mm)
DECIMAL: X.X ± .0425"
X.XX ± .032"
X.XXX ± .015"
DEGREES: ± 0.5°



160 Avenida La Pata
San Clemente, CA 92673
(949) 361-5665
FAX (949) 361-9205
www.traffixdevices.com

TITLE:
Big Sandy 2100 lbs. Barrel

DRAWN BY:
Christopher Jaime
CHECKED BY:
FA
APPROVED BY:
FA

DATE:
2/23/17
DATE:
2/23/17
DATE:
2/23/17

SIZE
B

DWG. NO.
200-103

REV
C

SHEET 1 OF 1

8 7 6 5 4 3 2 1

D
C
B
A

D
C
B
A

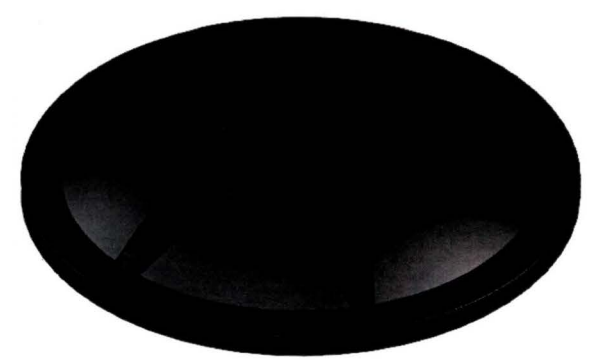
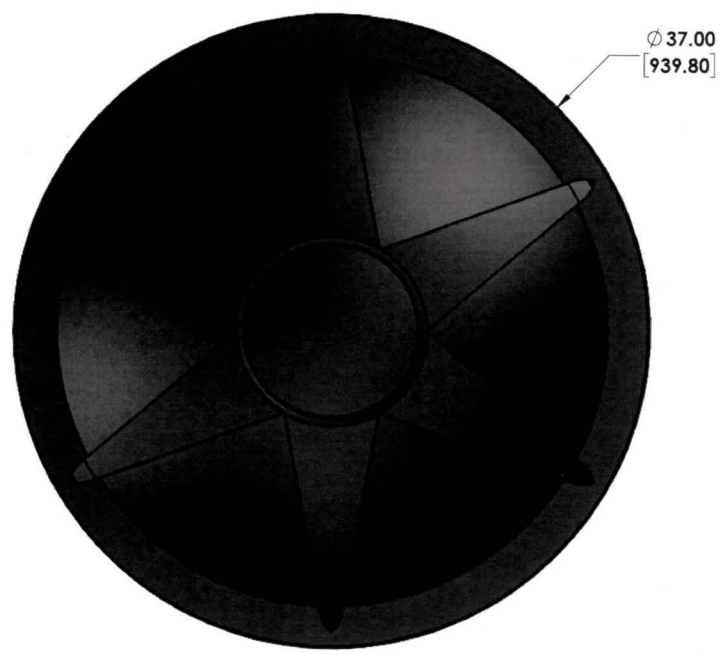

2. Material: Black Polyethylene Plastic
 1. Units: Inches [mm]
 NOTES: UNLESS OTHERWISE SPECIFIED

8 7 6 5 4 3 2 1

UNLESS OTHERWISE SPECIFIED:
 ALL DIMENSIONS ARE IN INCHES[mm].
 TOLERANCES:
 FRACTIONAL: X/X ± 1/16" [1.6mm]
 DECIMAL: X.X ± .0425
 X.XX ± .032"
 DEGREES: ± 0.5°



160 Avenida La Pata
 San Clemente, CA 92673
 (949) 361-5063
 FAX (949) 361-9205
 www.traffixdevices.com

TITLE:
Big Sandy Lid

DRAWN BY:
 Christopher Jaime
 CHECKED BY:
 FA
 APPROVED BY:
 FA

DATE:
 2/27/17
 DATE:
 2/27/17
 DATE:
 2/27/17

SIZE
B

DWG. NO.
200-104

REV
A1

SHEET 1 OF 1

8

7

6

5

4

3

2

1

D

C

B

A

D

C

B

A

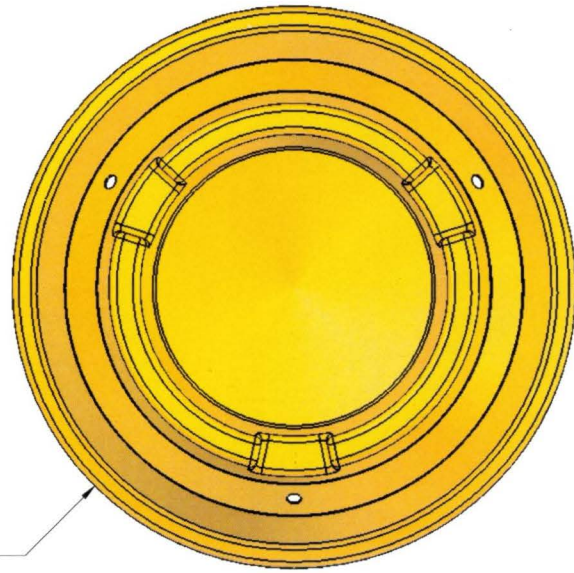

ϕ 37.50
[952.50]

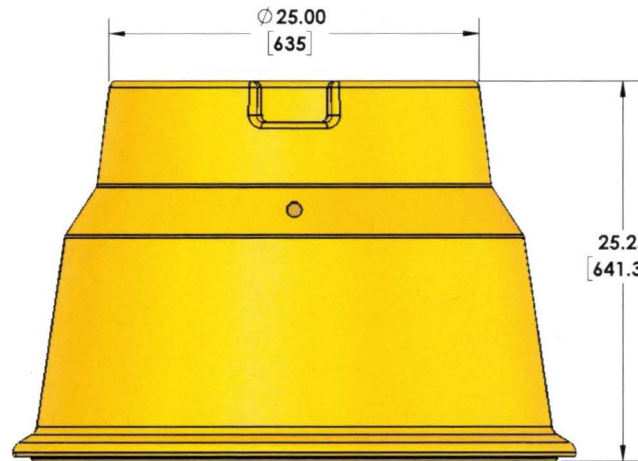

ϕ 25.00
[635]

25.25
[641.35]

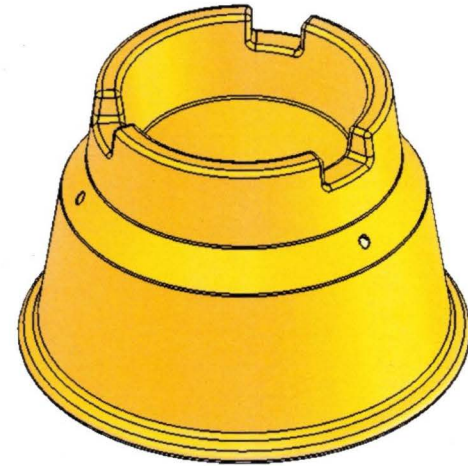

UNLESS OTHERWISE SPECIFIED:
ALL DIMENSIONS ARE IN INCHES(mm).
TOLERANCES:
FRACTIONAL: X/16 ± 1/16" [1.4mm]
DECIMAL: X.X ± .0425
X.XX ± .032"
DEGREES: ± 0.5°



160 Avenida La Plata
San Clemente, CA 92673
(949) 361-5663
FAX (949) 361-9205
www.traffixdevices.com

TITLE:

**Pedestal, Big Sandy
Combo Barrel**

DRAWN BY:
Christopher Jaime
CHECKED BY:
FA
APPROVED BY:
FA

DATE:
7/17/17
DATE:
7/17/17
DATE:
7/17/17

SIZE
B

DWG. NO.
200-105

REV
A

SHEET 1 OF 1

2. Material: Yellow Polyethylene Plastic
1. Units: Inches [mm]
NOTES: UNLESS OTHERWISE SPECIFIED

8

7

6

5

4

3

2

1

8 7 6 5 4 3 2 1

D

D

C

C

B

B

A

A

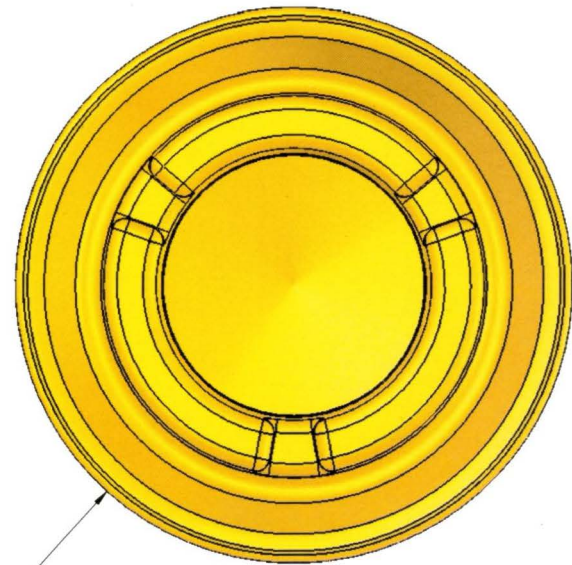

∅ 37.00
939.80

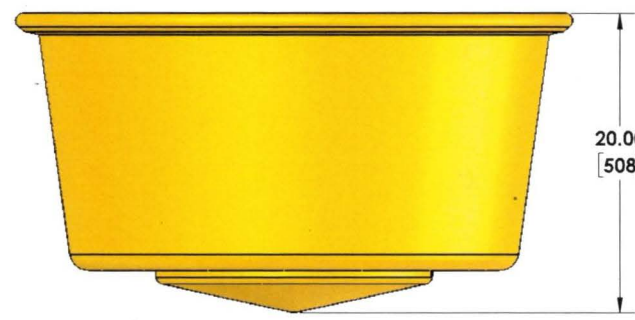
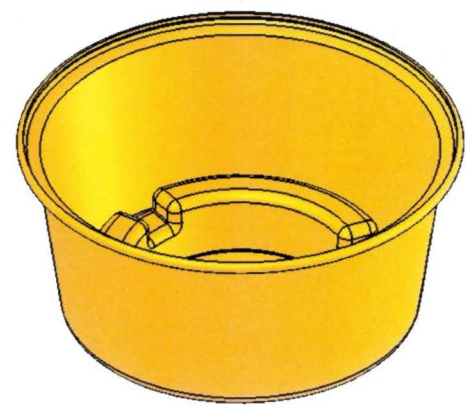

20.00
508

2. Material: Yellow Polyethylene Plastic
1. Units: Inches [mm]
NOTES: UNLESS OTHERWISE SPECIFIED

8 7 6 5 4 3 2 1

UNLESS OTHERWISE SPECIFIED:
ALL DIMENSIONS ARE IN INCHES(mm).
TOLERANCES:
FRACTIONAL: X/16 ± 1/16" [1.4mm]
DECIMAL: X.X ± .0425"
X.XX ± .032"
DEGREES: ± 0.5°



160 Avenida La Pata
San Clemente, CA 92673
(949) 361-5063
FAX (949) 361-9205
www.traffixdevices.com

TITLE:
**Canister, Big Sandy
Combo Barrel**

DRAWN BY:
Christopher Jaime
CHECKED BY:
FA
APPROVED BY:
FA

DATE:
7/17/17
DATE:
7/17/17
DATE:
7/17/17

SIZE
B

DWG. NO.
200-106

REV
A

SHEET 1 OF 1